

SIEMENS



Manual

SIMATIC

S7-1500 / ET 200MP

Digital output module
DQ 16x24VDC/0.5A HF (6ES7522-1BH01-0AB0)

Edition

06/2018

support.industry.siemens.com

SIEMENS

SIMATIC

S7-1500/ET 200MP
Digital output module
DQ 16x24VDC/0.5A HF
(6ES7522-1BH01-0AB0)

Manual

Preface

Documentation guide

1

Product overview

2

Wiring

3

Parameters/address space

4

Interrupts/diagnostics alarms

5

Technical specifications

6

Dimensional drawing

A

Parameter data records

B

Legal information

Warning notice system

This manual contains notices you have to observe in order to ensure your personal safety, as well as to prevent damage to property. The notices referring to your personal safety are highlighted in the manual by a safety alert symbol, notices referring only to property damage have no safety alert symbol. These notices shown below are graded according to the degree of danger.

DANGER

indicates that death or severe personal injury **will** result if proper precautions are not taken.

WARNING

indicates that death or severe personal injury **may** result if proper precautions are not taken.

CAUTION

indicates that minor personal injury can result if proper precautions are not taken.

NOTICE

indicates that property damage can result if proper precautions are not taken.

If more than one degree of danger is present, the warning notice representing the highest degree of danger will be used. A notice warning of injury to persons with a safety alert symbol may also include a warning relating to property damage.

Qualified Personnel

The product/system described in this documentation may be operated only by **personnel qualified** for the specific task in accordance with the relevant documentation, in particular its warning notices and safety instructions. Qualified personnel are those who, based on their training and experience, are capable of identifying risks and avoiding potential hazards when working with these products/systems.

Proper use of Siemens products

Note the following:

WARNING

Siemens products may only be used for the applications described in the catalog and in the relevant technical documentation. If products and components from other manufacturers are used, these must be recommended or approved by Siemens. Proper transport, storage, installation, assembly, commissioning, operation and maintenance are required to ensure that the products operate safely and without any problems. The permissible ambient conditions must be complied with. The information in the relevant documentation must be observed.

Trademarks

All names identified by ® are registered trademarks of Siemens AG. The remaining trademarks in this publication may be trademarks whose use by third parties for their own purposes could violate the rights of the owner.

Disclaimer of Liability

We have reviewed the contents of this publication to ensure consistency with the hardware and software described. Since variance cannot be precluded entirely, we cannot guarantee full consistency. However, the information in this publication is reviewed regularly and any necessary corrections are included in subsequent editions.

Preface

Purpose of the documentation

This manual supplements the system manual S7-1500/ET 200MP (<https://support.industry.siemens.com/cs/ww/en/view/59191792>).

Functions that relate in general to the systems are described in this system manual.

The information provided in this manual and in the system/function manuals supports you in commissioning the systems.

Changes compared to previous version

Compared to the previous version, this manual contains the following change:

- New licensing conditions and copyright information of the Open Source Software
- The module features a switching cycle counter as of firmware version V1.1.0.

Conventions

The term "CPU" is used in this manual both for the CPUs of the S7-1500 automation system and for interface modules of the ET 200MP distributed I/O system.

Please also observe notes marked as follows:

Note

A note contains important information on the product described in the documentation, on the handling of the product or on the section of the documentation to which particular attention should be paid.

Recycling and disposal

For environmentally friendly recycling and disposal of your old equipment, contact a certified electronic waste disposal company and dispose of the equipment according to the applicable regulations in your country.

Security information

Siemens provides products and solutions with industrial security functions that support the secure operation of plants, systems, machines and networks.

In order to protect plants, systems, machines and networks against cyber threats, it is necessary to implement – and continuously maintain – a holistic, state-of-the-art industrial security concept. Siemens' products and solutions constitute one element of such a concept.

Customers are responsible for preventing unauthorized access to their plants, systems, machines and networks. Such systems, machines and components should only be connected to an enterprise network or the internet if and to the extent such a connection is necessary and only when appropriate security measures (e.g. firewalls and/or network segmentation) are in place.

For additional information on industrial security measures that may be implemented, please visit (<https://www.siemens.com/industrialsecurity>).

Siemens' products and solutions undergo continuous development to make them more secure. Siemens strongly recommends that product updates are applied as soon as they are available and that the latest product versions are used. Use of product versions that are no longer supported, and failure to apply the latest updates may increase customers' exposure to cyber threats.

To stay informed about product updates, subscribe to the Siemens Industrial Security RSS Feed under (<https://www.siemens.com/industrialsecurity>).

Open Source Software

Open-source software is used in the firmware of the I/O modules. Open Source Software is provided free of charge. We are liable for the product described, including the open-source software contained in it, pursuant to the conditions applicable to the product. Siemens accepts no liability for the use of the open source software over and above the intended program sequence, or for any faults caused by modifications to the software.

For legal reasons, we are obliged to publish the original text of the license conditions and copyright notices. Please read the information relating to this on the Internet (<https://support.industry.siemens.com/cs/ww/en/view/109757558>).

Table of contents

	Preface	3
1	Documentation guide	6
2	Product overview	10
	2.1 Properties.....	10
	2.2 Functions	13
	2.2.1 Switching cycle counter	13
3	Wiring	15
4	Parameters/address space	17
	4.1 Parameters	17
	4.2 Description of parameters.....	19
	4.3 Address space	20
5	Interrupts/diagnostics alarms.....	25
	5.1 Status and error displays	25
	5.2 Interrupts.....	27
	5.3 Diagnostics alarms.....	28
6	Technical specifications	29
A	Dimensional drawing.....	34
	A.1 Dimensional drawing.....	34
B	Parameter data records.....	36
	B.1 Parameter assignment.....	36
	B.2 Structure of parameter data sets DS 64 - 79	38
	B.3 Structure of data set DS 129	39
	B.4 Structure of data set DS 130	41
	B.5 Structure of data set DS 131	43

Documentation guide

The documentation for the SIMATIC S7-1500 automation system and the SIMATIC ET 200MP distributed I/O system is arranged into three areas. This arrangement enables you to access the specific content you require.

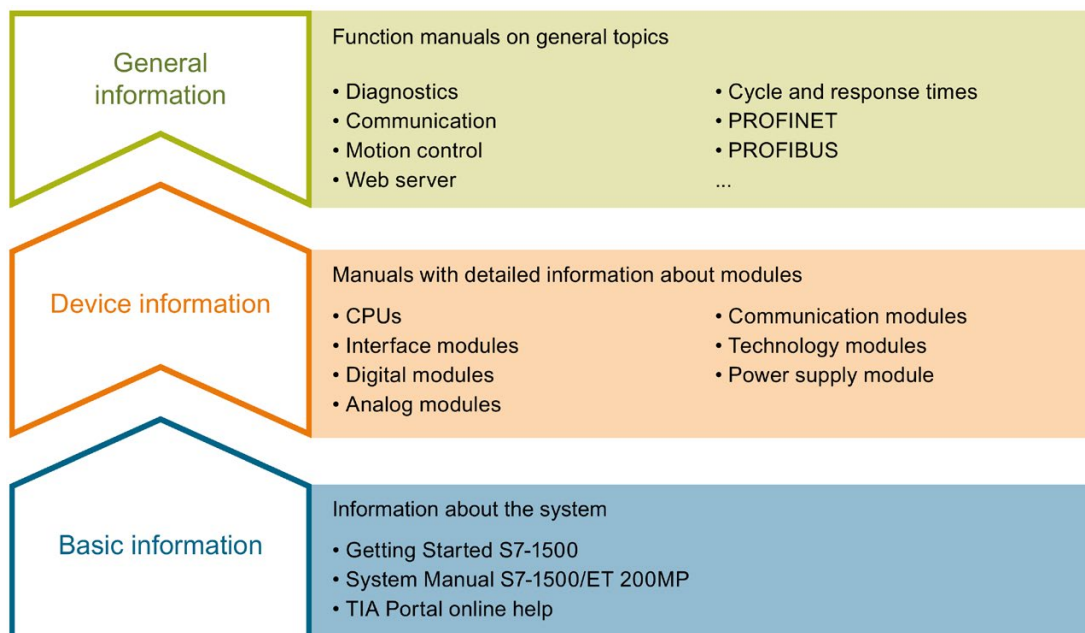

Basic information

The System Manual and Getting Started describe in detail the configuration, installation, wiring and commissioning of the SIMATIC S7-1500 and ET 200MP systems. The STEP 7 online help supports you in the configuration and programming.

Device information

Product manuals contain a compact description of the module-specific information, such as properties, wiring diagrams, characteristics and technical specifications.

General information

The function manuals contain detailed descriptions on general topics regarding the SIMATIC S7-1500 and ET 200MP systems, e.g. diagnostics, communication, motion control, Web server, OPC UA.

You can download the documentation free of charge from the Internet (<https://support.industry.siemens.com/cs/ww/en/view/109742691>).

Changes and supplements to the manuals are documented in a Product Information.

You can download the product information free of charge from the Internet (<https://support.industry.siemens.com/cs/us/en/view/68052815>).

Manual Collection S7-1500/ET 200MP

The Manual Collection contains the complete documentation on the SIMATIC S7-1500 automation system and the ET 200MP distributed I/O system gathered together in one file.

You can find the Manual Collection on the Internet (<https://support.industry.siemens.com/cs/ww/en/view/86140384>).

SIMATIC S7-1500 comparison list for programming languages

The comparison list contains an overview of which instructions and functions you can use for which controller families.

You can find the comparison list on the Internet (<https://support.industry.siemens.com/cs/ww/en/view/86630375>).

"mySupport"

With "mySupport", your personal workspace, you make the best out of your Industry Online Support.

In "mySupport", you can save filters, favorites and tags, request CAx data and compile your personal library in the Documentation area. In addition, your data is already filled out in support requests and you can get an overview of your current requests at any time.

You must register once to use the full functionality of "mySupport".

You can find "mySupport" on the Internet (<https://support.industry.siemens.com/My/ww/en>).

"mySupport" - Documentation

In the Documentation area in "mySupport" you can combine entire manuals or only parts of these to your own manual.

You can export the manual as PDF file or in a format that can be edited later.

You can find "mySupport" - Documentation on the Internet (<http://support.industry.siemens.com/My/ww/en/documentation>).

"mySupport" - CAx data

In the CAx data area in "mySupport", you can access the current product data for your CAx or CAe system.

You configure your own download package with a few clicks.

In doing so you can select:

- Product images, 2D dimension drawings, 3D models, internal circuit diagrams, EPLAN macro files
- Manuals, characteristics, operating manuals, certificates
- Product master data

You can find "mySupport" - CAx data on the Internet (<http://support.industry.siemens.com/my/ww/en/CAxOnline>).

Application examples

The application examples support you with various tools and examples for solving your automation tasks. Solutions are shown in interplay with multiple components in the system - separated from the focus on individual products.

You will find the application examples on the Internet (<https://support.industry.siemens.com/sc/ww/en/sc/2054>).

TIA Selection Tool

With the TIA Selection Tool, you can select, configure and order devices for Totally Integrated Automation (TIA).

This tool is the successor of the SIMATIC Selection Tool and combines the known configurators for automation technology into one tool.

With the TIA Selection Tool, you can generate a complete order list from your product selection or product configuration.

You can find the TIA Selection Tool on the Internet (<http://w3.siemens.com/mcms/topics/en/simatic/tia-selection-tool>).

SIMATIC Automation Tool

You can use the SIMATIC Automation Tool to perform commissioning and maintenance activities simultaneously on various SIMATIC S7 stations as a bulk operation independent of the TIA Portal.

General function overview:

- Network browsing and creation of a table showing the accessible devices in the network.
- Flashing of device LEDs or HMI display to locate a device
- Downloading of addresses (IP, subnet, gateway) to a device
- Downloading the PROFINET name (station name) to a device
- Placing a CPU in RUN or STOP mode
- Setting the time in a CPU to the current time of your PG/PC
- Downloading a new program to a CPU or an HMI device
- Downloading from CPU, downloading to CPU or deleting recipe data from a CPU
- Downloading from CPU or deleting data log data from a CPU
- Backup/restore of data from/to a backup file for CPUs and HMI devices
- Downloading service data from a CPU
- Reading the diagnostics buffer of a CPU
- Performing a CPU memory reset
- Resetting devices to factory settings
- Downloading a firmware update to a device

You can find the SIMATIC Automation Tool on the Internet (<https://support.industry.siemens.com/cs/ww/en/view/98161300>).

PRONETA

With SIEMENS PRONETA (PROFINET network analysis), you analyze the PROFINET network during commissioning. PRONETA features two core functions:

- The topology overview independently scans PROFINET network and all connected components.
- The IO check is a fast test of the wiring and the module configuration of a system.

You can find SIEMENS PRONETA on the Internet

(<https://support.industry.siemens.com/cs/ww/en/view/67460624>).

SINETPLAN

SINETPLAN, the Siemens Network Planner, supports you in planning automation systems and networks based on PROFINET. The tool facilitates professional and predictive dimensioning of your PROFINET installation as early as in the planning stage. In addition, SINETPLAN supports you during network optimization and helps you to exploit network resources optimally and to plan reserves. This helps to prevent problems in commissioning or failures during productive operation even in advance of a planned operation. This increases the availability of the production plant and helps improve operational safety.

The advantages at a glance

- Network optimization thanks to port-specific calculation of the network load
- Increased production availability thanks to online scan and verification of existing systems
- Transparency before commissioning through importing and simulation of existing STEP 7 projects
- Efficiency through securing existing investments in the long term and optimal exploitation of resources

You can find SINETPLAN on the Internet (<https://www.siemens.com/sinetplan>).

Product overview

2.1 Properties

Article number

6ES7522-1BH01-0AB0

View of the module

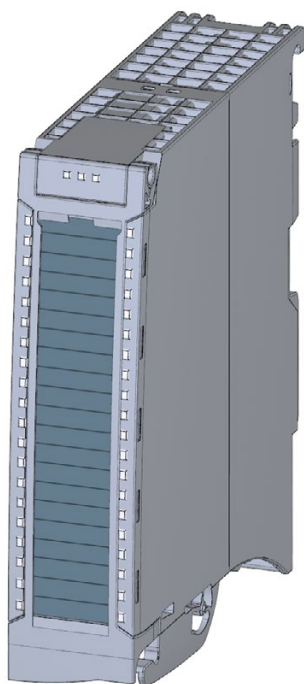

Figure 2-1 View of the DQ 16x24VDC/0.5A HF module

Properties

The module has the following technical properties:

- 16 digital outputs, electrically isolated in groups of 8
- Rated output voltage 24 V DC
- Rated output current 0.5 A per channel
- Configurable substitute values (per channel)
- Configurable diagnostics (per channel)
- Suitable for solenoid valves, DC contactors, and indicator lights
- Switching cycle counter for connected actuators, e.g. solenoid valves
- Hardware compatible with digital output module DQ 16x24VDC/0.5A ST (6ES7522-1BH00-0AB0).

The module supports the following functions:

Table 2- 1 Version dependencies of the module functions

Function	Firmware version of the module	Configuration software	
		STEP 7 (TIA Portal) as of V13, SP1 with HSP 0143	GSD file in STEP 7 (TIA Portal) V12 or higher, or STEP 7 V5.5 SP3 or higher
Firmware update	V1.0.0 or higher	X	--- / X
Identification data I&M0 to I&M3	V1.0.0 or higher	X	X
Parameter assignment in RUN	V1.0.0 or higher	X	X
Isochronous mode	V1.0.0 or higher	X	---
Module-internal Shared Output (MSO)	V1.0.0 or higher	X (PROFINET IO only)	X (PROFINET IO only)
Configurable submodules / sub-modules for Shared Device	V1.0.0 or higher	X (PROFINET IO only)	X (PROFINET IO only)
Switching cycle counter	V1.1.0 or higher	as of V15.0 with HSP0247 <ul style="list-style-type: none"> • PROFINET IO only • Central operation with a S7-1500 CPU is supported 	X (PROFINET IO only)

You can configure the module with STEP 7 (TIA Portal) and with a GSD file.

Compatibility

The following table shows the compatibility of the modules and the dependencies between hardware functional status (FS) and firmware version (FW) used:

Hardware functional status	Firmware version	Note
FS01	V1.0.0	Upgrade to V1.1.0 not possible
FS02	V1.1.0	Upgrade and downgrade possible between V1.1.0 and higher

Accessories

The following accessories are supplied with the module and can also be ordered separately as spare parts:

- Labeling strips
- U connector
- Universal front cover

Other components

The following component can be ordered separately:

Front connectors, including potential jumpers and cable ties

You can find additional information on accessories in the system manual S7-1500/ET 200MP (<https://support.industry.siemens.com/cs/ww/en/view/59191792>).

2.2 Functions

2.2.1 Switching cycle counter

The function records the number of switching cycles of the output and thus the switching cycles of a connected actuator, such as those of solenoid valves. When the specified number of switching cycles is reached, the "Limit value warning" maintenance interrupt is triggered, provided it is configured and enabled. When replacing the actuator, you can reset the switching cycle counter from the user program.

When replacing modules, you have the option of pre-initializing the switching cycle counter from the user program.

Typical areas of application:

- Recording the number of switching cycles of the connected devices, e.g. solenoid valves or load contactors
- Predictive maintenance

Advantages

- You configure this function instead of programming.
- "Monitoring" of each individual channel is possible. You can select which outputs are "monitored".
- You can adapt the plant configuration flexibly and individually.
- Easy to service and maintain. You can enable and disable the switching cycle counter via the user program.
- Increase in plant availability. You can schedule actuator replacement in advance for the next maintenance cycle.

Requirement

Firmware version as of V1.1.0 of the module.

Configuration

You configure the switching cycle counter with the following parameters:

- Switching cycle counter enabled/disabled
- Trigger maintenance interrupt when the limit is reached
- Set limit for maintenance interrupt

How it works

The module counts the switching cycles by evaluating the rising edges of an output signal. If the module detects a rising edge, the switching cycle counter (24-bit) for the respective channel is incremented. After an overflow of the switching cycle counter, it starts again with 0.

If you activate the "Maintenance switching cycles" parameter, the "Limit warning" of the maintenance interrupt is triggered when the limit is exceeded. Alternatively, activate the maintenance interrupt in the parameter data sets starting at DS 64.

The current counter states are stored on the module cyclically (approx. every 20 seconds) and retentively. The switching cycle counters are reset each time the module is restarted (power off/on).

You activate the function with the "Switching cycle counter" parameter or in the parameter data sets starting at DS 64.

You can read the current counter states with data set DS 129. Data set DS 129 contains the counter status for each channel in UDINT format.

You can read the limits for each channel in UDINT format with data set DS 130.

Data set DS 131 enables you to overwrite the current counter value for each switching cycle counter.

You can set a limit for each switching cycle counter with the "Switching cycle limit" parameter or with data set DS 131.

Wiring

This section contains the block diagram of the module and outlines various wiring options.

You can find information on wiring the front connector, establishing a cable shield, etc. in the system manual S7-1500/ET 200MP

(<https://support.industry.siemens.com/cs/ww/en/view/59191792>).

Wiring and block diagram

The example in the following figure shows the terminal assignment and the assignment of the channels to the addresses (output byte a and output byte b).

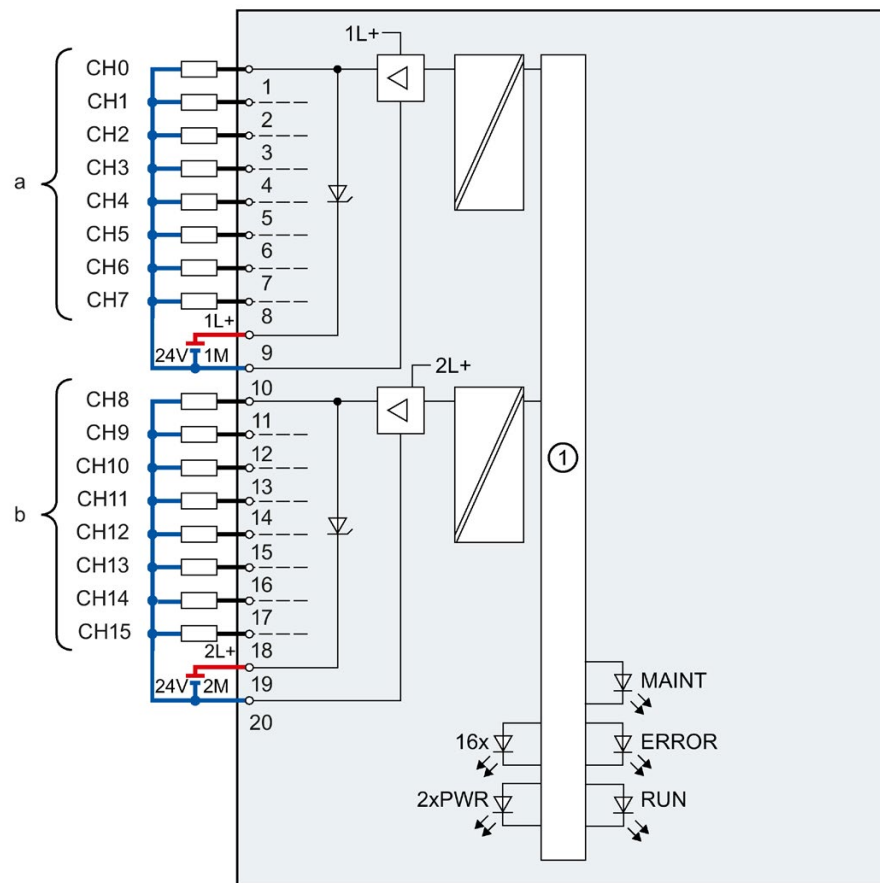

①	Backplane bus interface	MAINT	LED maintenance display (yellow)
xL+	Supply voltage 24 V DC	RUN	Status display LED (green)
xM	Ground	ERROR	Error display LED (red)
CHx	Channel or channel status LED (green/red)	PWR	POWER supply voltage LED (green)

Figure 3-1 Block diagram and terminal assignment

Note

When the 24 V supply voltage is switched on at each channel, there is a "1" signal at the module outputs for approx. 50 μ s.

Tip: Using the potential jumpers

If you want to supply both load groups with the same potential (non-isolated), use the potential jumpers supplied with the front connector. This helps you to avoid having to terminate two wires to one terminal.

Proceed as follows:

1. Connect the 24 V DC supply voltage to terminals 19 and 20.
2. Insert the potential jumpers between terminals
 - 9 and 29 (L+)
 - 10 and 30 (M)
 - 19 and 39 (L+)
 - 20 and 40 (M)
3. Insert the jumpers between terminals 29 and 39, as well as 30 and 40.
4. Use the terminals 19 and 20 to distribute the potential to the next module.

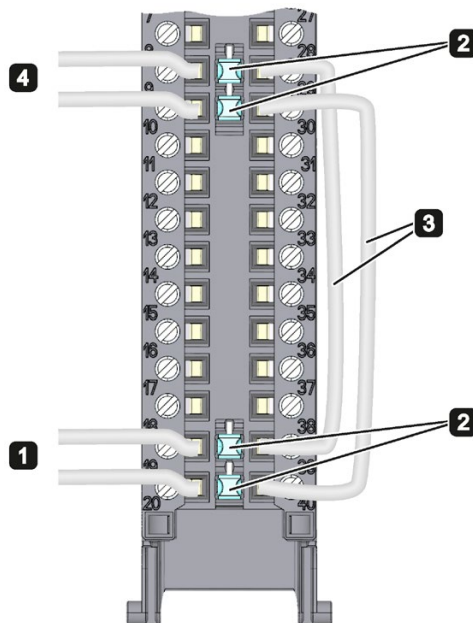

Figure 3-2 Using the potential jumpers

Note

Ensure that the maximum current load of 8 A per potential jumper is not exceeded.

Parameters/address space

4.1 Parameters

DQ 16x24VDC/0.5 HF parameters

When you assign the module parameters in STEP 7, you use various parameters to specify the module properties. The following table lists the configurable parameters. The effective range of the configurable parameters depends on the type of configuration. The following configurations are possible:

- Central operation with a S7-1500 CPU
- Distributed operation on PROFINET IO in an ET 200MP system
- Distributed operation on PROFIBUS DP in an ET 200MP system

For parameter assignment in the user program, the parameters are transferred to the module using the WRREC instruction (parameter assignment in RUN) and data sets; see section Parameter assignment (Page 36)

Table 4- 1 Configurable parameters and their defaults

Parameters	Range of values	Default setting	Parameter assignment in RUN	Scope with configuration software, e.g., STEP 7 (TIA Portal)	
				Integrated in the hardware catalog as of STEP 7, V13 SP1 or GSD file PROFIBUS DP	GSD file PROFIBUS DP
Diagnostics					
• No supply voltage L+	Yes/No	No	Yes	Channel*	Channel group (CH0 to CH7, CH8 to CH15)
• Short circuit to ground	Yes/No	No	Yes	Channel*	Channel group (CH0 to CH7, CH8 to CH15)
• Maintenance switching cycles	Yes/No	No	Yes	Channel (as of V15.0 with HSP0247)	---
• Switching cycle counter	Yes/No	No	Yes	Channel (as of V15.0 with HSP0247)	---
• Wire break	Yes/No	No	Yes	Channel*	Channel group (CH0 to CH7, CH8 to CH15)

4.1 Parameters

Parameters	Range of values	Default setting	Parameter assignment in RUN	Scope with configuration software, e.g., STEP 7 (TIA Portal)	
				Integrated in the hardware catalog as of STEP 7, V13 SP1 or GSD file PROFINET IO	GSD file PROFIBUS DP
Reaction to CPU STOP	<ul style="list-style-type: none"> • Turn off • Keep last value • Output substitute value 1 	Turn off	Yes	Channel	Channel
Switching cycle limits					
Switching cycle limit	0 ... 16777214	0	Yes	Channel (as of V15.0 with HSP0247)	---

* If you enable diagnostics for multiple channels, you will receive an alarm surge on failure of the supply voltage because each enabled channel will detect this fault. You can prevent this message burst by assigning the diagnostics function to one channel only.

4.2 Description of parameters

No supply voltage

Enabling of the diagnostics, for lacking or insufficient supply voltage L+.

Short circuit to ground

Enabling of the diagnostics if a short-circuit of the actuator supply (CHx) to ground occurs.

Maintenance switching cycles

You use this parameter to enable the maintenance interrupt "Limit value warning" when the switching cycle limit is violated.

You configure the limit with the parameter "Switching cycle limit" for each channel CHx.

Switching cycle counter

Channel-by-channel enable of switching cycle counter (Page 13).

Wire break

Enabling of the diagnostics if the line to the actuator is broken.

Reaction to CPU STOP

Determines the reaction of the output when the CPU goes into the STOP state or when the connection to the CPU is interrupted.

Switching cycle limit

Defines the limit channel-by-channel. If this value is exceeded, the "Limit value warning" maintenance interrupt is signaled.

Enter an integer value between 0 and 16777214. Refer to the data sheet of the connected actuator. We recommend that you do not enter this maximum value, but instead set it to 80% or 90%, for example, so that you have enough time to replace the actuator as a preventive measure.

4.3 Address space

The module can be configured differently in STEP 7; see following table. Depending on the configuration, additional/different addresses are assigned in the process image of the outputs/inputs.

Configuration options of DQ 16x24VDC/0.5A HF

You can configure the module with STEP 7 (TIA Portal) or with a GSD file.

When you configure the module by means of the GSD file, the configurations are available under different abbreviations/module names.

The following configurations are possible:

Table 4- 2 Configuration options

Configuration	Short designation/module name in the GSD file	Configuration software, e.g., STEP 7 (TIA Portal)	
		Integrated in the hardware catalog STEP 7 (TIA Portal) as of V13 SP1 with HSP 0143	GSD file in STEP 7 (TIA Portal) V12 or higher or STEP 7 V5.5 SP3 or higher
1 x 16-channel without value status	DQ 16x24VDC/0.5A HF	X	X
1 x 16-channel with value status	DQ 16x24VDC/0.5A HF QI	X	X
2 x 8-channel without value status	DQ 16x24VDC/0.5A HF S	X (PROFINET IO only)	X (PROFINET IO only)
2 x 8-channel with value status	DQ 16x24VDC/0.5A HF S QI	X (PROFINET IO only)	X (PROFINET IO only)
1 x 16-channel with value status for module-internal Shared Output with up to 4 submodules	DQ 16x24VDC/0.5A HF MSO	X (PROFINET IO only)	X (PROFINET IO only)

Note

Substitute value behavior in shared device operation with the following configuration (V1.0 only):

- **2 x 8-channel with / without value status**

If the system is in shared device mode and one of the IO controllers involved goes into STOP or fails due to a communication failure, for example, all submodules of the output module perform the configured substitute value reaction (e.g. shutdown).

This means that even when only one IO controller fails, the other IO controllers associated with the shared device no longer control the assigned submodule of the output module.

Value status (Quality Information, QI)

The value status is always activated for the following module names:

- DQ 16x24VDC/0.5A HF QI
- DQ 16x24VDC/0.5A HF S QI
- DQ 16x24VDC/0.5A HF MSO

An additional bit is assigned to each channel for the value status. The bit for the value status indicates if the output value specified by the user program is actually pending at the module terminal (0 = value is incorrect).

Note

The maintenance interrupt "Limit value warning" has no effect on the value status.

Address space for configuration as 16-channel DQ 16x24VDC/0.5A HF

The following figure shows the assignment of the address space for the configuration as a 16-channel module with value status. You can freely assign the start address for the module. The addresses of the channels are derived from the start address.

The letters "a to d" are printed onto the module. "QB a" stands for module start address output byte a.

Assignment in the process image of the outputs (PIO)

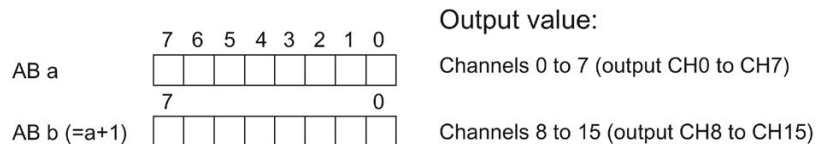

Assignment in the process image of the inputs (PII)



0 = Value output at the channel is faulty

Figure 4-1 Address space for configuration as 16-channel DQ 16x24VDC/0.5A HF with value status

4.3 Address space

Address space for configuration as 2 x 8-channel DQ 16x24VDC/0.5A HF S QI

For the configuration as a 2 x 8-channel module, the channels of the module are divided into multiple submodules. The submodules can be assigned to different IO controllers when the module is used in a shared device.

The number of IO controllers depends on the interface module used. Please observe the information in the manual for the particular interface module.

Contrary to the 1 x 16-channel module configuration, each of the two submodules has a freely assignable start address. The addresses for the respective value status of a submodule can also be assigned by the user.

Assignment in the process image of the outputs (PIO)

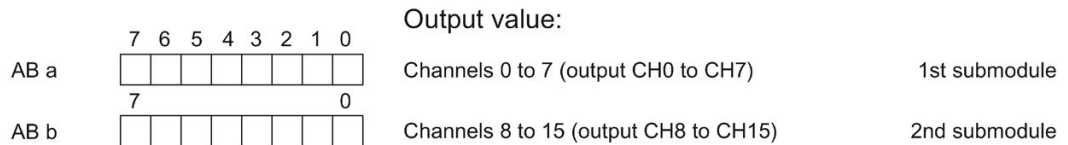

Assignment in the process image of the inputs (PII)

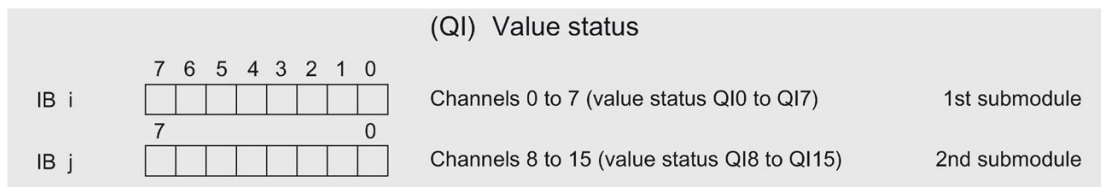

0 = Value output at the channel is faulty

Figure 4-2 Address space for configuration as 2 x 8-channel DQ 16x24VDC/0.5A HF S QI with value status

Address space for configuration as 1 x 16-channel DQ 16x24VDC/0.5A HF MSO

For the configuration as a 1 x 16-channel module (module-internal shared output, MSO), channels 0 to 15 of the module are copied to multiple submodules. Channels 0 to 15 are then available with identical values in various submodules. These submodules can be assigned to up to four IO controllers when the module is used in a shared device:

- The IO controller to which submodule 1 is assigned has write access to outputs 0 to 15.
- The IO controllers to which submodule 2, 3, or 4 is assigned have read access to outputs 0 to 15.

The number of IO controllers depends on the interface module used. Observe the information in the manual for the particular interface module.

Value status (Quality Information, QI)

The meaning of the value status depends on the submodule on which it occurs.

For the first submodule (=basic submodule), the value status 0 indicates that the value is incorrect or that the IO controller of the basic submodule is in STOP state.

For 2nd to 4th submodule (=MSO submodule), the value status 0 indicates that the value is incorrect or one of the following errors has occurred:

- The basic submodule is not yet configured (not ready).
- The connection between the IO controller and the basic submodule has been interrupted.
- The IO controller of the basic submodule is in STOP or POWER OFF state.

The following figure shows the assignment of the address space for submodules 1 and 2 and the value status.

Assignment in the process image of the outputs (PIO) for 1st submodule

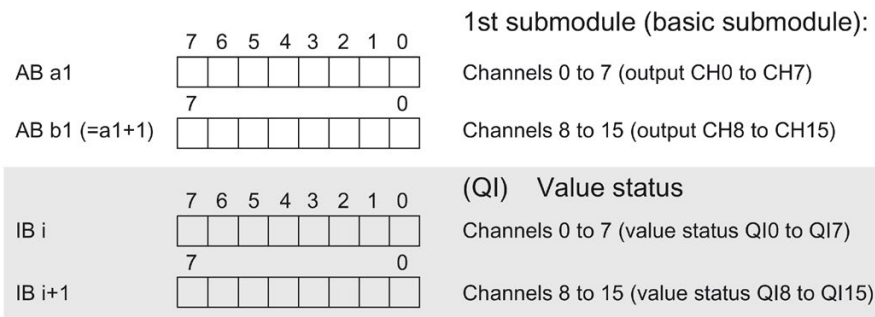

Assignment in the process image of the inputs (PII) for 2nd submodule

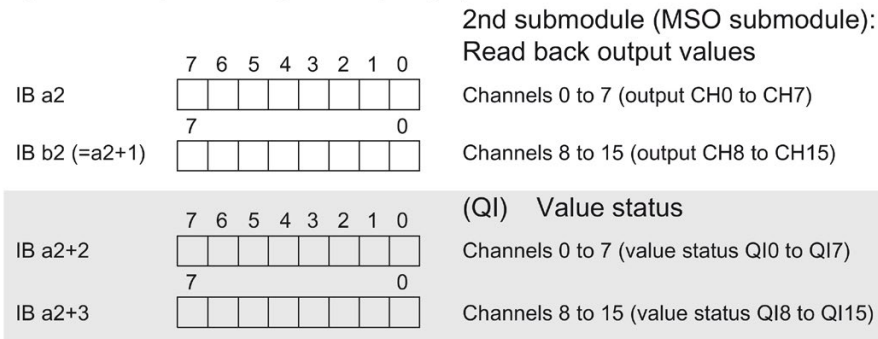

0 = Value output at the channel is faulty

Figure 4-3 Address space for configuration as 1 x 16-channel DQ 16x24VDC/0.5A HF S MSO with value status

4.3 Address space

The following figure shows the assignment of the address space with submodules 3 and 4 and the value status.

Assignment in the process image of the inputs (PII) for 3rd and 4th submodule

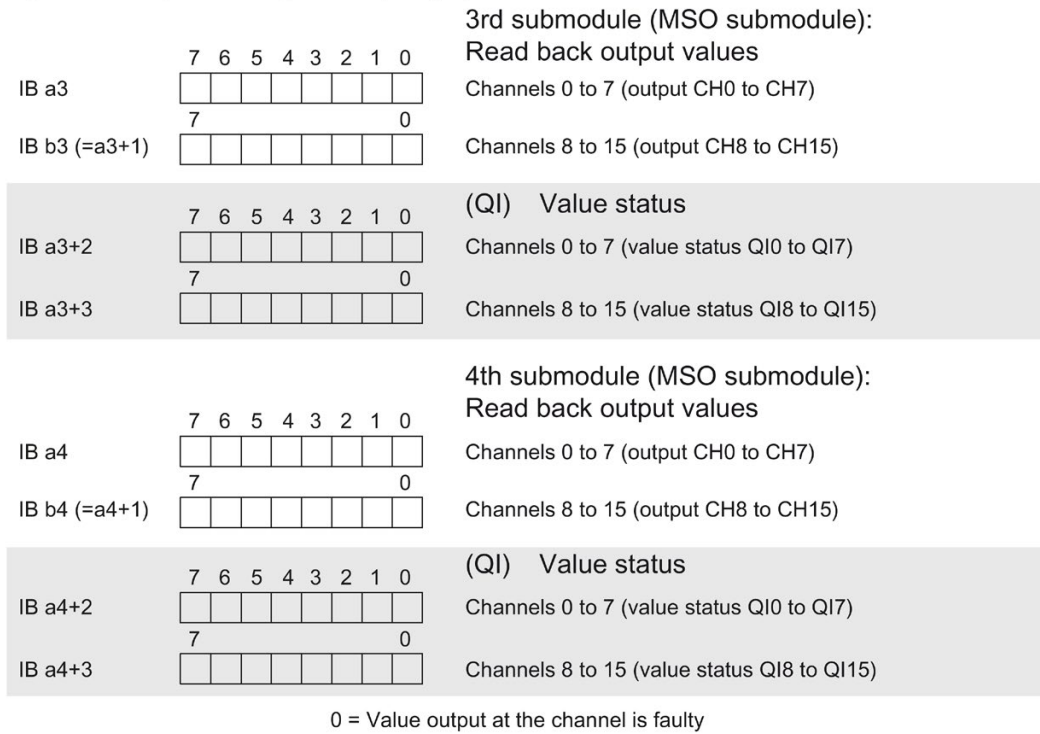

0 = Value output at the channel is faulty

Figure 4-4 Address space for configuration as 1 x 16-channel DQ 16x24VDC/0.5A HF S MSO with value status

Reference

You can find information on the Shared Input/Output (MSI/MSO) function in the section Module-Internal Shared Input/Output (MSI/MSO) of the PROFINET with STEP 7 V13 (<https://support.industry.siemens.com/cs/ww/en/view/49948856>) function manual.

Interrupts/diagnostics alarms

5.1 Status and error displays

LED displays

The following figure shows the LED displays (status and error displays) of module.

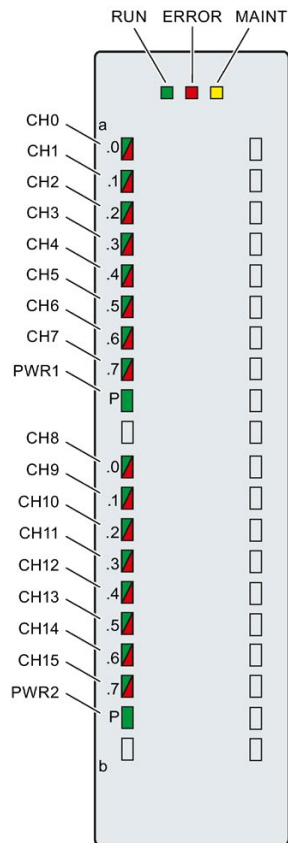











Figure 5-1 LED displays of the DQ 16x24VDC/0.5A HF module

Meaning of the LED displays

The tables below explain the meaning of the status and error displays. Remedial measures for diagnostic alarms can be found in section Diagnostic alarms (Page 28).



RUN and ERROR LED

Table 5- 1 Status and error displays RUN and ERROR

LED		Meaning	Solution
RUN	ERROR		
 Off	 Off	Voltage missing or too low at backplane bus	<ul style="list-style-type: none"> Switch on the CPU and/or the system power supply modules. Verify that the U connectors are inserted. Check to see if too many modules are inserted.
 Flashes	 Off	The module starts and flashes until the valid parameter assignment is set.	---
 On	 Off	Module is configured	---
 On	 Flashes	Indicates module errors (at least one error at one channel, e.g., short-circuit to ground).	Evaluate the diagnostics data and eliminate the error (e.g., check the cables).
 Flashes	 Flashes	Hardware defective	Replace the module.



LED MAINT

Table 5- 2 MAINT status display

LED MAINT	Meaning	Solution
 Off	0 = No maintenance interrupt is pending.	---
 On	1 = The maintenance interrupt "Limit value warning" is pending.	---

PWR1 and PWR2 LED

Table 5- 3 PWR1 and PWR2 status indication

LED PWRx	Meaning	Solution
 Off	Supply voltage L+ too low or missing	Check the L+ supply voltage.
 On	Supply voltage L+ is present and OK	---

LED CHx

Table 5- 4 CHx status display

LED CHx	Meaning	Solution
□ Off	0 = Status of the output signal	---
■ On	1 = Status of the output signal	---
■ On	<ul style="list-style-type: none"> • Wire break or short-circuit to ground • Supply voltage L+ missing or too low 	<ul style="list-style-type: none"> • Correct the process wiring • Check the supply voltage.

5.2 Interrupts

The digital output module DQ 16x24VDC/0.5A HF supports diagnostic interrupts and maintenance interrupts.

You can find detailed information on the event in the error organization block with the "RALRM" instruction (read additional interrupt info) and in the STEP 7 online help.

Diagnostic interrupt

The module generates a diagnostic interrupt at the following events:

- No supply voltage L+
- Short circuit to ground
- Wire break
- Parameter assignment error

Maintenance interrupt

The module generates a maintenance interrupt at the following events:

- Limit value warning

5.3 Diagnostics alarms

Diagnostics alarms

A diagnostics alarm is generated and the ERROR LED flashes for each diagnostics event on the module. You can read the diagnostics alarms, for example, in the diagnostics buffer of the CPU. You can evaluate the error codes with the user program.

If the module is operated distributed with PROFIBUS DP in an ET 200MP system, you have the option to read out diagnostics data with the instruction RDREC or RD_REC using data record 0 and 1. The structure of the data records is available on the Internet in the "Manual for interface module IM 155-5 DP ST (6ES7155-5BA00-0AB0)".

Table 5- 5 Diagnostics alarms, their meaning and corrective measures

Diagnostics alarm	Error code	Meaning	Corrective measures
Short circuit to ground	1 _H	Short-circuit or overload at the channel	Check the wiring/actuator. Check the ambient temperature.
Wire break*	6 _H	Actuator circuit impedance too high.	Use different actuator type or wire differently, e.g. use lines with bigger cross-section
		Wire break between the module and actuator	Connect the cable
		Channel not connected (open)	<ul style="list-style-type: none"> Disable diagnostics Connect a resistor to the actuator contacts in the load resistance range
Parameter assignment error	10 _H	<ul style="list-style-type: none"> The module cannot evaluate parameters for the channel. Incorrect parameter assignment 	Correct the parameter assignment
Load voltage missing	11 _H	Supply voltage L+ of the module is missing	Connect supply voltage L+ to module/channel
Limit value warning	17 _H	The configured limit for switching cycles has been exceeded.	<ul style="list-style-type: none"> Replace actuator as a precautionary measure Reset counter with DS131

* Wire break is also reported for short-circuit of actuator supply to L+. This can lead to inappropriate diagnostics for redundant load control.

Technical specifications

Technical specifications of the DQ 16x24VDC/0.5A HF

The following table shows the technical specifications as of 06/2018. You will find a data sheet including daily updated technical specifications on the Internet (<https://support.industry.siemens.com/cs/ww/en/pv/6ES7522-1BH01-0AB0/td?dl=en>).

Article number	6ES7522-1BH01-0AB0
General information	
Product type designation	DQ 16x24VDC/0.5A HF
HW functional status	FS02
Firmware version	V1.1.0
<ul style="list-style-type: none"> FW update possible 	Yes
Product function	
<ul style="list-style-type: none"> I&M data 	Yes; I&M0 to I&M3
Engineering with	
<ul style="list-style-type: none"> STEP 7 TIA Portal configurable/integrated as of version 	V13 SP1 / -
<ul style="list-style-type: none"> PROFIBUS as of GSD version/GSD revision 	V1.0 / V5.1
<ul style="list-style-type: none"> PROFINET as of GSD version/GSD revision 	V2.3 / -
Operating mode	
<ul style="list-style-type: none"> DQ 	Yes
<ul style="list-style-type: none"> DQ with energy-saving function 	No
<ul style="list-style-type: none"> PWM 	No
<ul style="list-style-type: none"> Cam control (switching at comparison values) 	No
<ul style="list-style-type: none"> Oversampling 	No
<ul style="list-style-type: none"> MSO 	Yes
<ul style="list-style-type: none"> Integrated operating cycle counter 	Yes
Supply voltage	
Rated value (DC)	24 V
permissible range, lower limit (DC)	20.4 V
permissible range, upper limit (DC)	28.8 V
Reverse polarity protection	Yes; through internal protection with 7 A per group

Article number	6ES7522-1BH01-0AB0
Input current	
Current consumption, max.	30 mA
Output voltage	
Rated value (DC)	24 V
Power	
Power available from the backplane bus	1.1 W
Power loss	
Power loss, typ.	2 W
Digital outputs	
Type of digital output	Transistor
Number of digital outputs	16
Current-sourcing	Yes
Short-circuit protection	Yes; Clocked electronically
• Response threshold, typ.	1 A
Limitation of inductive shutdown voltage to	L+ (-53 V)
Controlling a digital input	Yes
Switching capacity of the outputs	
• with resistive load, max.	0.5 A
• on lamp load, max.	5 W
Load resistance range	
• lower limit	48 Ω
• upper limit	12 kΩ
Output voltage	
• for signal "1", min.	L+ (-0.8 V)
Output current	
• for signal "1" rated value	0.5 A
• for signal "1" permissible range, max.	0.5 A
• for signal "0" residual current, max.	0.5 mA
Output delay with resistive load	
• "0" to "1", max.	100 μs
• "1" to "0", max.	500 μs
Parallel switching of two outputs	
• for logic links	Yes
• for uprating	No
• for redundant control of a load	Yes

Article number	6ES7522-1BH01-0AB0
Switching frequency	
<ul style="list-style-type: none"> with resistive load, max. with inductive load, max. on lamp load, max. 	<p>100 Hz</p> <p>0.5 Hz; According to IEC 60947-5-1, DC-13</p> <p>10 Hz</p>
Total current of the outputs	
<ul style="list-style-type: none"> Current per channel, max. Current per group, max. Current per module, max. 	<p>0.5 A; see additional description in the manual</p> <p>4 A; see additional description in the manual</p> <p>8 A; see additional description in the manual</p>
Cable length	
<ul style="list-style-type: none"> shielded, max. unshielded, max. 	<p>1 000 m</p> <p>600 m</p>
Isochronous mode	
Isochronous operation (application synchronized up to terminal)	Yes
Execution and activation time (TCO), min.	70 μ s
Bus cycle time (TDP), min.	250 μ s
Interrupts/diagnostics/status information	
Diagnostics function	Yes
Substitute values connectable	Yes
Alarms	
<ul style="list-style-type: none"> Diagnostic alarm 	Yes
Diagnostic messages	
<ul style="list-style-type: none"> Monitoring the supply voltage Wire-break Short-circuit Group error 	<p>Yes</p> <p>Yes</p> <p>Yes</p> <p>Yes</p>
Diagnostics indication LED	
<ul style="list-style-type: none"> RUN LED ERROR LED MAINT LED Monitoring of the supply voltage (PWR-LED) Channel status display for channel diagnostics for module diagnostics 	<p>Yes; Green LED</p> <p>Yes; Red LED</p> <p>Yes; yellow LED</p> <p>Yes; Green LED</p> <p>Yes; Green LED</p> <p>Yes; Red LED</p> <p>Yes; Red LED</p>

Article number	6ES7522-1BH01-0AB0
Potential separation	
Potential separation channels	
<ul style="list-style-type: none"> • between the channels 	No
<ul style="list-style-type: none"> • between the channels, in groups of 	8
<ul style="list-style-type: none"> • between the channels and backplane bus 	Yes
Isolation	
Isolation tested with	707 V DC (type test)
Standards, approvals, certificates	
Suitable for safety-related tripping of standard modules	Yes; From FS02
Highest safety class achievable for safety-related tripping of standard modules	
<ul style="list-style-type: none"> • Performance level according to ISO 13849-1 	PL d
<ul style="list-style-type: none"> • Category according to ISO 13849-1 	Cat. 3
<ul style="list-style-type: none"> • SILCL according to IEC 62061 	SILCL 2
Ambient conditions	
Ambient temperature during operation	
<ul style="list-style-type: none"> • horizontal installation, min. 	0 °C
<ul style="list-style-type: none"> • horizontal installation, max. 	60 °C
<ul style="list-style-type: none"> • vertical installation, min. 	0 °C
<ul style="list-style-type: none"> • vertical installation, max. 	60 °C
Decentralized operation	
Prioritized startup	Yes
Dimensions	
Width	35 mm
Height	147 mm
Depth	129 mm
Weights	
Weight, approx.	230 g

Residual current at signal state "0":

Note

Due to the Diagnostics: Wire break function, there is a low level of residual current in the "0" signal state at the output, which may cause the display diodes to flicker.

This residual current does not depend on the setting for the wire break diagnostics parameter.

Power reduction (derating) to aggregate current of outputs (per group)

The following graphs show the loading capacity of the digital outputs in relation to the mounting position of the S71500 / Distributed I/O System ET 200MP automation system and the ambient temperature.

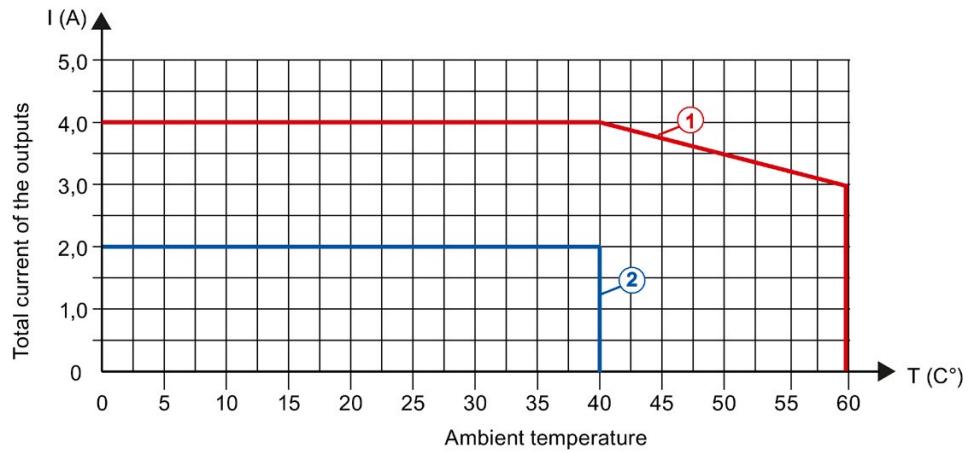

- ① Horizontal mounting of the system
- ② Vertical mounting of the system

Figure 6-1 Details on aggregate current of outputs (per group)

Dimensional drawing

A.1 Dimensional drawing

The dimensional drawing of the module on the mounting rail, as well as a dimensional drawing with open front cover, are provided in this appendix. Always observe the specified dimensions for installations in cabinets, control rooms, etc.

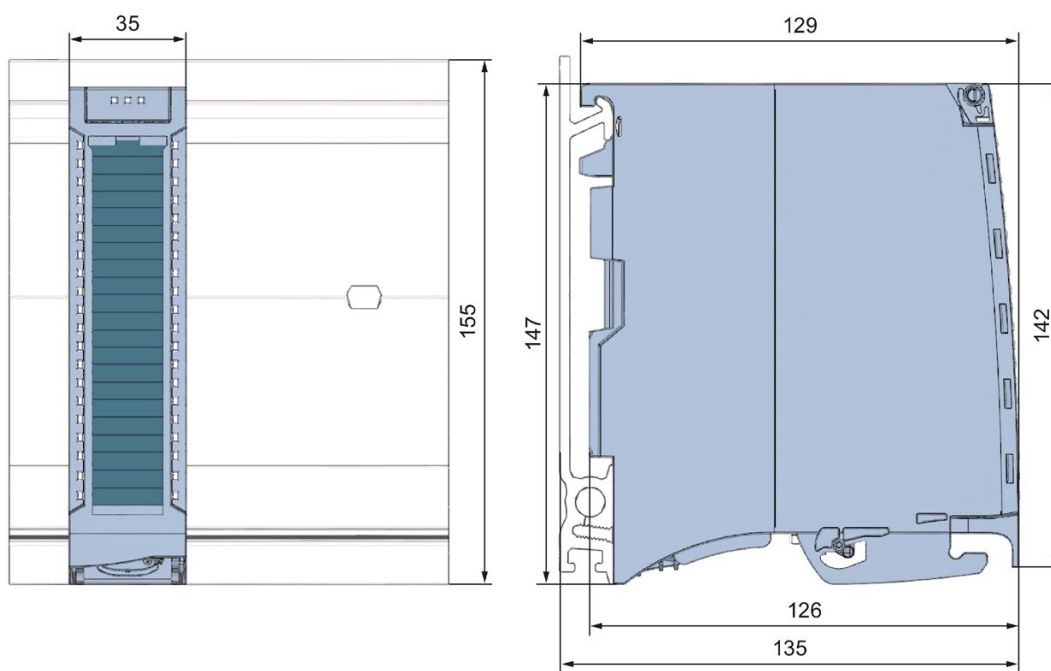

Figure A-1 Dimension drawing of the DQ 16x24VDC/0.5A HF module

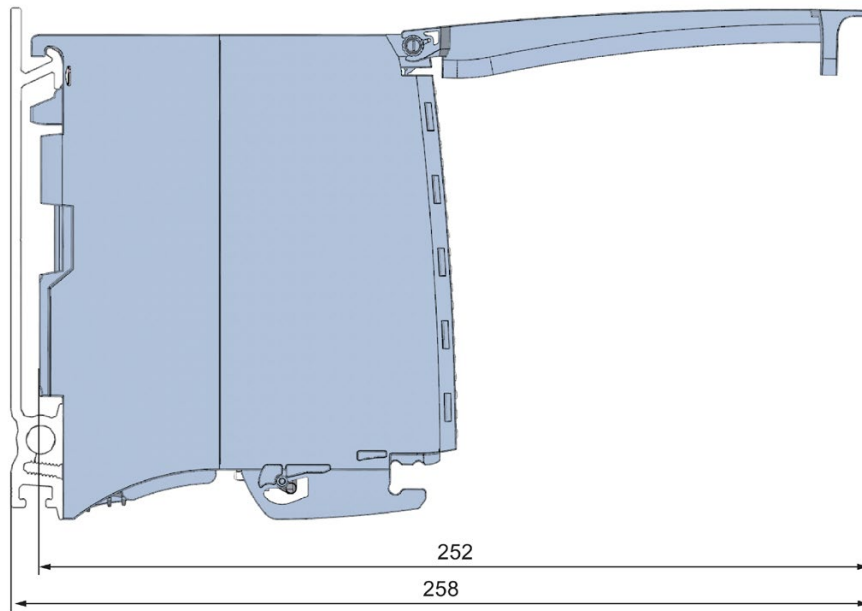

Figure A-2 Dimension drawing of the DQ 16x24VDC/0.5A HF module, side view with open front cover

Parameter data records

B.1 Parameter assignment

The data records of the module have an identical structure, regardless of whether you configure the module with PROFIBUS DP or PROFINET IO.

Dependencies for configuration with GSD file

When a GSD file is used to configure a module, dependencies can arise when "assigning the parameters".

There are no dependencies for this module. You can assign the individual parameters in any combination.

Parameter assignment in the user program

You have the option to reconfigure the modules in RUN (e.g. the response of selected channels to the CPU-STOP state can be changed in RUN without having an effect on the other channels)

Parameter assignment in RUN

The WRREC instruction is used to transfer the parameters to the module using data sets 64 to 79. The parameters set in STEP 7 do not change in the CPU, which means the parameters set in STEP 7 are still valid after a restart.

The parameters are only checked for plausibility by the module after the transfer.

Output parameter STATUS

The module ignores errors that occurred during the transfer of parameters with the WRREC instruction and continues operation with the previous parameter assignment. However, a corresponding error code is written to the STATUS output parameter.

The description of the WRREC instruction and the error codes is available in the STEP 7 online help.

Assignment of data record and channel

For the configuration as a 1 x 16-channel module, the parameters are located in data sets 64 to 79 and are assigned as follows:

- Data record 64 for channel 0
- Data record 65 for channel 1
- ...
- Data set 78 for channel 14
- Data set 79 for channel 15

For the configuration as a 2 x 8-channel module, the module has 2 submodules with eight channels each. The parameters for the channels are located in data records 64 to 71 and are assigned as follows:

- Data records 64 to 71 for channels 0 to 7 (submodule 1)
- Data records 64 to 71 for channels 8 to 15 (submodule 2)

Address the respective submodule for data record transfer.

B.2 Structure of parameter data sets DS 64 - 79

Structure of data sets 64 to 79

The figure below shows the structure of data set 64 for channel 0 as an example. The structure is identical for channels 1 to 15. The values in byte 0 and byte 1 are fixed and may not be changed.

Enable a parameter by setting the corresponding bit to "1".

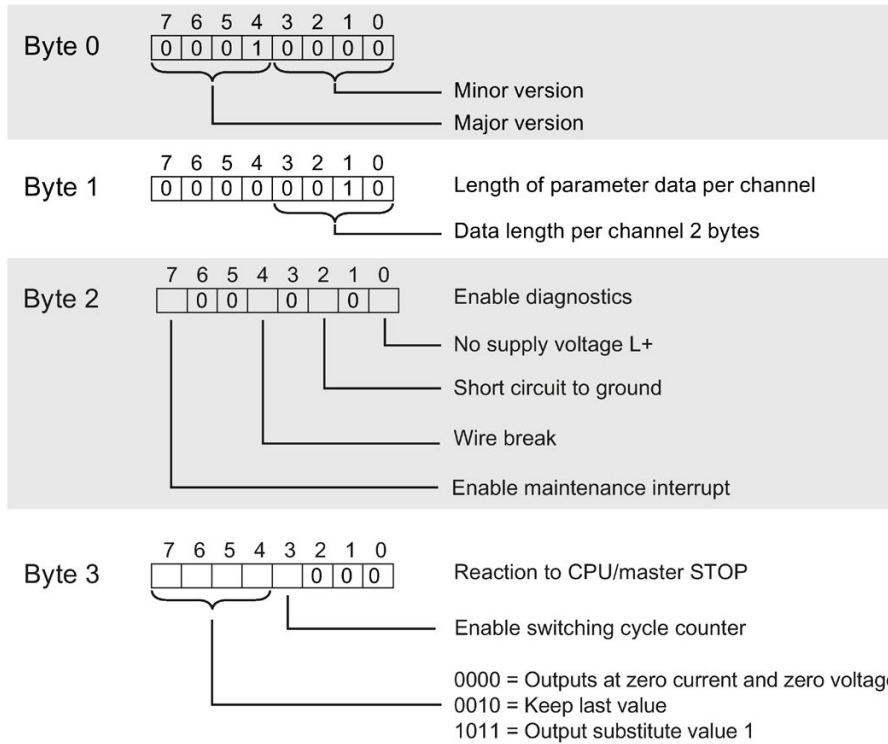

Figure B-1 Structure of data record 64: Bytes 0 to 3

B.3 Structure of data set DS 129

Structure of data set 129

You can read the current states of the switching cycle counters with data set 129. The counter status is supplied for each channel in UDINT format. The length of the data set results from the number of channels in the selected submodule.

The following figure shows you the structure of data set 129 for 16 channels.

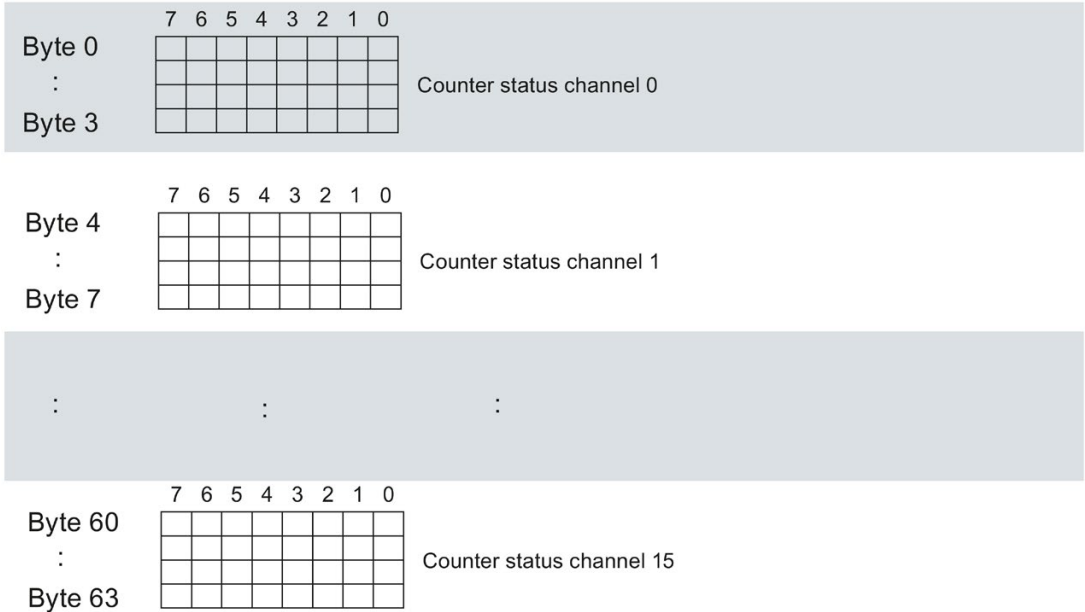

Figure B-2 Structure of data set 129: Byte 0 to 63

B.3 Structure of data set DS 129

The following figure shows you the structure of data set 129 for 2 submodules with 8 channels each.

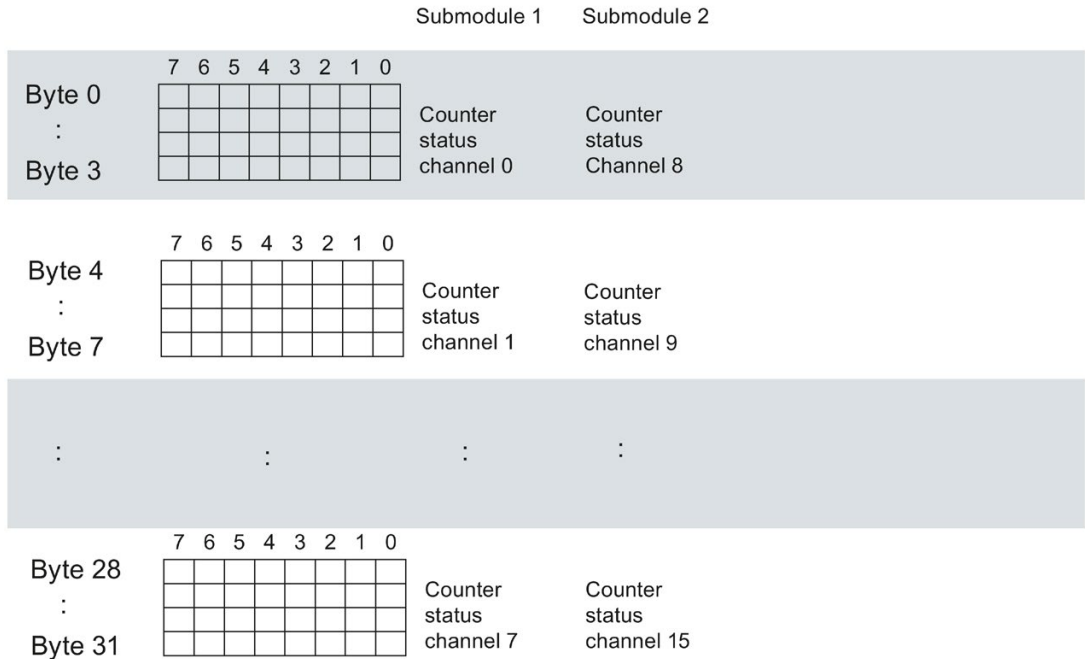

Figure B-3 Structure of data set 129: Byte 0 to 31

B.4 Structure of data set DS 130

Structure of data set 130

The limits of the switching cycle counters are read out with data set 130. The set value is supplied for each channel in UDINT format. The length of the data set results from the number of channels in the selected submodule.

The following figure shows you the structure of data set 130 for 16 channels.

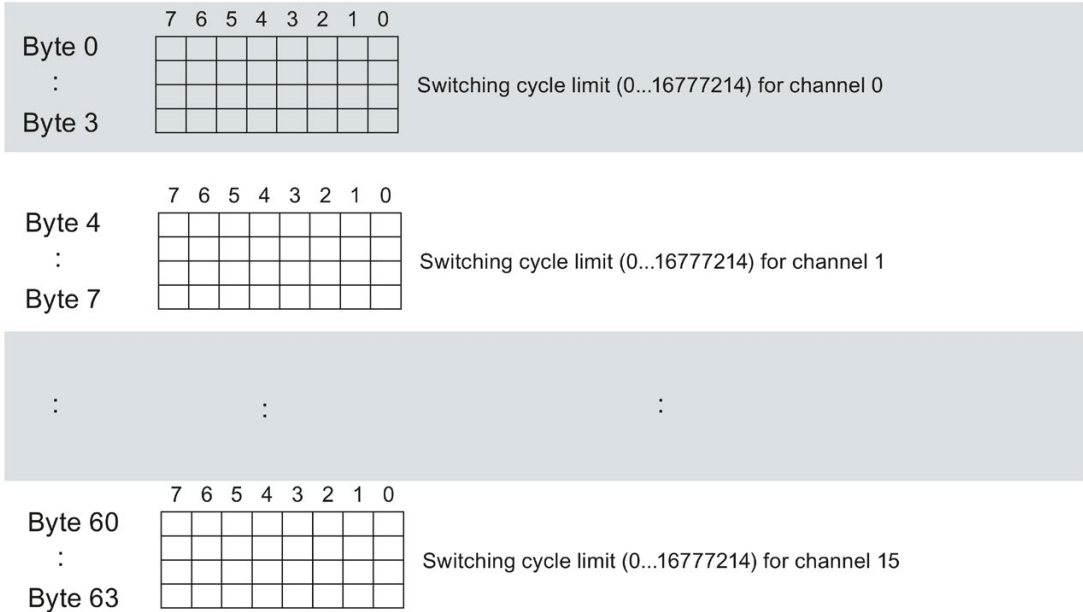

Figure B-4 Structure of data set 130: Byte 0 to 63

The following figure shows you the structure of data set 130 for 2 submodules with 8 channels each.

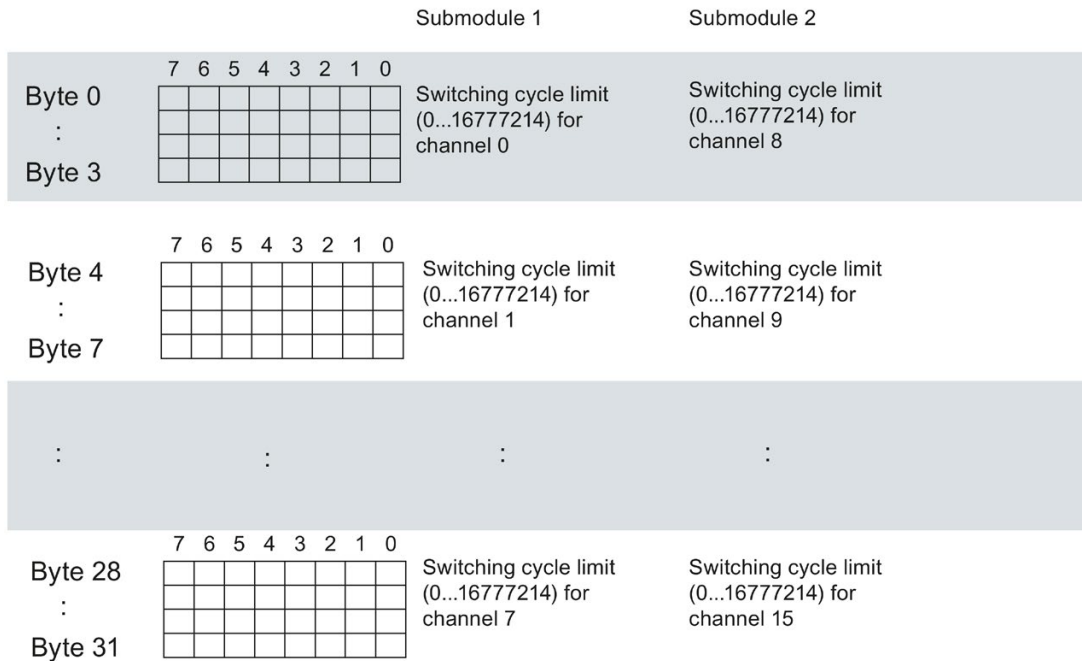

Figure B-5 Structure of data set 130: Byte 0 to 31

B.5 Structure of data set DS 131

Structure of data set 131

The following figure shows you the structure of data set 131.
 Enable a parameter by setting the corresponding bit to "1".

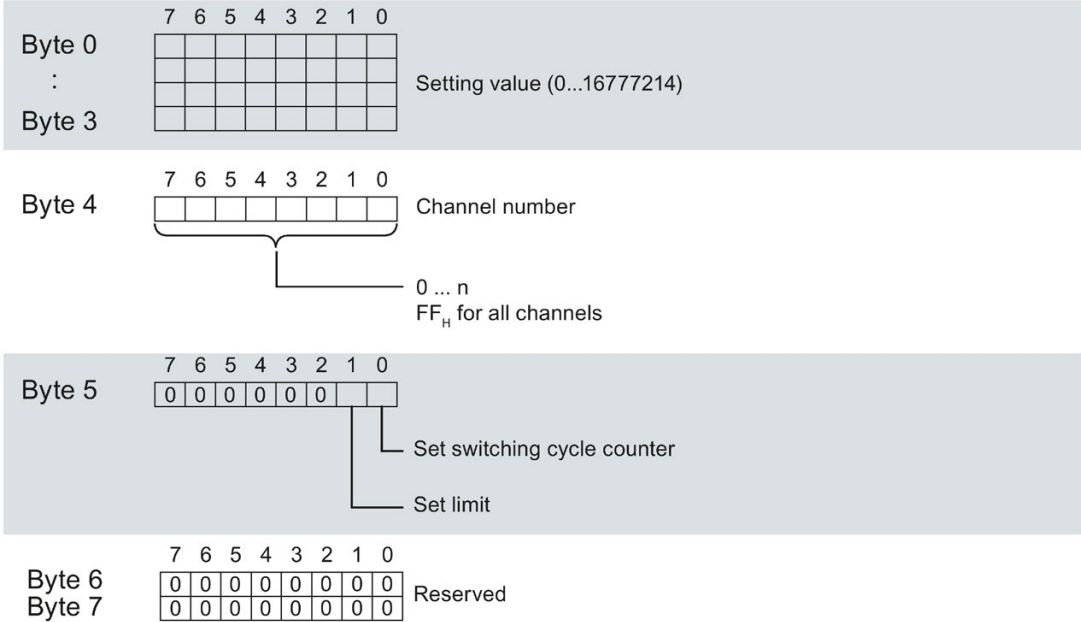

Figure B-6 Structure of data set 131: Bytes 0 to 7