

SIEMENS

SIMATIC

Industrial PC SIMATIC IPC477E

Operating Instructions

Preface

Overview

1

Safety instructions

2

Mounting and connecting the device

3

Commissioning the device

4

Operating the device and device functions

5

Expanding the device and assigning device parameters

6

Maintaining and servicing your device

7

Technical information

8

Technical support

A

Markings and symbols

B



List of abbreviations

C

Legal information

Warning notice system

This manual contains notices you have to observe in order to ensure your personal safety, as well as to prevent damage to property. The notices referring to your personal safety are highlighted in the manual by a safety alert symbol, notices referring only to property damage have no safety alert symbol. These notices shown below are graded according to the degree of danger.

 DANGER
indicates that death or severe personal injury will result if proper precautions are not taken.
 WARNING
indicates that death or severe personal injury may result if proper precautions are not taken.
 CAUTION
indicates that minor personal injury can result if proper precautions are not taken.
NOTICE
indicates that property damage can result if proper precautions are not taken.

If more than one degree of danger is present, the warning notice representing the highest degree of danger will be used. A notice warning of injury to persons with a safety alert symbol may also include a warning relating to property damage.

Qualified Personnel

The product/system described in this documentation may be operated only by **personnel qualified** for the specific task in accordance with the relevant documentation, in particular its warning notices and safety instructions. Qualified personnel are those who, based on their training and experience, are capable of identifying risks and avoiding potential hazards when working with these products/systems.

Proper use of Siemens products

Note the following:

 WARNING
Siemens products may only be used for the applications described in the catalog and in the relevant technical documentation. If products and components from other manufacturers are used, these must be recommended or approved by Siemens. Proper transport, storage, installation, assembly, commissioning, operation and maintenance are required to ensure that the products operate safely and without any problems. The permissible ambient conditions must be complied with. The information in the relevant documentation must be observed.

Trademarks

All names identified by ® are registered trademarks of Siemens AG. The remaining trademarks in this publication may be trademarks whose use by third parties for their own purposes could violate the rights of the owner.

Disclaimer of Liability

We have reviewed the contents of this publication to ensure consistency with the hardware and software described. Since variance cannot be precluded entirely, we cannot guarantee full consistency. However, the information in this publication is reviewed regularly and any necessary corrections are included in subsequent editions.

Preface

Purpose of the Operating Instructions

These operating instructions contain all the information you need for commissioning and operating the SIMATIC IPC477E.

It is intended both for programming and testing personnel who commission the device and connect it with other units (automation systems, programming devices), as well as for service and maintenance personnel who install add-ons or carry out fault/error analyses.

Basic knowledge required

A solid background in personal computers and Microsoft operating systems is required to understand this manual. General knowledge in the field automation control engineering is recommended.

Scope of the operating instructions

These operating instructions apply to "SIMATIC IPC477E" industrial PCs with article numbers 6AV7241... (built-in unit).

Scope of this documentation

The documentation for the IPC includes the following:

- Product information, e.g. "Important notes on your device"
- Quick Install Guide SIMATIC IPC477E
- SIMATIC IPC477E Operating Instructions

The documentation is supplied with the IPC in multiple languages as PDF on the USB stick supplied in the documentation package.

Conventions

In these operating instructions, "device" is used as the standard term for "SIMATIC IPC477E" (built-in unit).

In these operating instructions, the terms "Windows Embedded Standard 7 P" and "Windows Embedded Standard 7 E" are also abbreviated with the term "Windows Embedded Standard". "Windows 7" is used as an abbreviation for "Windows 7 Ultimate".

A touch device generally refers to a device with a capacitive multi-touch screen or a resistive single-touch screen. Touch screen is the general term for a resistive single-touch screen or a capacitive multi-touch screen.

Note

A note is important information about the product, handling the product or a reference to specific sections of the documentation that require special consideration.

History

The following editions of these operating instructions have already been published:

Edition	Comments
10/2016	First edition
12/2016	Amendment to the multi-touch devices
10/2017	Addition of the 24" multi-touch device Amendment regarding Windows 10

Table of contents

	Preface	3
1	Overview.....	9
1.1	Product description	9
1.2	Layout of the devices	12
1.2.1	Devices with resistive single-touch screens	12
1.2.2	Devices with capacitive multi-touch screens	13
1.2.3	Device with PCIe slot	14
1.2.4	Interfaces and operator controls for devices with 24 V DC power supply	15
1.2.5	Interfaces and operator controls for devices with 100-240 V AC power supply	16
1.3	Accessories.....	17
2	Safety instructions.....	19
2.1	General safety instructions	19
2.2	Industrial Security	21
2.3	Notes on usage.....	22
3	Mounting and connecting the device	25
3.1	Preparing for mounting	25
3.1.1	Checking the delivery package	25
3.1.2	Device identification data	27
3.1.3	Permitted mounting positions	29
3.1.4	Preparing the mounting cutout.....	31
3.2	Mounting the device	33
3.2.1	Installation guidelines.....	33
3.2.2	Mounting the device with mounting clips (single-touch device).....	35
3.2.3	Mounting the device with mounting clips (multi-touch device).....	39
3.2.4	Fastening a device using a VESA adapter	42
3.3	Connecting the device	44
3.3.1	Notes on connecting	44
3.3.2	Power supply	45
3.3.2.1	Connecting the protective earth	45
3.3.2.2	Connect 100-240 VAC power supply.....	47
3.3.2.3	Connecting the terminal.....	50
3.3.2.4	Connecting the 24 V DC power supply.....	51
3.3.3	Connecting peripheral equipment.....	53
3.3.4	Connecting the device to networks.....	54
3.3.5	Securing cables on the device	55

4	Commissioning the device	57
4.1	Notes on commissioning and operation.....	57
4.2	Initial commissioning.....	58
4.3	Windows Action Center.....	60
5	Operating the device and device functions	61
5.1	Operator input options	61
5.2	Operating a device with resistive single-touch screen.....	62
5.3	Operating a device with capacitive multi-touch screen.....	63
5.4	IPC Driver and Tools.....	65
5.5	Extended device functions	66
5.5.1	Monitoring functions.....	66
5.5.1.1	Overview of the monitoring functions.....	66
5.5.1.2	Temperature monitoring/display	67
5.5.1.3	Watchdog (WD).....	68
5.5.1.4	Battery monitoring	69
5.5.1.5	Mass storage monitoring.....	69
5.5.2	Unified Write Filter (UWF).....	69
5.5.3	Enhanced Write Filter (EWF)	70
5.5.4	File Based Write Filter (FBWF)	73
5.5.5	Buffer memory NVRAM	74
5.5.6	Active Management Technology (AMT)	75
5.5.7	Trusted Platform Modul (TPM).....	77
6	Expanding the device and assigning device parameters.....	79
6.1	Open the device.....	79
6.2	Installing and removing a memory module	80
6.3	Install and remove PCIe card (devices with PCIe card)	82
6.4	Installing and removing a CFast card (external slot)	84
6.5	Assigning CPU power consumption parameters	86
7	Maintaining and servicing your device.....	87
7.1	Maintenance.....	87
7.2	Repair information.....	87
7.3	Cleaning the Device Front	90
7.4	Installing and removing hardware	91
7.4.1	Replacing the backup battery	91
7.4.2	Replacing the SSD.....	93
7.4.3	Replacing HDD	95

7.5	Installing the software	97
7.5.1	Reinstalling the operating system	97
7.5.1.1	General installation procedure	97
7.5.1.2	Restoring the delivery state	99
7.5.1.3	Windows 7 / Windows 10	100
7.5.1.4	Windows Embedded Standard	103
7.5.2	Partitioning data media	105
7.5.2.1	Partitioning in Windows Embedded Standard 7	105
7.5.2.2	Setting up the partitions under Windows 7 Ultimate and Windows 10	106
7.5.2.3	Adapting partitions in Windows 7 Ultimate and Windows Embedded Standard 7	107
7.5.3	Installing drivers and software	108
7.5.4	Update installation	109
7.5.4.1	Updating the operating system	109
7.5.4.2	Installing or updating application programs and drivers	109
7.5.5	Backing up data	109
7.6	Recycling and disposal	110
8	Technical information	111
8.1	Certificates and approvals	111
8.2	Directives and declarations	113
8.2.1	Electromagnetic compatibility	113
8.2.2	ESD guideline	113
8.3	Dimension drawings	116
8.3.1	Dimension drawing of 15" device with capacitive multi-touch screen	116
8.3.2	Dimension drawing of 19" device with capacitive multi-touch screen	118
8.3.3	Dimension drawing of 22" device with capacitive multi-touch screen	120
8.3.4	Dimension drawing of 24" device with capacitive multi-touch screen	122
8.3.5	Dimension drawing of 15" device with resistive single-touch screen	124
8.3.6	Dimension drawing of 19" device with resistive single-touch screen	126
8.3.7	Dimension drawing of 22" device with resistive single-touch screen	128
8.4	Technical specifications	130
8.4.1	General technical specifications	130
8.4.2	Environmental conditions	134
8.4.3	Power requirements of the components	136
8.4.4	Integrated DC power supply	136
8.4.5	AC voltage supply	137
8.5	Hardware descriptions	138
8.5.1	External ports	138
8.5.1.1	Serial interface	138
8.5.1.2	CFast	139
8.5.1.3	DisplayPort	140
8.5.1.4	Ethernet	141
8.5.1.5	USB 3.0 port	141
8.5.1.6	USB 2.0	142
8.5.2	Internal ports	143
8.5.2.1	PCIe card	143
8.5.3	System resources	145
8.5.3.1	Currently allocated system resources	145
8.5.3.2	Assignment of system resources	145

8.5.4	I/O Address Areas	147
8.5.4.1	Overview of the internal module registers	147
8.5.4.2	Watchdog enable register / 066h select register (read/write, address 062h)	147
8.5.4.3	Watchdog trigger register (read only, address 066h)	148
8.5.4.4	Output register user LED L1/L2/L3 (read/write, address 404Eh)	148
8.5.4.5	Battery status register (read-only, address 404Dh)	149
8.5.4.6	NVRAM address register	149
8.6	BIOS description	150
8.6.1	Overview	150
8.6.2	Opening the BIOS selection menu.....	151
8.6.3	Structure of the BIOS Setup menu	153
8.6.4	Exit menu	155
8.6.5	BIOS update.....	156
8.6.6	Alarm, error and system messages	157
8.7	Active Management Technology (AMT)	158
8.7.1	Introduction	158
8.7.2	Overview of AMT.....	159
8.7.3	Enabling Intel® AMT / basic configuration.....	159
8.7.4	Resetting the Intel® AMT to the default settings and disabling AMT	161
8.7.5	Determining the network address	162
8.7.6	Forcing user consent	162
8.8	Scope of functions in Windows Embedded Standard 7.....	163
A	Technical support.....	165
A.1	Service and support	165
A.2	Problem solving.....	166
A.3	Notes on the use of third-party modules	167
B	Markings and symbols	169
B.1	Overview	169
B.2	Safety	169
B.3	Operator controls	169
B.4	Certificates, approvals and markings.....	170
B.5	Interfaces	171
C	List of abbreviations	173
	Glossary	179
	Index	187

Overview

1.1 Product description

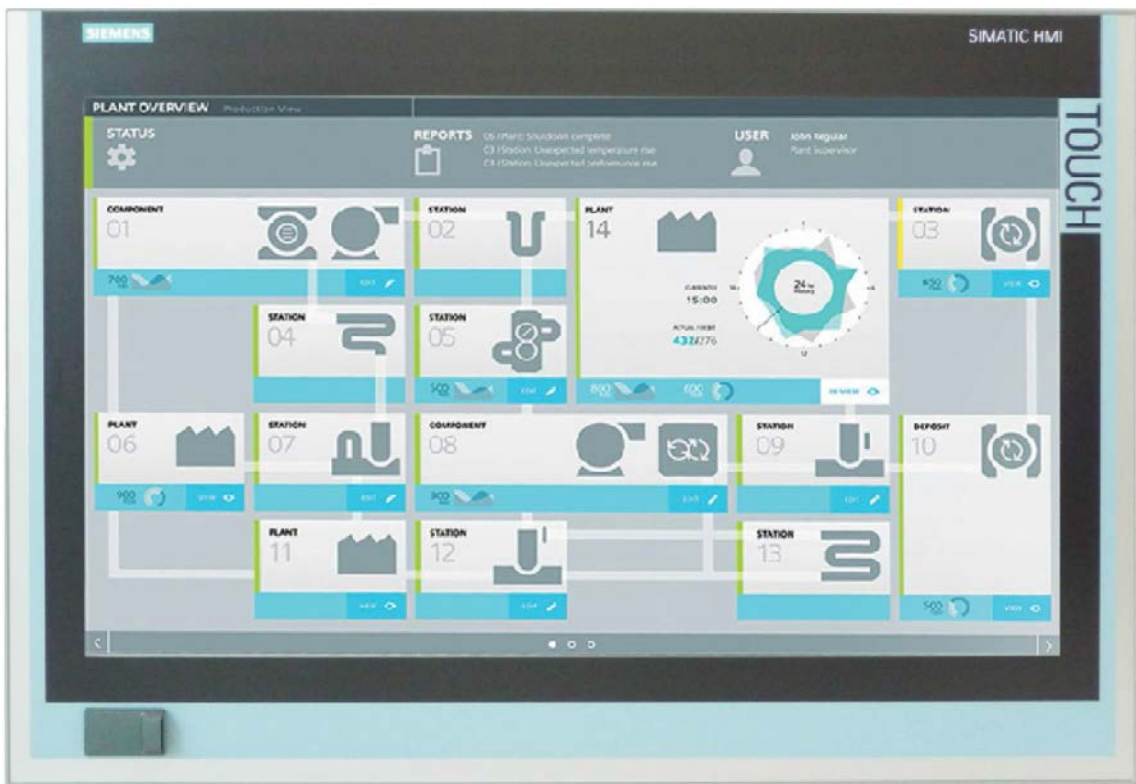

Figure 1-1 Device with resistive single-touch screen



Figure 1-2 Device with capacitive multi-touch screen

Features

The SIMATIC IPC477E provides high-level industrial functionality.

- Compact design
- Maintenance-free operation
- Rugged

Device variants

The delivery note contains information on the precise scope of functions and product package for your device.

The SIMATIC IPC477E is available in the following device variants, which differ in regard to the display size, operating method and optional expansions:

Devices with resistive single-touch screens

- Display:
 - 15" display, resolution: 1280 x 800 pixels
 - 19" display, resolution: 1366 x 768 pixels
 - 22" display, resolution: 1920 x 1080 pixels
- with PCIe slot

Devices with capacitive multi-touch screens

- Display:
 - 15.6" display, resolution: 1366 x 768 pixels
 - 19" display, resolution: 1366 x 768 pixels
 - 22" display, resolution: 1920 x 1080 pixels
 - 24" display, resolution: 1920 x 1080 pixels
- With PCIe slot

1.2 Layout of the devices

1.2.1 Devices with resistive single-touch screens

Front and side views

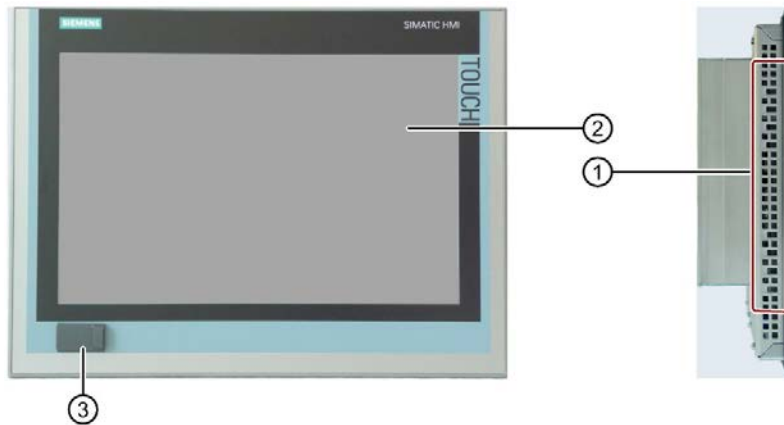

- ① Cutouts for mounting clips
- ② Display with touch screen
- ③ USB socket

Bottom view

The bottom view shows a device with 24 V DC power supply and PCIe extension.



- ① Cutouts for mounting clips

Rear view

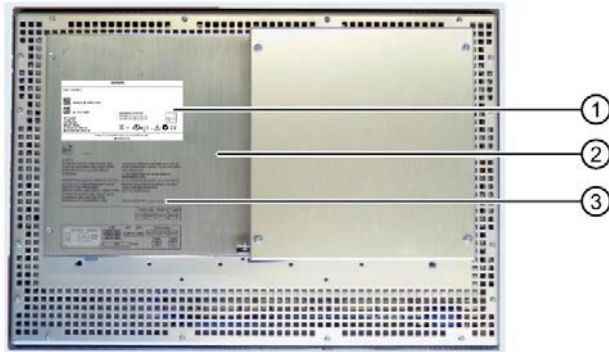

- ① Rating plate
- ② Rear panel / rear panel of expansion
- ③ Labeling for the interface arrangement

1.2.2 Devices with capacitive multi-touch screens

The following figures show the 19" device without PCIe card as an example.

Front and side views



- ① Cutouts for mounting clips
- ② Display with touch screen

Bottom view



- ① Cutouts for mounting clips

Rear view



- ① Rating plate
- ② Rear panel
- ③ Labeling for the interfaces

1.2.3 Device with PCIe slot

The following figures show the 15" device with resistive single-touch screen and PCIe extension as an example.

Rear view and side view

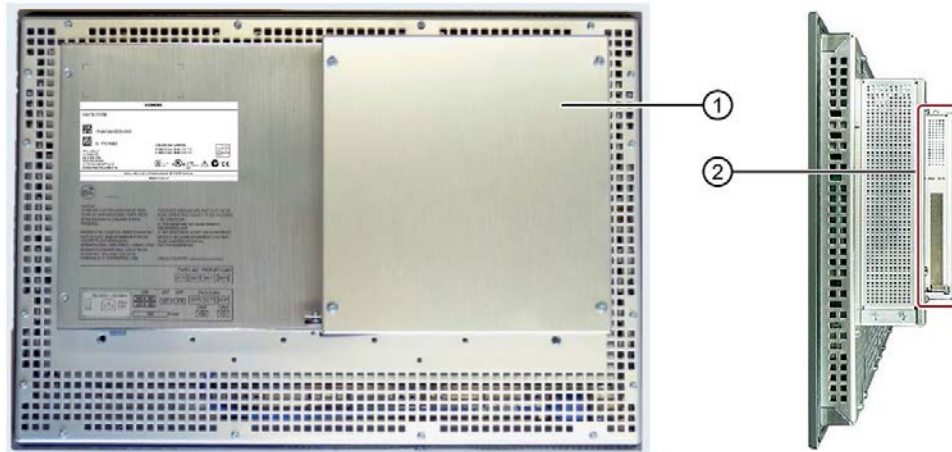

- ① Rear panel
- ② PCIe slot

Bottom view



1.2.4 Interfaces and operator controls for devices with 24 V DC power supply

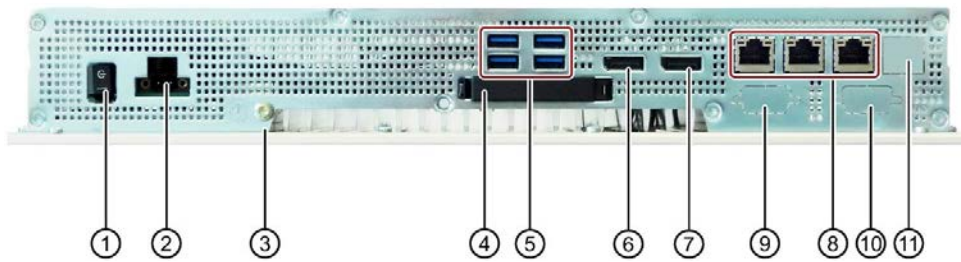

- | | | |
|---|---------------------------------|-----------------------------------|
| ① | On/Off switch | |
| ② | 24 V DC power supply | |
| ③ | Protective conductor connection | |
| ④ | Slot for external CFast card | With cover |
| ⑤ | 4 x USB port | USB 3.0 high speed/high current |
| ⑥ | Display port | |
| ⑦ | Display port | |
| ⑧ | 3 x Ethernet port | 3 x RJ45 (10/100/1000 Mbps) |
| ⑨ | COM1 port (optional) | Serial interface, 9-pin D-Sub pin |
| ⑩ | COM2 port (optional) | Serial interface, 9-pin D-Sub pin |
| ⑪ | Reserved | |

1.2.5 Interfaces and operator controls for devices with 100-240 V AC power supply

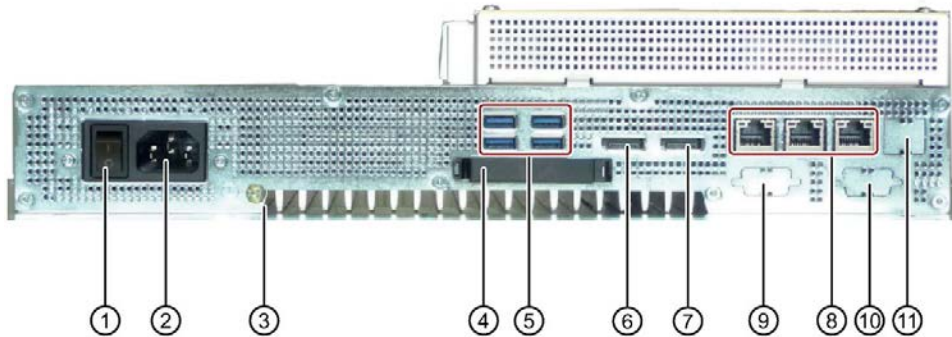

- ① On/Off switch
 - ② 100-240 V AC power supply
 - ③ Protective conductor connection
 - ④ Slot for external CFast card
 - ⑤ 4 x USB port
 - ⑥ Display port
 - ⑦ Display port
 - ⑧ 3 x Ethernet port
 - ⑨ COM1 port (optional)
 - ⑩ COM2 port (optional)
 - ⑪ Reserved
- With cover
USB 3.0 high speed/high current
- 3 x RJ45 (10/100/1000 Mbps)
Serial interface, 9-pin D-Sub pin
- Serial interface, 9-pin D-Sub pin

1.3 Accessories

Accessories are available for your device. These are not included in the product package. You can find Information on available accessories on the Internet at:

Industry Mall (<https://mall.industry.siemens.com>)

Expansion components and accessories (http://www.automation.siemens.com/mcms/pc-based-automation/en/industrial-pc/expansion_components_accessories)

SIMATIC IPC CFast cards

- 2 GB optional or
- 4 GB optional or
- 8 GB optional or
- 16 GB optional or
- 30 GB optional



Memory modules

- SO-DIMM module 4096 MB DDR4-SDRAM
- SO-DIMM module 8192 MB DDR4-SDRAM
- SO-DIMM module 16384 MB DDR4-SDRAM
- SO-DIMM module 8192 MB DDR4-SDRAM ECC
- SO-DIMM module 16384 MB DDR4-SDRAM ECC

Other accessories

- Touch stylus, only for devices with resistive single-touch screens

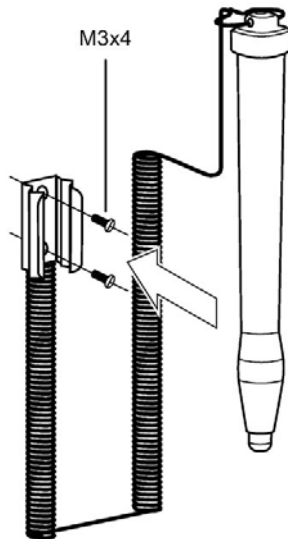

- Mounting bracket, only for devices with resistive single-touch screens

If there are higher requirements for the front seal, fasten the device with mounting brackets in a control cabinet.



Safety instructions

2.1 General safety instructions

 WARNING
Life-threatening voltages are present with an open control cabinet
When you install the device in a control cabinet, some areas or components in the open control cabinet may be carrying life-threatening voltages.
If you touch these areas or components, you may be killed by electric shock.
Switch off the power supply to the cabinet before opening it.

System expansions

NOTICE
Damage through system expansions
Device and system expansions may be faulty and can affect the entire machine or plant.
The installation of expansions can damage the device, machine or plant. Device and system expansions may violate safety rules and regulations regarding radio interference suppression. If you install or exchange system expansions and damage your device, the warranty becomes void.
Note the following for system expansions:
<ul style="list-style-type: none">• Only install system expansion devices designed for this device. Contact your technical support team or where you purchased your PC to find out which system expansion devices may safely be installed.• Read the information on electromagnetic compatibility (Page 113).

NOTICE
"Open Type" UL508
Note that the built-in unit is classified as "Open Type" for use in the area of Industrial Control Equipment (UL508). The installation of the built-in unit in an enclosure conforming to UL508 is a mandatory requirement for approval and operation in accordance with UL508.

Battery and rechargeable battery

 WARNING
Risk of explosion and release of harmful substances Improper handling of lithium batteries can result in an explosion of the batteries. Explosion of the batteries and the released pollutants can cause severe physical injury. Worn batteries jeopardize the function of the device. Note the following when handling lithium batteries: <ul style="list-style-type: none">• Replace spent batteries promptly. You can find information on installing and removing the backup battery in the Operating Instructions.• Replace the lithium battery only with an identical battery or types recommended by the manufacturer.• Do not throw lithium batteries into fire, do not solder on the cell body, do not recharge, do not open, do not short-circuit, do not reverse polarity, do not heat above 100°C and protect from direct sunlight, moisture and condensation.

Strong high-frequency radiation

NOTICE
Observe immunity to RF radiation The device has an increased immunity to RF radiation according to the specifications on electromagnetic compatibility in the technical specifications. Radiation exposure in excess of the specified immunity limits can impair device functions, result in malfunctions and therefore injuries or damages. Read the information on immunity to RF radiation in the technical specifications.

ESD Guideline



Electrostatic sensitive devices can be labeled with an appropriate symbol.

NOTICE
Electrostatic sensitive devices (ESD) When you touch electrostatic sensitive components, you can destroy them through voltages that are far below the human perception threshold. If you work with components that can be destroyed by electrostatic discharge, observe the ESD Guideline (Page 113).

2.2 Industrial Security

Industrial Security

Siemens provides products and solutions with industrial security functions that support the secure operation of plants, systems, machines and networks.

In order to protect plants, systems, machines and networks against cyber threats, it is necessary to implement – and continuously maintain – a holistic, state-of-the-art industrial security concept. Siemens' products and solutions only form one element of such a concept.

Customer is responsible to prevent unauthorized access to its plants, systems, machines and networks. Systems, machines and components should only be connected to the enterprise network or the internet if and to the extent necessary and with appropriate security measures (e.g. use of firewalls and network segmentation) in place.

Additionally, Siemens' guidance on appropriate security measures should be taken into account. For more information about industrial security, please visit (<https://www.siemens.com/industrialsecurity>).

Siemens' products and solutions undergo continuous development to make them more secure. Siemens strongly recommends to apply product updates as soon as available and to always use the latest product versions. Use of product versions that are no longer supported, and failure to apply latest updates might increase customer's exposure to cyber threats.

To stay informed about product updates, subscribe to the Siemens Industrial Security RSS Feed under (<https://www.siemens.com/industrialsecurity>).

Disclaimer for third-party software updates

This product includes third-party software. Siemens AG only provides a warranty for updates/patches of the third-party software, if these have been distributed as part of a Siemens software update service contract or officially released by Siemens AG. Otherwise, updates/patches are undertaken at your own risk. You can find more information about our Software Update Service offer on the Internet at Software Update Service (<http://www.automation.siemens.com/mcms/automation-software/en/software-update-service>).

Notes on protecting administrator accounts

A user with administrator privileges has extensive access and manipulation options in the system.

Therefore, ensure there are adequate safeguards for protecting the administrator accounts to prevent unauthorized changes. To do this, use secure passwords and a standard user account for normal operation. Other measures, such as the use of security policies, should be applied as needed.

2.3 Notes on usage

 **WARNING**

Risks associated with the unprotected machine or plant

According to the results of a risk analysis, certain hazard potentials associated with the unprotected machine exist. These hazards could lead to personal injury.

Avoid such hazards by taking the following precautions in accordance with the risk analysis:

- Installation of additional safety equipment on the machine or plant. In particular, the programming, parameter assignment and wiring of the inserted I/O modules must be executed in accordance with the safety performance identified by the necessary risk analysis (SIL, PL or Cat.).
- Use as intended must be validated for the device by means of a function test on the plant. These tests help you to identify programming, parameter assignment and wiring errors.
- Documentation of the test results that you can enter in the relevant safety verification documents, if necessary.

Environment

NOTICE

Ambient conditions and chemical resistance

Unsuitable environmental conditions have a negative impact on device operation. Chemical substances such as cleaners or fuels may alter the color, shape and structure of the device surface, for example, the front panel.

The device may be damaged, possibly resulting in malfunctions.

For this reason, please observe the following precautions:

- Always operate the device in closed rooms. All warranties shall be void in the case of noncompliance.
- Operate the device only in accordance with the ambient conditions specified in the technical specifications.
- Protect the device against dust, moisture and heat.
- Do not expose the device to direct sunlight or to other strong sources of light.
- Without additional safety measures, such as a supply of clean air, the device may not be used in locations with harsh operating conditions caused by acidic vapors or gases.
- Observe the permitted mounting positions of the device.
- Do not obstruct the venting slots of the device.
- Always use suitable cleaning agents. Read the information about Chemical resistance of the HMI devices and industrial PCs (<http://support.automation.siemens.com/WW/view/en/39718396>) on the Internet.

Note

Use in an industrial environment without additional protective measures

The device has been designed for use in a normal industrial environment in accordance with IEC 60721-3-3 (pollutant class 3C2 for chemical influences, 3S2 for dust without sand).

Mounting and connecting the device

3.1 Preparing for mounting

3.1.1 Checking the delivery package

Procedure

1. When accepting a delivery, please check the packaging for visible transport damage.
2. If any transport damage is present at the time of delivery, lodge a complaint at the shipping company in charge. Have the shipper confirm the transport damage immediately.
3. Unpack the device at its installation location.
4. Keep the original packaging in case you have to transport the unit again.

Note

Damage to the device during transport and storage

If a device is transported or stored without packaging, shocks, vibrations, pressure and moisture may impact the unprotected unit. Damaged packaging indicates that ambient conditions have already had a massive impact on the device and it may be damaged.

This may cause the device, machine or plant to malfunction.

- Keep the original packaging.
 - Pack the device in the original packaging for transportation and storage.
-

5. Check the contents of the packaging and any accessories you may have ordered for completeness and damage.

3.1 Preparing for mounting

- Please inform the delivery service immediately if the package contents are incomplete or damaged or do not correspond with your order. Fax the enclosed form "SIMATIC IPC/PG Quality Control Report".

 WARNING
Electric shock and fire hazard due to damaged device A damaged device can be under hazardous voltage and trigger a fire in the machine or plant. A damaged device has unpredictable properties and states. Death or serious injury could occur. Make sure that the damaged device is not inadvertently installed and put into operation. Label the damaged device and keep it locked away. Send off the device for immediate repair.

NOTICE
Damage from condensation If the device is subjected to low temperatures or extreme fluctuations in temperature during transportation, as is the case in cold weather, for example, moisture can build up on or inside the device (condensation). Moisture causes a short circuit in electrical circuits and damages the device. In order to prevent damage to the device, proceed as follows: <ul style="list-style-type: none">• Store the device in a dry place.• Bring the device to room temperature before starting it up.• Do not expose the device to direct heat radiation from a heating device.• If condensation develops, wait approximately 12 hours or until the device is completely dry before switching it on.

- Please keep the enclosed documentation in a safe place. It belongs to the device. You need the documentation when you commission the device for the first time.
- Write down the identification data of the device.

3.1.2 Device identification data

Unpacking the device

The device can be clearly identified with the help of this identification data in case of repairs or theft.

Enter the identification data in the table below:

Identification data	Source	Value
Serial number	Rating plate	S VP ...
Article number of the device	Rating plate	6AV7241 (SIMATIC IPC477E)
Microsoft Windows Product Key Certificate of Authenticity (COA)	Back of the device	Only devices with preinstalled Windows operating systems have the COA label
Ethernet address 1	BIOS setup, "Advanced" menu	
Ethernet address 2		
Ethernet address 3		

Example of rating plate on SIMATIC IPC477E

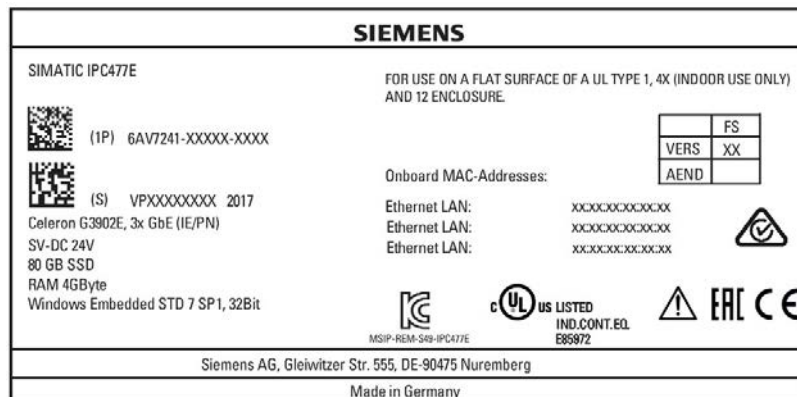

COA label

Microsoft Windows "Product Key" from the "Certificate of Authenticity" (COA):

3.1 Preparing for mounting

The COA label is present only when Windows Embedded Standard 7 or Windows 7 is installed.

- COA label of a device with the Windows Embedded Standard 7 operating system

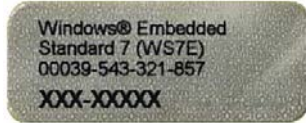

- COA label of a device with Windows 7 operating system



- COA label of a device with Windows 10 operating system



The Windows 10 COA label has an additional security feature which conceals part of the product key.

The scratch-off panel consists of a small transparent label with a silver-colored scratch coating, which was applied to conceal part of the 25-character product key. This scratch-off panel is designed to protect the product key from being obtained and used by unauthorized third parties.

You usually do not need this product key for commissioning because a valid product key has already been integrated into the pre-installed operating system.

3.1.3 Permitted mounting positions

The mounting positions described below are permitted for the device. For information on the maximum permissible ambient temperatures during operation, refer to section "Environmental conditions (Page 134)".

<p>! CAUTION</p> <p>Danger from high enclosure temperature if device is touched</p> <p>Self-heating can cause the temperature of the device to exceed 70 °C during operation at an ambient temperature > 40 °C.</p> <p>If you want to operate the built-in device at an ambient temperature > 40 °C, you will have to install it in a Restricted Access Location (RAL) such as a lockable control cabinet.</p>
--

Note

Operation with hard disk

Operation with hard disk is only permitted in standard mounting position "Vertical installation in horizontal format".

- Standard mounting position: Vertical installation in horizontal format

In this mounting position, the device enclosure satisfies the requirements of a fire protection enclosure.

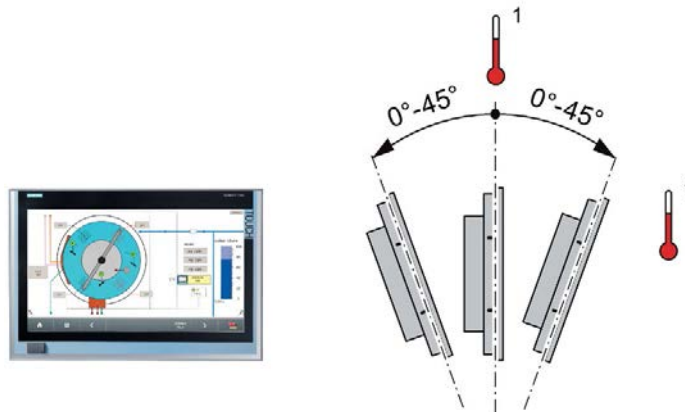

¹ For temperature specifications, see section "Environmental conditions (Page 134)".

- Inclined installation in horizontal format with a vertical inclination of maximum $\pm 45^\circ$
In an inclined mounting position, the device enclosure satisfies the requirements of a fire protection enclosure.
- Upright mounting in vertical format (only permitted for the built-in unit)

! CAUTION

Fire protection enclosure requirement not fulfilled

In the "Upright mounting in vertical position" mounting position, the device enclosure does not satisfy the requirement of a fire protection enclosure.

If you want to operate the built-in device in this mounting position, check if the built-in unit has to meet the requirement for a fire protection enclosure in the desired operating area. If in doubt, install the built-in device in an enclosure that is compliant with the requirements of sections 4.6 and 4.7.3 of the IEC/UL/EN/DIN-EN 60950-1 standard.

Display rotated 90° vertical from the standard position. The power supply is located at the top.

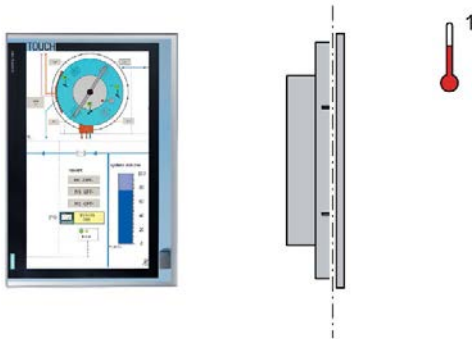

¹ For temperature specifications, see section "Environmental conditions (Page 134)".

3.1.4 Preparing the mounting cutout

Note**Stability of the mounting cutout**

The material in the area of the mounting cutout must provide sufficient strength to guarantee the enduring and safe mounting of the HMI device.

The force of the clamps or operation of the device must not lead to deformation of the material in order to achieve the degrees of protection described below.

Note

Read the information in the section "Installation guidelines (Page 33)".

Requirements for complying with degree of protection

The degree of protection of the HMI device can only be guaranteed if the following requirements are met:

- Material thickness at the mounting cutout with IP65 degree of protection or Enclosure Type 4X / 12 (indoor use only): 2 mm to 6 mm
- Permitted deviation from plane at the mounting cutout: ≤ 0.5 mm
This condition must be fulfilled for the mounted HMI device.
- Permissible surface roughness in the area of the mounting seal: ≤ 120 μm (R_z 120)

Dimensions of the mounting cutout

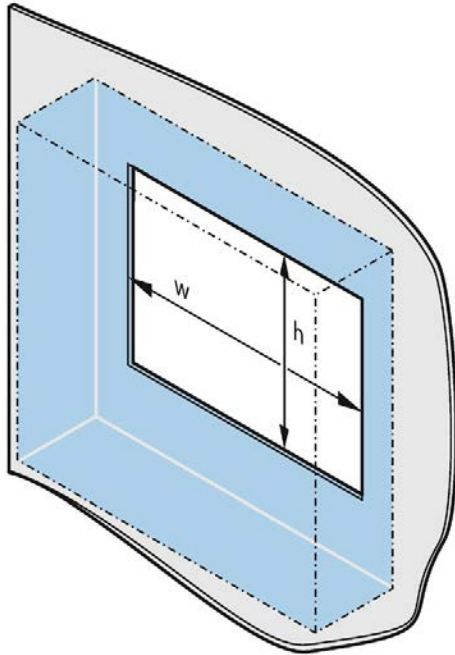

Mounting cutout of touch devices

Mounting cutout	Single-touch device ²			Multi-touch device ³			
	15"	19"	22"	15"	19"	22"	24"
Width w ¹	396 ⁺¹ mm	465 ⁺¹ mm	542 ⁺¹ mm	382 ⁺¹ mm	448 ⁺¹ mm	513 ⁺¹ mm	569 ⁺¹ mm
Height h ¹	291 ⁺¹ mm	319 ⁺¹ mm	362 ⁺¹ mm	241 ⁺¹ mm	278 ⁺¹ mm	315 ⁺¹ mm	347 ⁺¹ mm

¹ Width and height must be interchanged for mounting in vertical format.

² Device with resistive single-touch screen

³ Device with capacitive multi-touch screen

Installation depth

Information on the overall depth is available in the section "Dimension drawings (Page 116)".

3.2 Mounting the device

3.2.1 Installation guidelines

 WARNING
Danger, high voltage A high voltage may be present in the control cabinet and could cause a dangerous electric shock. It may result in death or serious physical injury. Isolate the power supply to the control cabinet before opening it. Ensure that the power to the control cabinet cannot be turned on accidentally.

 WARNING
Risk of fire If you install the device in an unapproved mounting position or if you do not observe the ambient conditions, the device can overheat. Overheating can cause a fire. Proper functioning of the device is no longer guaranteed. Before you install the device, note the following general installation information.

 WARNING
Requirements for a fire protection enclosure according to EN 60950-1 only for standard mounting position In the standard mounting position and in the inclined position in horizontal format with vertical inclination of max. $\pm 45^\circ$, the device meets the requirements for fire protection enclosures in accordance with EN 60950-1. It can therefore be installed without an additional fire protection cover. For information on the mounting positions, refer to section "Permitted mounting positions (Page 29)".

- Install the device only in one of the permitted mounting positions.
- For installation in control cabinets, note the SIMATIC setup guidelines as well as the relevant DIN/VDE requirements or the country-specific regulations.
- Ensure that the device is classified as "Open Type" when using it in the area of Industrial Control Equipment (UL508). A UL508 conform enclosure is therefore a mandatory requirement for approval or operation according to UL508.
- Provide adequate volume in the control cabinet for air circulation and heat transport. Keep at least 5 cm distance between the device and control cabinet.
- The ventilation slots of the device may not be covered or obstructed.

3.2 Mounting the device

- Ensure there is enough clearance in the control cabinet to allow the backplane cover to be removed.
- Equip the control cabinet with struts for stabilizing the mounting cut-out. Install struts where necessary.

See also

Dimension drawings (Page 116)

Technical specifications (Page 130)

3.2.2 Mounting the device with mounting clips (single-touch device)

Types of mounting clips and mounting brackets

You can mount the device as follows:

- With 12 mounting clips, steel (included in the product package)



- With 6 mounting clips (available as accessory for devices with resistive single-touch screen)

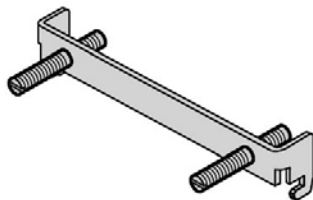

Positions of the mounting clips

To achieve the degree of protection for the device, the positions for the mounting clips shown below must be adhered to.

The positions of the mounting clips are marked by stamps on the cutouts. Fit the mounting clips in all the stamped cutouts.

Requirement

- All packaging components and protective films have been removed from the device.
- To install the device, you need the mounting clips from the accessory kit.
- The mounting seal on the front of the device is not managed.

Procedure

Note

If the mounting seal is damaged or protrudes from the device, the guaranteed degree of protection is not ensured.

It is prohibited from mounting the device if the mounting seal is damaged.

3.2 Mounting the device

1. Working from the front, insert the device into the mounting cut-out. Secure the device to prevent it from falling out.
2. Insert a mounting clip into the cutout provided on the device.
3. Tighten the threaded pin to secure the mounting clip. The maximum torque when tightening the threaded pins of the mounting clips is 0.5 Nm.
4. Repeat steps 2 and 3 for all mounting clips.

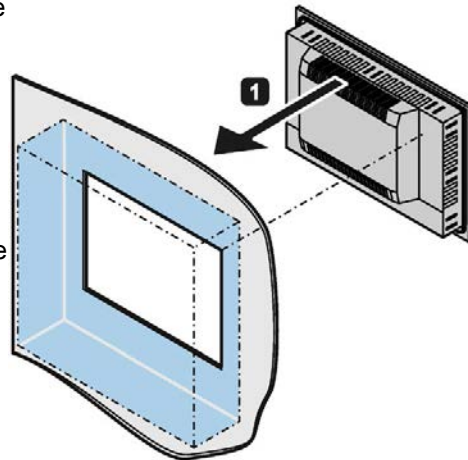

5. Check the fit of the mounting seal.

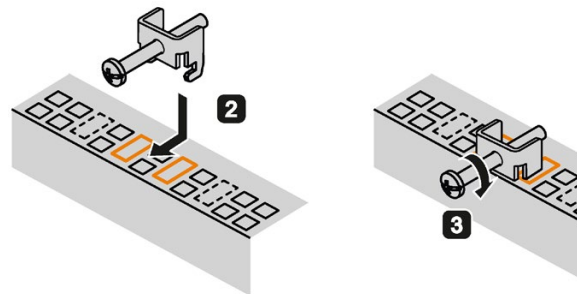

Mounting the device with mounting brackets

If there are strict requirements for the front seal, it might be necessary to fasten the device with mounting brackets in a cabinet. You can secure each device with 6 mounting brackets. The mounting brackets are available as accessories.

Requirement

- All packaging components and protective films have been removed from the device.
- The accessory mounting brackets are available.
- 2.5 mm hexagonal spanner

Procedure

Note

If the mounting seal is damaged or protrudes over the device, the degree of protection is not guaranteed.

1. Working from the front, insert the device into the mounting cut-out.

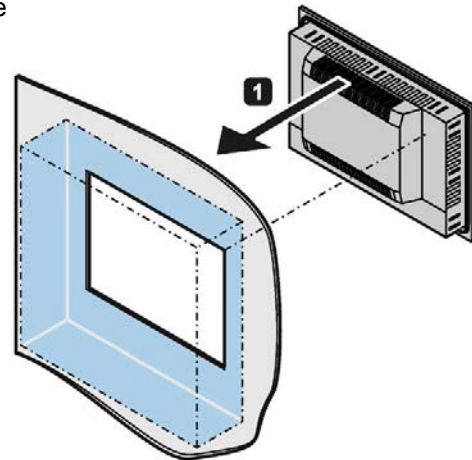

2. Insert the mounting clamp into the recesses on the device. Make sure it is in the correct position.

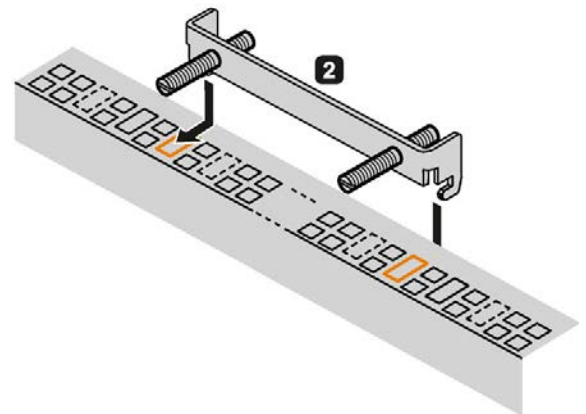

3. Secure the mounting bracket by tightening the threaded pins. The maximum permissible torque is 0.5 Nm.

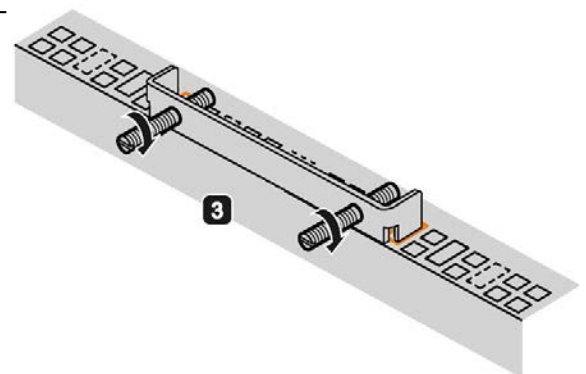

4. Repeat steps 2 and 3 until all mounting brackets are attached.
5. Check the fit of the mounting seal.

Positions of the mounting clips or mounting brackets for IP65

To achieve IP65 degree of protection for the device, the mounting clips or mounting brackets must be installed at the positions shown below.

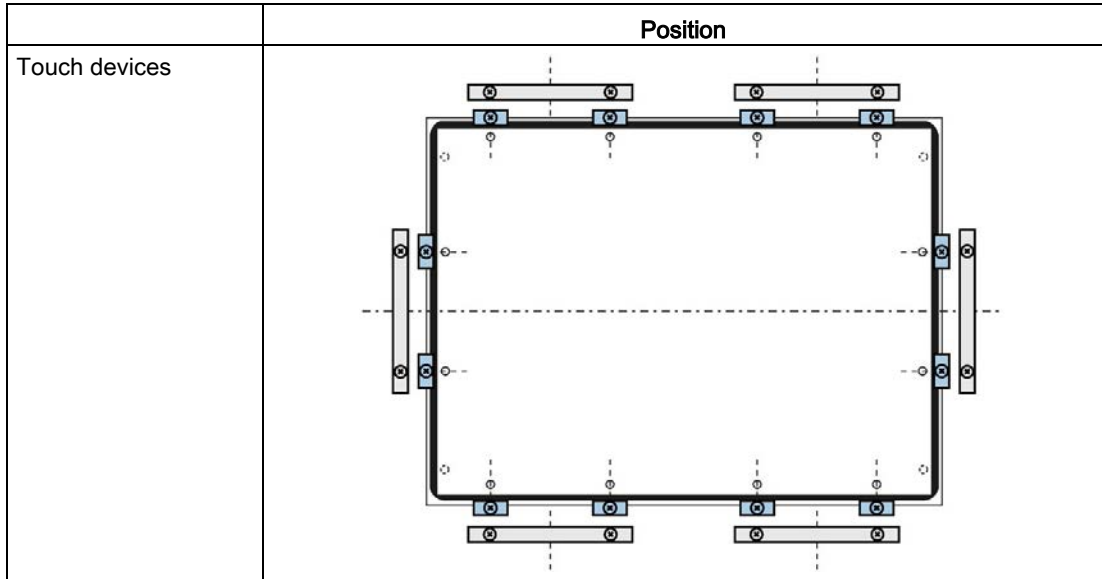

IP65 degree of protection

The installer of the plant is responsible for proper installation of the device.

⚠ WARNING
Risk of electric shock
The degree of protection cannot be guaranteed if the device is not correctly installed. Moisture or water can penetrate and cause electric shock or plant damage.
The IP65 degree of protection is ensured for the front of the device only if you observe the following:
<ul style="list-style-type: none">• Installation with mounting clamps• The circumferential seal is properly attached to a correctly sized cutout.• Follow the instructions when measuring the dimensions as shown in the section "Preparing the mounting cutout (Page 31)".

Position of the mounting clips for IP66-complaint installation

To achieve IP66 degree of protection instead of IP65, fasten 4 additional mounting clips at the positions marked by the red boxes. The 15" display meets IP66 even without additional mounting clips.

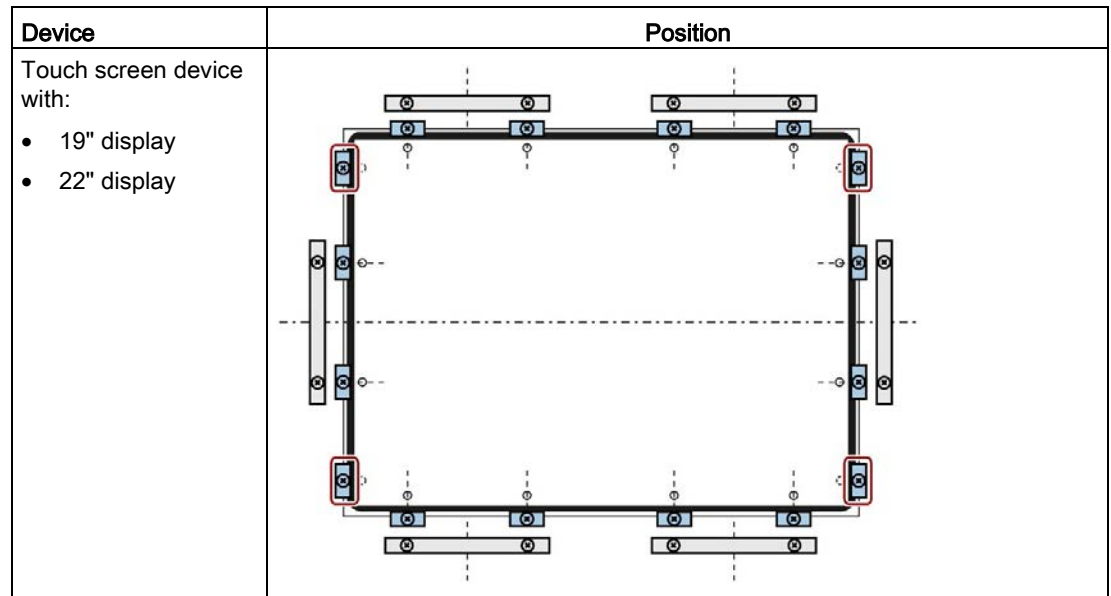

3.2.3 Mounting the device with mounting clips (multi-touch device)

Positions of the mounting clips

To achieve the degree of protection for the device, the positions for the mounting clips shown below must be adhered to.

Requirement

- All packaging components and protective films have been removed from the device.
- To install the device, you need the mounting clips from the accessory kit.
- The mounting seal on the front of the device is not managed.

Procedure

Note

If the mounting seal is damaged or protrudes from the device, the guaranteed degree of protection is not ensured.

It is prohibited from mounting the device if the mounting seal is damaged.

3.2 Mounting the device

1. Working from the front, insert the device into the mounting cut-out.

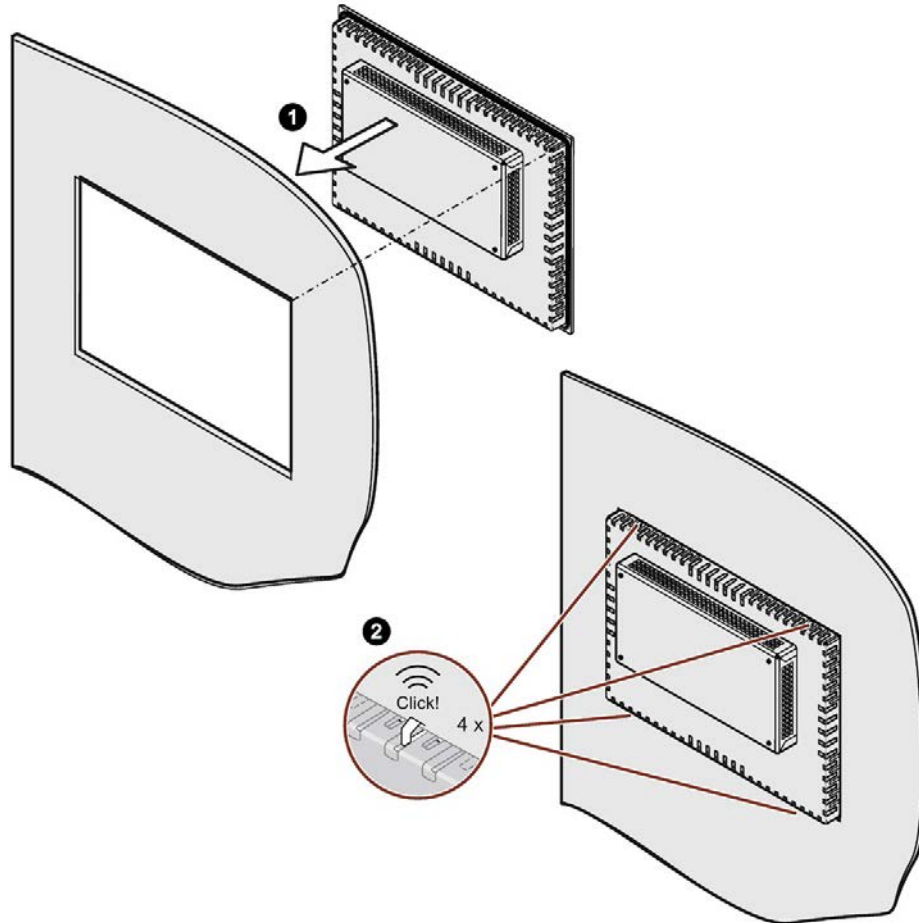

2. Make sure that all four spring fasteners latch fully into place on the upper and lower side of the device. If necessary, press the device again carefully into the mounting slot at the place that is not fully latched into position.

3. Insert a mounting clip into the cutout provided on the device.

Make sure it is in the correct position, see the section "AUTOHOTSPOT".

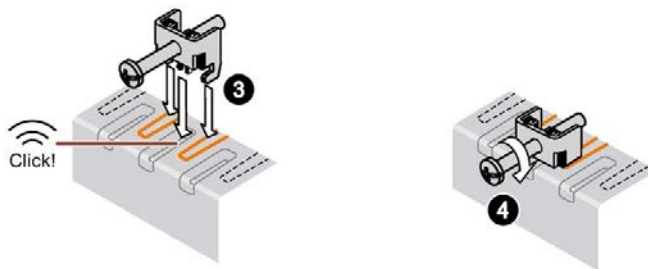

4. To secure the mounting clip, tighten the grub screw with the slot screwdriver, torque 0.5 Nm.
5. Repeat steps 3 and 4 until all mounting clips are securely fastened.
6. Check the fit of the mounting seal.

Position of the mounting clips for multi-touch devices

Fasten the mounting clips to the positions as illustrated.

Device	Position
24" display	
22" display	

3.2 Mounting the device

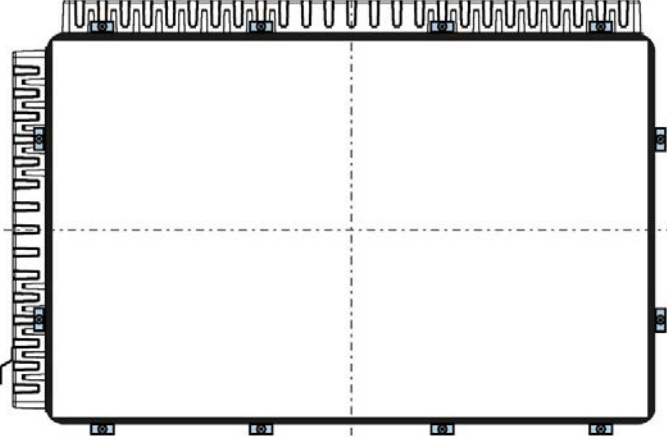
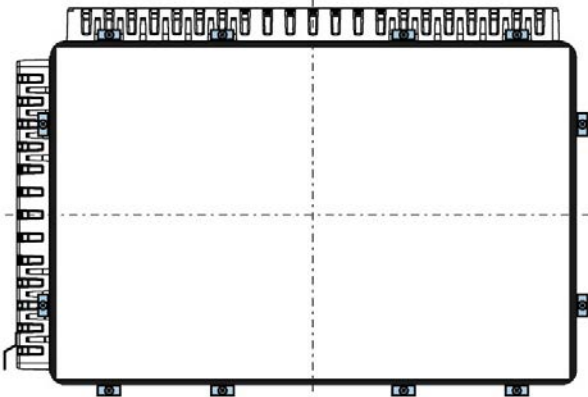
Device	Position
19" display	
15" display	

3.2.4 Fastening a device using a VESA adapter

You can also fasten the SIMATIC IPC477E up to a display size of 22" using a 100 x 100 mm VESA adapter.

Different models of VESA adapters are offered by third-party manufacturers.

<p>NOTICE</p>
<p>Degree of protection for overall device</p>
<p>If you are fastening the device via a VESA adapter, degree of protection IP65 of the device is lost.</p>
<p>Spray and water jets as well as penetrating substances can then damage the device.</p>
<p>It is not permitted to use device with VESA adapter in the scope of UL508.</p>

NOTICE

Dimensioning of the VESA adapter

When selecting the VESA adapter, make sure that it is designed for at least four times the weight of the device.

! WARNING

The device must be mounted securely

Inadequately dimensioned fastening material may cause the device to fall down. Serious bodily injury may result.

Make sure that fasteners are adequately dimensioned during installation of the device. Make sure to consider the weight of the device and the forces acting on the device when dimensioning the fasteners. This applies in particular to dynamic load of the device. All fasteners including mounting surfaces, support arm systems, and fastening elements such as screws must be able to carry at least four times the weight of the device.

Observe any further statutory specifications applying at the location of use of the device and further applicable regulations with regard to the fastening of the device.

Procedure

Remove the indicated screws and fasten the 100 x 100 mm VESA adapter at these points.

To do this, use M4x10 screws with property class 8.8 and tighten these with a torque of 3 Nm.



Additional information

Dimension drawings (Page 116)

See also

Environmental conditions (Page 134)

3.3 Connecting the device

3.3.1 Notes on connecting

 WARNING
Risk of fire and electric shock
The on/off switch does not isolate the device from the power supply. Risk of electric shock if the device is opened incorrectly or defective. There is also a risk of fire if the device or connecting lines are damaged.
You should therefore protect the device as follows:
<ul style="list-style-type: none">• Always pull out the power plug when you are not using the device or if the device is defective. The power plug must be freely accessible.• Connect the device to a protective conductor as instructed, see section "Connecting the protective conductor".• Use a central isolating switch in the case of cabinet installation.

 WARNING
Risk of lightning strikes
A lightning flash may enter the mains cables and data transmission cables and jump to a person.
Death, serious injury and burns can be caused by lightning.
Take the following precautions:
<ul style="list-style-type: none">• Disconnect the device from the power supply in good time when a thunderstorm is approaching.• Do not touch mains cables and data transmission cables during a thunderstorm.• Keep a sufficient distance from electric cables, distributors, systems, etc.

NOTICE
Fault caused by I/O devices
The connection of I/O devices can cause faults in the device.
The result may be personal injury and damage to the machine or plant.
Note the following when connecting I/O devices:
<ul style="list-style-type: none">• Read the documentation of the I/O devices. Follow all instructions in the documentation.• Only connect I/O devices which are approved for industrial applications in accordance with EN 61000-6-2 and IEC 61000-6-2.• I/O devices that are not hotplug-capable may only be connected after the device has been disconnected from the power supply.

NOTICE**Damage through regenerative feedback**

Regenerative feedback of voltage to ground by a connected or installed component can damage the device.

Connected or built-in I/Os, for example, a USB drive, are not permitted to supply any voltage to the device. Regenerative feedback is generally not permitted.

3.3.2 Power supply

3.3.2.1 Connecting the protective earth

A connected protective conductor conducts dangerous electrical charges away from the metal enclosure. The current flowing through the protective conductor when such a fault occurs triggers a primary fuse that disconnects the device from the power supply.

The protective conductor also improves the discharge of interference generated by external power cables, signal cables or cables for I/O devices to ground.

The connection for the protective conductor is labeled with the following symbol:

**⚠ WARNING****Electric shock and risk of fire**

High voltage may be present in a defective device, which can cause fire or an electric shock if touched. Death and serious bodily injury can result.

- Connect the device to the protective conductor before you put it into operation.
- The protective conductor connection on the device must be connected to the protective conductor of the control cabinet or system in which the device is installed.
- Never operate the device without protective conductor.
- If a device is defective, decommission it without delay and mark it accordingly.

Requirement

- The device is installed
- 1 protective conductor with minimum core cross-section of 2.5 mm²
- 1 T20 screwdriver
- 1 cable lug for M4

Procedure

The procedure is the same for all device variants and is described here as an example.

1. Clamp the cable lug onto the protective conductor.

2. Connect the cable lug to the screw at the designated protective conductor connection.



3. Connect the protective conductor to the protective conductor connection of the control cabinet in which the device is installed.

3.3.2.2 Connect 100-240 VAC power supply

The following procedure applies to a device that is connected to a 100 VAC - 240 VAC (-15 % / +20 %) power supply system, 50 - 60 Hz. The power consumption at 240 V can be up to 90 W, depending on device.

General connection information

Note the following in order to operate the device safely and according to regulation:

Note

The wide-range power supply is designed for 100 to 240 VAC power supply systems. It is not necessary to adjust the voltage range. The permitted nominal voltage of the device must conform with local mains voltage.

Note

Do not connect or disconnect power and data cables during thunderstorms.

! WARNING**Power supply system**

The device is intended for operation on grounded power supply systems (TN systems according to VDE 0100, Part 300, or IEC 60364-3).

It is not designed for operation on ungrounded or impedance-grounded power networks (IT networks).

Note**Power disconnection**

The power plug must be unplugged to fully isolate the device from mains. This location must be easy to access. There must be a central disconnect switch if the device is mounted in a control cabinet.

Always ensure that the socket on the device is freely accessible or that the grounding-type receptacle of the building installation is freely accessible and located as close as possible to the device.

Note

The power supply contains an active PFC (Power Factor Correction) circuit to conform to the EMC guidelines.

Uninterruptible AC power supplies (UPS) must supply a sinusoidal output voltage in the normal and buffered mode when used with SIMATIC IPCs with an active PFC.

UPS characteristics are described and classified in the standards EN 50091-3 and IEC 62040-3. Devices with sinusoidal output voltage in the normal and buffered mode are identified with the classification "VFI-SS-...." or "VI-SS-....".

Country-specific connection information

USA and Canada

For the United States and Canada, a CSA or UL-listed power supply cord must be used. The connector must conform to NEMA 5-15.

Country-specific power supply cords are available as accessories.

- **100 V supply voltage**

Use a flexible cable with UL approval and CSA mark and the following features:

- Type SJT with three conductors
- Conductor cross-section at least 18 AWG, ≤ 4.5 m in length
- Parallel grounding-type plug 15 A, at least 125 V

- **240 V supply voltage**

Use a flexible cable with UL approval and CSA mark and the following features:

- Type SJT with three conductors
- Conductor cross-section at least 18 AWG, ≤ 4.5 m in length
- Tandem grounding-type plug 15 A, at least 250 V

For countries other than the USA and Canada:

- **240 V supply voltage**

This device is equipped with a safety-tested power supply cord and may only be connected to a grounded power outlet. If this power cord is not used, a flexible cable with a conductor cross-section of at least 18 AWG must be used. The set of cables must conform to the safety regulations of the country in which the device is installed and bear the marks required in each case.

Requirement

- The device is installed.
- The protective conductor is connected, see the section "Connecting the protective earth (Page 45)".

Procedure

Connecting the power supply cord

1. Set the switch to the "Off" position, as shown.
2. Remove the marked screw of the power plug fastener.



3. Insert the power cable into the socket and fasten the power plug fastener with the marked screw.



Unplugging the power supply cord

⚠ WARNING

Risk of electric shock

The on/off switch does not disconnect the device from the power supply system.

Always unplug the power plug to disconnect the device from the power supply system.

Perform the steps for connecting the power supply cord in reverse order.

3.3.2.3 Connecting the terminal

The connection terminal for connecting the power supply is fitted to the device. The connection terminal is designed for cores with a cross-section of between 0.25 mm² and 2.5 mm². Only connect cores with a cross-section of ≥ 0.5 mm².

You can use either semi-rigid or flexible cables. You do not need to use end sleeves.

Requirements

- 1 connection terminal
- 1 0.5 x 3 Philips screwdriver

Procedure

NOTICE

Damage to the device

Do not adjust the screws in the connection terminal when it is plugged into the device. The pressure of the screwdriver on the connection terminal and the socket can damage the device.

Connect the wires to the connection terminal when it is not plugged in.

Note

Make sure that the cores are connected to the correct terminals. Observe the labeling for the contacts on the front cover of the device.

1. Connect the lines as shown. Make sure the connection terminal is in the correct position as shown.

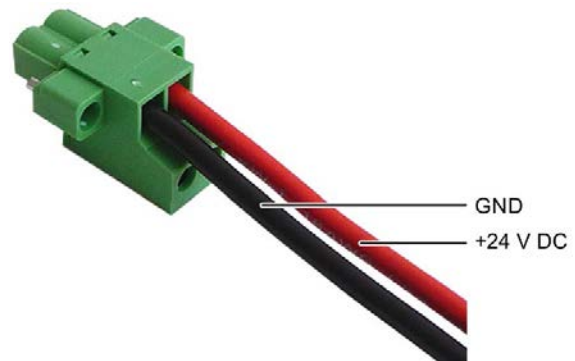

3.3.2.4 Connecting the 24 V DC power supply

Please note the following:

 WARNING
--

Electric shock and risk of fire
--

Voltages that exceed an extra-low voltage can cause electric shock or fire. Death or serious bodily injury can result.
--

- | |
|---|
| <ul style="list-style-type: none">• The device must only be connected to a 24 V DC power supply that meets the requirements of a safe extra-low voltage (SELV) according to the standards IEC/EN/DIN EN/UL 60950-1.• The supplying source must be fused for a power rating < 240 VA; recommended fuse rating ≤ 8 A. |
|---|

Note

The 24 VDC power supply must be adapted to the input data of the device (see the technical specifications in the operating instructions).

Requirements

- The device is installed.
- The protective conductor is connected.
- The connection terminal is wired.
- The corresponding 24 V DC power supply is switched off.

Procedure

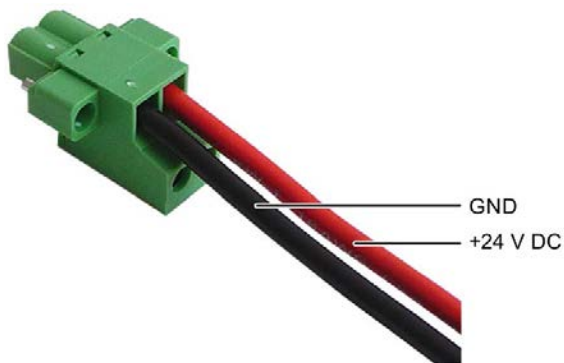

- 1** Switch off the 24 V DC power supply.
- 2** Connect the wires of the power supply.

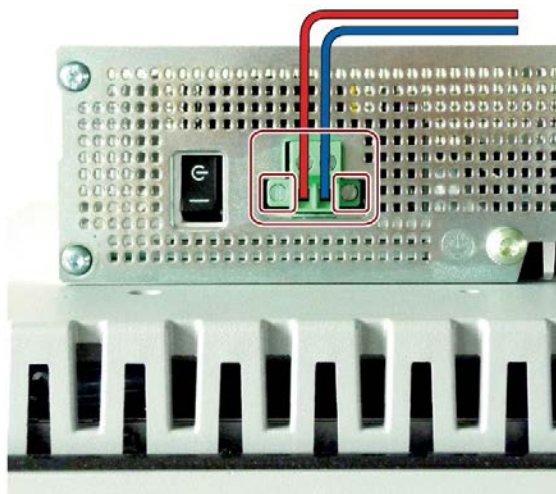

- 3** Connect the connection terminal at the marked position.
- 4** Secure the connection terminal with the marked screws.

3.3.3 Connecting peripheral equipment

Note**Ensure suitability for industrial applications**

Connect only I/O devices approved for industrial applications according to EN IEC 61000-6-2.

Note**I/O devices capable of hot-plugging (USB)**

I/O devices capable of hot-plugging (USB) may also be connected while the IPC is in operation.

NOTICE**I/O devices incapable of hot-plugging**

I/O devices incapable of hot-plugging may only be connected after the device has been disconnected from the power supply. Strictly adhere to the specifications for peripheral equipment.

Note

Wait at least ten seconds between removing and reinserting USB devices.

When using standard USB devices, bear in mind that their EMC immunity level is frequently designed only for office environments. These USB devices are adequate for commissioning and servicing purposes. Only industrial grade USB devices are permitted for use in industrial environments. The USB devices are developed and marketed by the respective provider. The product supplier in each case provides support for the USB devices. Moreover, the terms of liability of the individual vendors or suppliers apply here.

3.3.4 Connecting the device to networks

The following options are available for integrating the device in existing or planned system environments and networks.

Ethernet

You can use the integrated Ethernet interfaces (10/100/1000 Mbps) for communication and data exchange with automation devices, e.g. SIMATIC S7.

You need a suitable software to use this functionality: TIA Portal, STEP 7, WinCC, WinAC, SIMATIC NET.

Industrial Ethernet

You can establish a network between the device and other computers via Industrial Ethernet. The on-board LAN interfaces are twisted-pair TP interfaces that support data transmission rates of 10/100/1000 Mbps.

Note

You need a category 6 Ethernet cable for operation at 1000 Mbps.

SIMATIC NET

Use this software package to create, operate and configure an innovative network for Field & Control level. Information on this can be found on the SIMATIC NET Manual Collection CD. The software package and the documentation are not included in the product package.

Additional information

You can find additional information on the Internet at: Technical Support (<https://support.industry.siemens.com>)

3.3.5 Securing cables on the device

Different strain-relief assemblies are available to secure the cables.

The strain relief assemblies and the fasteners required for it are included in the product package.

The following cables can be secured:

- 24 V DC power supply cable
- RS232 cable
- USB cable
- DisplayPort line
- Ethernet cable

Requirement

- The device is installed
- Strain relief
- Screws
- Cable ties
- T10 screwdriver

Procedure

Attaching the strain relief is described as an example here. The procedure is the same for all device variants.

Installation the 24 V DC power supply connection

1. The 24 V DC power supply connection is screwed on to the device at the marked positions. Secure the connection cable to the nearest attachment eyelet with a cable tie.



Installation of the strain relief for the different connectors

The installation of this strain relief is a requirement for the installation of the strain reliefs for the Ethernet, DP and USB connections described below.

Screw on the strain relief with 4 screws at the marked positions.



Installation of the strain relief for the Ethernet connections

If necessary, screw on the strain relief with a screw at the marked positions.



Installation of the strain relief for the DP and USB connections

Note

IECEX/ATEX

This strain relief is only designed for use of the IPC in hazardous areas (ATEX/IECEX).

If no ATEX/ICEEx requirement exists, the cables are secured via the "Strain relief for different connectors".

If necessary, screw on the strain relief with a screw at the marked positions.



Securing the connector

Secure each connector with a cable tie.

① Secure the COM interface (optional) with the screws indicated for this.

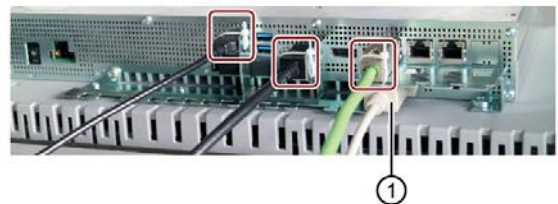

Commissioning the device

4.1 Notes on commissioning and operation

⚠ CAUTION**Danger of burns**

The surface of the device can reach temperatures of over 70 °C. Any unprotected contact may cause burns.

Avoid direct contact during operation of the device. Touch the device only with appropriate protective gloves.

Note**Windows Embedded Standard 7 - Note the EWF and FBWF information**

Two configurable write filters (Enhanced Write Filter and File Based Write Filter) are provided with Windows Embedded Standard. Read the EWF/FBWF information if you activate and use them, otherwise you may experience data loss.

- Enhanced Write Filter (EWF) (Page 70)
 - File Based Write Filter (FBWF) (Page 73)
-

Note**Configuring memory cards in the device**

Memory cards used in a device need to be configured on that device. Memory cards configured on other devices will not boot as the drive parameters will be different.

Notes on operation

Note**During the startup procedure...**

- Make sure that there are no conductive liquids on the touch screen during startup.
 - Do **not** touch the touch screen during startup.
The device automatically calibrates the touch screen during startup.
-

Requirement

- The device is connected to the power supply.
- The protective conductor is connected.
- The connection cables are plugged in correctly.
- The following hardware is available for initial commissioning:
 - One USB keyboard
 - One USB mouse

4.2 Initial commissioning

Following the initial switch-on, the operating system pre-installed on the device is set up automatically on the device.

NOTICE
Faulty installation
If you change the default values in the BIOS setup or if you turn off the device during installation, you disrupt the installation and the operating system is not installed correctly. The operating safety of the device and the plant is at risk.
Do not switch off the device during the entire installation process. Do not change the default values in the BIOS setup.

Procedure - Switching on the device

1. Set the on/off switch to the "ON" position.

The module carries out a self-test. During the self-test, the following message appears:

`Press ESC for boot options`

2. Wait for the message to disappear.
3. Follow the instructions on the screen.
4. Make the region and language settings.

If you want your system language to be international, select English. Information about changing the region and language settings subsequently can be found in the section "Installing the software" under "Maintaining and servicing your device".

Note

Once the operating system has been set up, the device may restart.

5. Type in the product key as required.

The product key is located on the "Certificate of Authentication", in the "Product Key" line.

Result

The interface of the operating system is displayed every time you turn on the device and after the startup routine.

Procedure - Switching off the device

To turn off the device, always select "Start > Shutdown".

If the device is not going to be used for a long period of time after shutdown, set the on/off switch to the  position.

NOTICE

Disconnecting the device from the power supply

The on/off switch does not separate the device from the mains. To de-energize the device, remove the power supply terminal.

Additional information

Information on your operating system can be found on the Internet:

- Microsoft® Windows® 7
(<https://support.industry.siemens.com/cs/ww/de/view/109749497/en?dl=en>)
- Microsoft® Windows® 10
(<https://support.industry.siemens.com/cs/ww/de/view/109749498/en?dl=en>)
- Microsoft® Windows Embedded Standard® 7
(<https://support.industry.siemens.com/cs/ww/de/view/109749499/en?dl=en>)

4.3 Windows Action Center

Warning from the Windows Action Center

The Action Center checks the status of the device with regard to the important safety aspects listed below. If a problem is found, the Action Center provides recommendations on how you can better protect the device.

- **Firewall:** The Windows Firewall adds protection to the device by blocking network or Internet access to the device by unauthorized users. The firewall is enabled in the delivery state.
- **Antivirus software:** Antivirus programs add protection to the device by searching for and eliminating viruses and other security threats. No antivirus software is installed in the delivery state.
- **Automatic updates:** Using the Automatic Update feature allows Windows to regularly search for the latest critical updates for the device and to install them automatically.
This option is enabled in the delivery state for Windows 7 and Windows 10.
- **User Account Control:** User Account Control issues a warning when programs attempt to modify important Windows settings. You can then either acknowledge this warning or prevent the program from changing the Windows settings.
This option is enabled in the delivery state.

Operating the device and device functions

5.1 Operator input options

Depending on your device and the connected I/O devices, the following operator input options are available:

- Touch screen for touch device
- Screen keyboard for touch device
- External keyboard, connected via USB
- External mouse, connected via USB

CAUTION

Unintentional actions with touch screen operation

If you touch the touch screen while system-internal processes are running, unintended reactions of the device might be triggered.

Do not touch the screen in the following situations:

- During the boot process
- When plugging or unplugging USB components
- While Scandisk is running
- During a BIOS update

NOTICE

Damage to the touch screen

Impact with hard objects as well as touching the touch screen with pointed or sharp objects can damage it and lead to a significant reduction in service life or even total failure of the touch screen.

Never touch the touch screen with pointed or sharp objects. Only touch the touch screen with your fingers, a touch stylus or an approved touch glove.

 **WARNING**

Personal injury or property damage due to incorrect operation

Incorrect operation of devices with a touch screen can occur. This can result in personal injury or property damage.

Take the following precautions:

- Configure the plant so that safety-related functions are not operated with the touch screen.
- Switch off the device for cleaning and maintenance.
- Make sure that the touch screen is kept free of dirt.

For resistive single-touch screen:

- Always touch only a single point on the touch screen.
- Calibrate the touch screen regularly, at the latest when the touch screen becomes inaccurate or does not respond despite repeated touches.

5.2 Operating a device with resistive single-touch screen

When you touch an object on the single-touch screen, the corresponding function is performed.

Note

Appearance of blisters under extreme ambient conditions

Under extreme environmental conditions such as high atmospheric humidity and temperature, bubbles can form on the touch surface in rare cases. This only affects the appearance and does not represent any functional restriction.

5.3 Operating a device with capacitive multi-touch screen

You operate the multi-touch screen with one or multiple fingers. You can also operate it using gestures with up to five fingers at a time.

WARNING

Danger of malfunction due to improper execution of gestures on the touch screen

If gestures are executed incorrectly on the touch screen with multi-touch function, these gestures might not be recognized or could be recognized incorrectly. The entries made are then not implemented by the device or are implemented incorrectly or in an unintended manner.

Incorrect execution of multi-touch functions can lead to errors in the operation of the plant and thus to physical injury.

Note the following when operating the touch screen with multi-touch function:

- The touch screen reacts to contact on its surface, not to pressure.
- When using a touch pen: Operate the touch screen only with a touch pen for capacitive touch.
- Avoid unintended multiple touches, for example, with your knuckles.

Before you start to operate the device, make sure you are familiar with the multi-touch functions of the Windows operating system, as well as with the application to be used and its functions. Ensure that the gestures which the user executes on the multi-touch display are recognized by the application. It is possible that certain gestures need to be trained beforehand.

WARNING

Personal injury or property damage due to no protective conductor

An inadequate protective conductor or the lack of one might cause malfunction of the capacitive touch screen. Functions may not work properly. This can result in personal injury or property damage.

- Always connect the device to a protective conductor.
- Additional information on connecting the protective conductor can be found in the section "Connecting the protective earth (Page 45)."

Notes on operation

Note when operating the multi-touch screen:

- Surface contact with a diameter of about 5 to 20 mm is required for an operator action to be detected.
- An operation with gloves with a material thickness of <2 mm is detected in most cases. However, check the usefulness of the gloves you are using.
- To avoid incorrect operation, certain inputs are ignored and blocked from further entry:
 - Simultaneous operation with more than 5 fingers.
 - Surface contact with a diameter of > 3 cm, for example, resting the palm of the hand on the touch screen
 - As soon as the touch screen is no longer touched, input is possible again.

Functions of the multi-touch screen

General functions

- Detection of up to 5 finger touches at a time.
- Detection of gestures that are supported by the operating system or the software installed on the device.

Note

Multi-touch operation can provide advanced features or pose limitations depending on the operating system and the software installed on the device. Read the corresponding documentation.

- You do not need to calibrate the touch screen. Some operating systems do offer touch calibration. However, this calibration does not lead to improved accuracy.

Security functions in an industrial environment

The touch screen is locked for security reasons when the following happens:

- There is a conductive liquid on the touch screen with ground contact via the enclosure or the operator, for example.
- Electromagnetic interference is present that exceeds the specification according to EN 61000-4-2.

Once the interference is over, the touch screen is no longer locked.

5.4 IPC Driver and Tools

Panel description - Panel Drivers and Tools software

The SIMATIC IPC PDT software installs the "IPC Configuration Center" and, optionally, the "IFP Ethernet Monitor" software.

The existing hardware components are automatically detected by the associated software.

The most important features of the software are:

- Dialog-guided installation
- Configuration via the IPC Configuration Center of:
 - Brightness
 - Screen saver
 - Tools
 - Touch settings
 - Ethernet Monitor settings

All other functions are described in the IPC Panel Driver and Tools operating manual.

5.5 Extended device functions

5.5.1 Monitoring functions

5.5.1.1 Overview of the monitoring functions

The basic version of the device also provides monitoring functions. The following display, monitoring and control functions are available when the appropriate software is used:

- Temperature monitoring: Overtemperature, undertemperature, or cable break at a temperature sensor
- Monitoring of drives with S.M.A.R.T. functionality
- Watchdog: Hardware or software reset of the computer
- Operating hours counter: Information about total time of operation
- Battery monitoring: The charge level of the battery is monitored.

SIMATIC IPC DiagBase software

Use the functions of the SIMATIC IPC DiagBase software included in the scope of delivery for local monitoring. Use the "DiagBase Management Explorer" application to obtain a clear overview of the controls. Use the DiagBase Alarm Manager to receive notifications about individual alarms.

Note

For more information on SIMATIC IPC DiagBase software functionality, please refer to the relevant Online Help.

SIMATIC IPC DiagMonitor software

SIMATIC IPC DiagMonitor is available on CD (not included in the scope of delivery). The CD contains both the monitoring software and the software for the stations to be monitored. The interface specifications and a library for creating your own applications are also provided.

5.5.1.2 Temperature monitoring/display

Three temperature sensors monitor the temperature of the device at several positions:

- Processor temperature
- Temperature close to the RAM ICs/chips
- Temperature in proximity of the air inlet

A temperature error is triggered under these circumstances:

- The configured low threshold for the temperature has been violated.
- The configured high threshold for the temperature has been violated.

A temperature error causes the following reaction:

Reaction	Option
Alarm window of the DiagBase or DiagMonitor software alerts the user.	None

The temperature error is saved until the temperatures have fallen below the thresholds and it is reset by one of the following measures:

- Acknowledgment of the error message by the user with DiagBase or DiagMonitor software
- Restart of the device

5.5.1.3 Watchdog (WD)

Configuration

You configure the watchdog with the DiagBase or DiagMonitor software.

Function

The watchdog is able to monitor system runtime and informs the user about the different reactions that are triggered if the system does not respond to the watchdog within the specified monitoring time.

A watchdog alarm is retained after a restart and is reset and logged by the DiagBase or DiagMonitor software. The watchdog configuration is retained in the process.

Watchdog reactions

The following reactions can occur if the watchdog is not addressed within the set time:

Option	Reaction
Reset on	Executes a hardware reset when the watchdog expires
Reset off ¹	Executes no action when the watchdog expires
Restart ¹	Restarts the operating system when the watchdog expires
Shutdown ¹	Shuts down the operating system when the watchdog expires

¹ Option is device-specific.

NOTICE

"Reset on" option

The "Reset on" option immediately triggers a hardware reset that may result in loss of data under Windows and damage to the installation.

Watchdog monitoring times

The monitoring time can be configured with the DiagBase or DiagMonitor software.

Note

When you change the monitoring time, the change becomes effective immediately.

5.5.1.4 Battery monitoring

The installed backup battery has a limited service life, see section "Replacing the backup battery (Page 91)". A two-tier battery monitoring checks the status of the backup battery. The SIMATIC DiagBase and SIMATIC DiagMonitor diagnostic software determines the status of the backup battery.

When the first warning level is reached, the battery for buffering CMOS data still has a remaining service life of at least one month.

5.5.1.5 Mass storage monitoring

The state of HDD, SSD and CFast cards is monitored via SMART bit and reported by DiagBase or DiagMonitor.

5.5.2 Unified Write Filter (UWF)

The Unified Write Filter is a configurable write filter that makes it possible to assign write-protection to data storage media, such as hard disks, CFast cards, SSDs, internal USB drives, or external SATA drives.

External removable data storage media such as USB sticks and other flash drives, which are recognized by the operating system as a removable data storage medium, are not supported.

UWF combines the advantages of older write filters such as EWF and FBWF. It prevents all write access to protected media and transfers the data to buffer memory (overlay). This increases the reliability and stability of the system as well as the service life of write-sensitive media such as SSDs and CFast cards.

Note

UWF is disabled in the delivery state.

Note that memory is reduced when UWF is enabled.

NOTICE
Risk of data loss with enabled UWF
When UWF is enabled, all changes made to storage media with a UWF write protection after booting can be lost when the device is shut down. Proceed as follows to prevent this situation:
<ul style="list-style-type: none">• Make changes to storage media only when UWF is disabled.

5.5.3 Enhanced Write Filter (EWF)

Purpose and function

The Enhanced Write Filter (EWF) is a function that is only available for Windows Embedded operating systems. EWF is a write filter that can be configured by the user.

You can use the Enhanced Write Filter to boot Windows Embedded Standard from read-only media, for example, memory cards or Solid State Drives (SSD), or provide individual partitions with write protection.

EWF can be used to minimize write access to storage media. This is important because the write cycles are limited due to technical reasons. We therefore recommend using EWF if you work with these storage media.

If you use HORM or compressed NTFS, EWF is indispensable.

NOTICE
Data loss with several write filters
Both EWF and FBWF are preinstalled in the SIMATIC IPC images. If several write filters are active on one partition at the same time, you may experience data loss. This may damage the machine or plant.
Make sure that you only activate one write filter for each partition.

Note

Windows Embedded Standard

The Enhanced Write Filter is deactivated in the Windows Embedded Standard default state.

- Back up your data after installation of the operating system and programs.
 - Activate the EWF.
-

Setting EWF

The following programs can be used to install, enable or disable the EWF:

- EWFMgr.EXE
- SIMATIC IPC EWF Manager.

The SIMATIC IPC EWF Manager is preinstalled and included on the supplied USB stick (DocuAndDrivers\Drivers).

Start the SIMATIC IPC EWF Manager as follows:

- "Start > All Programs > Siemens Automation > SIMATIC > EWF Manager > EWF Manager"

Configure the SIMATIC IPC EWF Manager as follows:

- "Start > All Programs > Siemens Automation > SIMATIC > EWF Manager > EWF Settings"
- or
- Click the "SIMATIC IPC EWF Manager" icon in the system tray.

The following functions are available:

Function	Command
Write-protect drive C: Power on	<code>ewfmgr c: -enable</code>
Write-protect drive C: disable: the modified data are applied	<code>ewfmgr c: -commitanddisable</code>
Modified data on drive C: apply	<code>ewfmgr c: -commit</code>
Display information about the EWF drive	<code>ewfmgr c:</code>
Display help	<code>ewfmgr /h</code>

Note

The EWF commands affecting the write protection do not become active until after the next booting process.

Note

The EWF command `ewfmgr c: -commitanddisable` may not be used with the option `-live`.

Special notes for use

If EWF is enabled, when the PC shuts down all changes made on drive C: after the boot process are lost.

These changes are only retained on the PC in the following cases:

- EWF is disabled when you make changes.
- EWF is enabled and you save the changes before shutting down the device using the following command on C: drive :

```
ewfmgr c: -commit
```

Note

When the system is set to automatically adjust the clock for daylight saving time adjustment, systems without central time management and with activated EWF set the clock forward or backward by one hour in the daylight saving time or standard time period each time the system boots.

The reason for this behavior is that Windows Embedded Standard 7 makes a registry entry that the changeover to daylight saving time has occurred. Since this file is also protected against modification by the EWF, the marker is lost during the boot sequence and the adjustment is made again.

We therefore recommend that you deactivate the automatic adjustment and change the clock manually.

Follow these steps:

1. Deactivate automatic adjustment in the Control Panel: In the "Time Zone" tab opened with the menu command "Start > Control Panel > Date and Time", remove the check mark from the "Automatically adjust clock for daylight saving changes" check box.
 2. Save the change you have made with `ewfmgr c: -commit` and then reboot the system.
-

5.5.4 File Based Write Filter (FBWF)

Purpose and function

With the Feature Pack 2007 for Windows XP Embedded Standard 7, Microsoft introduced a second write filter, File Based Write Filter (FBWF).

In contrast to EWF, which protects partitions based on sectors, FBWF works on the file level. When FBWF is enabled, all files and folders of a partition are protected unless they are included in an exception list.

FBWF is disabled by factory default in the operating system images for SIMATIC IPC and must be enabled and configured by the user.

When you enable FBWF, the folders C:\FBWF and D:\FBWF are authorized for writing by default.

Comparison between EWF and FBWF

- You should prefer FBWF, because it is more flexible in its configuration and allows immediate writing without rebooting.
- If you use HORM or compressed NTFS, EWF is indispensable.

CAUTION

Data loss with several write filters

Both EWF and FBWF are preinstalled in the SIMATIC IPC images. If several writer filters are active on one partition at the same time, you may experience data loss. This may damage the machine or plant.

Make sure that you only activate one write filter for each partition.

Configuring FBWF

FBWF can be configured in command console using the program FBWFMGR.EXE.

Note

- Observe the following syntax: Enter a **space** after the drive designation colon.
- Changes for direct write access only take effect after rebooting.
- Only existing files and folders can be entered in the exception list.

Function	Command
Display the current FBWF status	fbwfmgr /displayconfig
Enable FBWF after the next startup	fbwfmgr /enable
Write to protected files	fbwfmgr /commit c: \Test.txt
Adding/removing elements in the exception list:	
• Add file	fbwfmgr /addexclusion C: \Test.txt
• Add folder	fbwfmgr /addexclusion C: \Test folder
• Remove file	fbwfmgr /removeexclusion C: \Test.txt
• Remove folder	fbwfmgr /removeexclusion C: \Test folder
Call up the help function	fbwfmgr /?

Detailed instructions on FBWF are available on the Internet ([http://msdn.microsoft.com/en-us/library/aa940926\(WinEmbedded.5\).aspx](http://msdn.microsoft.com/en-us/library/aa940926(WinEmbedded.5).aspx)).

5.5.5 Buffer memory NVRAM

Depending on the configuration you ordered, the motherboard is equipped with a non-volatile memory (NVRAM) that applications can use to back up data in the event of a power failure. Failure of the supply voltage for a duration longer than 5 ms is indicated by the DC FAIL signal.

Depending on the system utilization, up to 512 KB can be saved in the NVRAM.

A memory window with a maximum size of 512 KB can be displayed by means of PCI address register. The base address is initialized by the BIOS.

A corresponding function is implemented there for using the NVRAM under WinAC RTX and for using the CPU150xS SW controller.

5.5.6 Active Management Technology (AMT)

Depending on the processor version you ordered, the device is equipped with AMT (Active Management Technology).

AMT is technology for the remote maintenance of computers, simply called AMT-PC in the remainder of the document, which includes the following functions:

- Keyboard Video Mouse (KVM) Redirection: Using KVM that is integrated in the AMT hardware you access the AMT PC remotely. With KVM, you can also control AMT PCs that have no operating system or a defective operating system. A KVM remote session is always possible with the KVM server integrated in the firmware. This means you can restart the PC and change the BIOS setup remotely.
- Remote power management: AMT PCs can be turned on and off and restarted from another PC.
- SOL (Serial over LAN): Redirection of the data of a serial interface to the network. The main use of the function is text-based remote control of an AMT PC using a console.
- IDE redirection: An ISO file on the help desk PC can be mounted on the AMT PC and used as a DVD drive.

An ISO file contains a memory image of the content of a CD or DVD structured in the ISO 9660 format.

- Remote reboot: An AMT PC can be booted from a bootable ISO file made available by another PC.

SIMATIC IPC Remote Manager

The "SIMATIC IPC Remote Manager" software is available for utilization of the AMT functions with SIMATIC IPCs. The software can be ordered from the Siemens online ordering system. For detailed information about "SIMATIC IPC Remote Manager", refer to the corresponding product documentation: SIMATIC IPC Remote Manager (<http://support.automation.siemens.com/WW/view/en/48707158>)

Typical areas of application and functions of the SIMATIC IPC Remote Manager:

- Remote maintenance of SIMATIC IPC with AMT, for example for service purposes in the case of a defective operating system or for adapting BIOS settings.
- Diagnostics without on-site use
- Convenient service: Access to AMT clients, such as headless systems, without additional hardware
- Resource management

Requirement

- A device with Xeon or Core i5 processor
- A functioning and configured management engine
- A functioning and configured Ethernet connection
- A help desk PC with a functioning and configured Ethernet connection for the full AMT functionality

Configuration of the AMT PC

You configure AMT by means of the BIOS setup and MEBx (Management Engine BIOS Extension). MEBx is a BIOS extension for configuration of AMT (see BIOS description in chapter "Technical specifications").

5.5.7 Trusted Platform Modul (TPM)

Depending on the ordered configuration, the motherboard contains a Trusted Platform Module (TPM). A TPM is a chip that adds important security functions to your device, such as enhanced protection of the PC against unauthorized manipulation by third parties. The current operating systems, for example, Windows 7 or Windows 10, support these security functions.

NOTICE
Import restrictions
TPM technology is subject to legal restrictions in some regions and may not be used there. You could commit a crime by importing or exporting the device in certain countries.
Note the respective import provisions for the TPM module.

Activating the Trusted Platform Module

The TPM can be activated under "Security" in the BIOS setup. Please follow the instructions in the BIOS setup.

Using the Trusted Platform Module

The TPM can be used in Windows with the "BitLocker" drive encrypter.

The Windows operating system is installed in UEFI mode in the delivery state for this purpose. It is not possible to use BitLocker under Window Embedded operating systems because these are installed in MBR mode.

To use BitLocker, follow the relevant instructions in the operating system.

Note**Risk of data loss**

If you lose the password for the drive encryption, you will not be able to restore the data. You will then lose access to the encrypted drive.

The warranty does not cover a reset of the hardware in the event of a loss of a password.

Please store the password carefully and make sure it is protected against unauthorized access.

Expanding the device and assigning device parameters

6

6.1 Open the device.

The device must be opened in order to install a memory expansion. Read the information in the section "ESD guideline (Page 113)" when doing this.

Opening device with expansions

To open devices with the PCIe card expansion, you first have to dismantle this expansion. You can find additional information on this in the following section:

- Install and remove PCIe card (devices with PCIe card) (Page 82)

Opening device without expansions

For devices without expansions, only the rear panel of the device is removed.

Requirement

- The device is disconnected from the power supply.
- All cables are removed from the device.
- The device is removed.
- T10 screwdriver

Procedure

1. Remove the screws marked in red.
2. Loosen the screws marked in green.

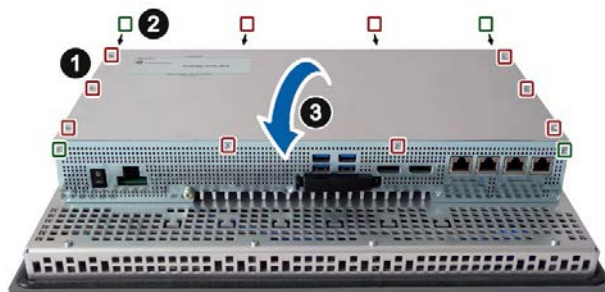

3. Remove the rear panel of the device.

6.2 Installing and removing a memory module

The procedures for installing and removing the memory module are the same for all device variants.

The motherboard is equipped with one slot for an SO-DIMM DDR4 memory module. You can use it to expand the memory capacity of the device to a maximum of 16 GB.

Note

Use only the memory modules recommended by Siemens AG. You can find additional information in the section "Accessories (Page 17)".

Requirements

- The device is disconnected from the power supply.
- The device is open.

Procedure

NOTICE
Note the protective measures required when working with ESD in the section "ESD guideline (Page 113)".

Removal

1. Press the marked latches towards the outside.
The memory module tilts forward.
2. Pull the memory module out of the slot in the direction of the arrow.

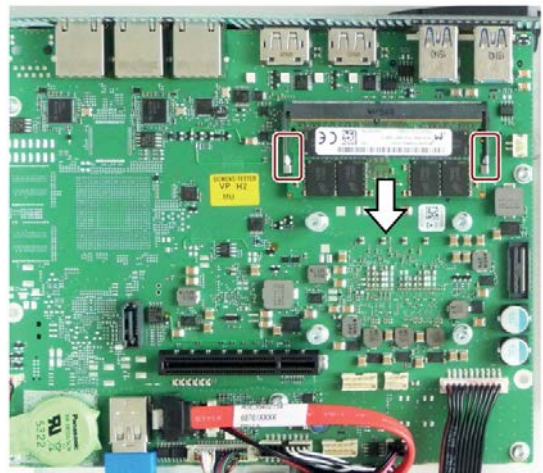

Installation

1. Insert the memory module into the marked slot at an incline with the contact side toward the motherboard.
2. Carefully press the memory module into the contact strip until the latches engage.



6.3 Install and remove PCIe card (devices with PCIe card)

The following section describes the installation and removal of a PCIe card with devices that are expanded with a PCIe card.

Requirements

- The device is disconnected from the power supply.
- The device is removed.
- 1 PCIe card
- 1 T10 screwdriver

Procedure

NOTICE

Note the protective measures required when working with ESD in the section "ESD guideline (Page 113)".

Installation

1. Remove the marked screws and take off the rear panel of the of the enclosure.
2. Remove the marked screws and pull out the blanking plate.

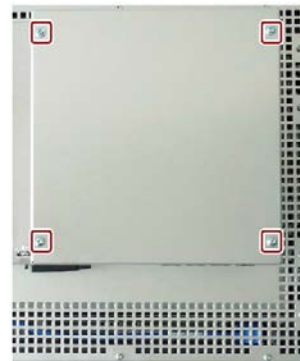

3. Remove the highlighted screw of the PCIe card holder.



4. Insert the PCIe card in the direction of the arrow and secure this with the marked screw.



5. Push the PCIe card holder in the direction of the PCIe card and secure this with the marked screw.

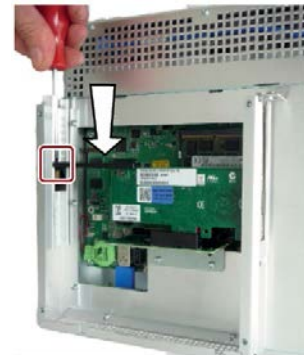

6. Close the device.

Removal

Follow the steps for installation in reverse order.

6.4 Installing and removing a CFast card (external slot)

A slot for a CFast card is located on the bottom of the device. Installing and removing the CFast card is the same for all device variants.

Use only SIMATIC IPC CFast cards for industrial application.

Requirement

NOTICE
Note the following points: <ul style="list-style-type: none">• Use the slot described here exclusively for a CFast card.• Do not insert CompactFlash cards (CF cards) into the slot for the CFast card.• Always replace the SIMATIC IPC CFast card with a SIMATIC IPC CFast card of the same production version or higher. For the SIMATIC IPC477, only SIMATIC CFast cards with production version 02 or higher may be used. The production version can be found on the SIMATIC IPC CFast card, see the section "Accessories (Page 17)".

- The device is disconnected from the power supply.
- SIMATIC IPC A CFast card that is approved for industrial use.

Procedure

The procedure for installing and removing the CFast card in an external slot is the same for all device variants.

Installation

NOTICE
Inserting a memory card <p>If you are using the memory card in a device installed in a system, you must observe the safety regulations for work on electrical systems.</p>

Note

Carefully insert the CFast card into the slot without applying excess force.

1. Release the lock of the cover.

In so doing, press against the cover in the direction of the arrow. Open the cover completely.



2. Insert the CFast card into the external slot as shown in the figure.

Push the CFast card into the slot until it clicks into place (ballpoint pen mechanics).



3. Close and lock the cover.

Removal

Perform the steps in reverse order.

6.5 Assigning CPU power consumption parameters

The CPU can be switched to one of the following modes via a BIOS Setup setting (BIOS setup > Menu "Power" > "Power&Performance" > "CPU Power Management Control" > "CPU Power Level"):

Operating mode	Description
Standard	Default setting The CPU clock is dynamically limited with maximum 3D graphics performance. The maximum CPU power consumption is 17 W.
Performance optimized	Setting the high performance for CPU and Graphics at the same time. The maximum CPU power consumption is 25 W. Note: The maximum permitted ambient temperature is reduced by 5° C with this setting.
Determinism optimized	Same as standard, but additionally optimized for deterministic operation with constant CPU frequency.
Temperature optimized	Setting for lowest power consumption. The CPU clock is limited at a higher load. The maximum power consumption of the CPU is 12 W.

Maintaining and servicing your device

7.1 Maintenance

To maintain high system availability, we recommend the preventative replacement of those PC components that are subject to wear. The table below indicates the intervals for this replacement.

Component	Replacement interval:
Hard disk drive	3 years
CMOS backup battery	5 years
SSD / CFAST card	Depends on the type of use ¹

¹ The interval for replacement depends greatly on the type of use. A specific interval cannot be given.

All drives are monitored with the software tools DiagBase or DiagMonitor on the basis of their SMART status. As soon the SMART status of the HDD or SSD switches to "Not OK", a message is sent in DiagBase or DiagMonitor, or when you start up the PC. You should then back up your data and replace the drive.

7.2 Repair information

Making repairs

Install only system expansions approved for this device. If you install other expansion devices, you may damage the device or violate the safety requirements and regulations on RF suppression. Contact your technical support team or where you purchased your PC to find out which system expansion devices may safely be installed.

 WARNING
Opening the device Unauthorized opening and improper repairs on the device may result in substantial damage to equipment or endanger the user. If you install or replace a system expansion and damage your device, the warranty will become void. The device may only be repaired by qualified personnel.

Safety when working in and on electrical systems

Work in or on electrical systems may only be carried out by authorized persons. The following safety regulations apply in Germany for the prevention of electric shock and electrocution:

1. Switch off the system
2. Secure the system to prevent it switching back on
3. Check the system to ensure it is de-energized
4. Ground and short the system
5. Cover or shield adjacent live parts

These safety rules are based on the DIN VDE 0105 standard.

Note

These safety steps must always be taken in the above order before any work on electrical systems. Once work on an electrical system is finished, cancel the safety steps starting with the last and finishing with the first.

In accordance with the applicable safety regulations, clearly indicate on an electrical system that work on it is underway.

Observe the safety regulations applicable in the country of operation.

 CAUTION
--

Electrostatic-sensitive components

The device contains electronic components which are destroyed by electrostatic charges. This can result in malfunctions and damage to the machine or plant.

Make sure you take precautionary measures even when you open the device, for example, when opening device doors, device covers or the housing cover. For more information, refer to the section "ESD Guideline (Page 113)"
--

 WARNING
--

Risk of explosion and release of harmful substances
--

Improper handling of lithium batteries can result in an explosion of the batteries. Explosion of the batteries and the released pollutants can cause severe physical injury.
--

Observe all safety and handling instructions for lithium batteries. Do not expose lithium batteries to flames and do not solder the battery cell. Do not recharge, open, or short lithium batteries. Do not reverse lithium battery polarity or heat the batteries to over 100°C. Keep lithium batteries out of direct sunlight and protect them from moisture and condensation.
--

Note the following when handling lithium batteries:

- A worn battery jeopardizes the function of the device. Change the battery in good time.
- Replace the lithium battery only with batteries of the same type or a type recommended by SIEMENS.

The article number for the replacement part kit with lithium battery is A5E34345932.

NOTICE

Batteries and rechargeables pollute the environment

Do not dispose of used batteries or rechargeables in household waste. Users are obliged by law to return used batteries and rechargeable batteries. You as the user are legally responsible disposing used batteries or rechargeables in a correct manner.

Observe the following rules for the disposal of batteries and rechargeables:

- Dispose of used batteries and rechargeable batteries separately as hazardous waste in accordance with local regulations.
- You can take used batteries and rechargeable batteries to public collection points and wherever batteries and rechargeable batteries of the type in question are sold.
- Mark used battery containers as "Used batteries".

Limitation of liability

All technical specifications and approvals for the device apply only if you use expansion components that have a valid CE approval (CE marking). The installation instructions for expansion components in the associated documentation must be observed.

UL approval of the device only applies when the UL-approved components are used according to their "Conditions of Acceptability".

We are not liable for functional limitations caused by the use of third-party devices or components.

See also

Spare parts and repairs (<http://support.automation.siemens.com/WW/view/en/16611927>)

7.3 Cleaning the Device Front

The device is designed for low-maintenance operation. You should still clean the device front regularly, however.

CAUTION

Unwanted reactions when cleaning the device

You risk unintentional actuation of control elements if you clean the device while it is switched on.

You may possibly trigger unwanted actions of the device or controller that are liable to cause personal injury or damage to the machinery.

Always switch off the device before you clean it.

Cleaning Agents

NOTICE

Damage to the HMI device caused by impermissible cleaning agents

Impermissible and unsuitable cleaning agents may cause damage to the HMI device.

Use dish soap or foaming screen cleaner only as cleaning agents. Do not use the following cleaning agents:

- Aggressive solvents or scouring powder
- Steam jets
- Compressed air

Procedure

1. Switch off the device.
2. Dampen the cleaning cloth.
3. Spray the cleaning agent on the cloth and not directly on the device.
4. Clean the device with the cleaning cloth.

7.4 Installing and removing hardware

7.4.1 Replacing the backup battery

Requirements

- The device is disconnected from the power supply.
- The device is open, see the section "Open the device. (Page 79)".
- Replacement battery

Procedure

Removal

NOTICE
Time setting is lost The time and the setup settings are deleted if it takes longer than 30 seconds to replace the battery. The device time may no longer be synchronized. Time-controlled programs will no longer run or will run at the wrong time. This may damage the plant. Set the device time again.

Note

Writing down the BIOS settings

Make a note of the current BIOS setup settings or save them as a user profile in the BIOS setup Exit menu. You will find a list for noting the settings in the BIOS description.

1. Remove the marked battery connector.
2. Grip the marked battery and pull it up and out of its holder.



Installation

For installation, follow the removal steps in reverse order and close the device.

See also

General safety instructions (Page 19)

Repair information (Page 87)

7.4.2 Replacing the SSD

Requirement

- The device is disconnected from the power supply.
- The device is open, see the section "Open the device. (Page 79)".
- T10 screwdriver

Procedure

Removal

1. Remove the marked screws.
2. Remove the SSD from the mounting plate.
To do this, remove the screws that connect the SSD to the mounting plate.
3. Pull out the connector from the interface.



Installation

Note

Screws in various lengths

This procedure involves screws of various lengths:

- Screws to fasten the SSD to the hard disk holder (short screws)
- Screws to fasten the hard disk holder to the device (long screws)

Make sure you use the correct screws for each operation.

For installation, follow the removal steps in reverse order and close the device again.

See also

Repair information (Page 87)

7.4.3 Replacing HDD

This chapter applies to devices with hard disk drive.

Requirement

- The device is disconnected from the power supply.
- The device is open, see the section "Open the device. (Page 79)".
- T10 screwdriver

Procedure

Removal

1. Remove the marked screws.
2. Carefully remove the base plate with the hard disk fastened to it.
3. Remove the connector in the direction of the arrow.



4. Detach the hard disk from the base plate. Remove the four screws that connect the hard disk and the base plate.

Installation

Note

Screws in various lengths

This procedure involves screws of various lengths:

- Screws to fasten the SSD to the hard disk holder (short screws)
- Screws to fasten the hard disk holder to the device (long screws)

Make sure you use the correct screws for each operation.

For installation, follow these steps in reverse and close the device.

7.5 Installing the software

7.5.1 Reinstalling the operating system

Note

Further information on the delivered operating system can be found on the USB stick provided.

See also

Windows® 7 operating instructions on the supplied USB stick
(<https://support.industry.siemens.com/cs/ww/de/view/109749497/en>)

Windows® 10 operating instructions on the supplied USB stick
(<https://support.industry.siemens.com/cs/ww/de/view/109749498/en>)

7.5.1.1 General installation procedure

If your operating system is no longer functioning correctly, you can reinstall it from the supplied USB stick:

- With the recovery function of the supplied USB stick
- With the restore function of the supplied USB stick

For these functions, set up the USB stick as bootable. For this purpose, "USB Boot" must be set to "enabled" in the BIOS Setup.

Note

Installing the operating system in UEFI mode

To install an operating system in UEFI mode, the USB stick must also be booted in UEFI mode. Since Windows Embedded operating systems are installed in MBR mode, the USB stick boots automatically for the Restore function in MBR mode (Legacy mode).

GPT partitioning with Windows 10

Please note that GPT partitioning should be selected for Windows 10 (GPT: GUID Partition Table).

Recovery function (only with Windows 7 Ultimate and Windows 10)

NOTICE
Windows Embedded
The Recovery function is not available for Windows Embedded operating systems.

The supplied USB contains the installation program with tools for configuring the drives and installing the operating system with the supported languages.

The basic language of the installed operating system is English. To add other languages, install these languages from the supplied USB stick (Documentation and Drivers).

Contents of the "DocuAndDrivers" directory

The supplied USB stick contains the documentation, hardware drivers and updates.

In Windows, these contents are available via a menu.

Restore function

If you have ordered IPC477E with operating system, the supplied USB stick contains the Restore function.

Information on your operating system can be found on the Internet:

- Microsoft® Windows® 7
(<https://support.industry.siemens.com/cs/ww/de/view/109749497/en?dl=en>)
- Microsoft® Windows Embedded Standard® 7
(<https://support.industry.siemens.com/cs/ww/de/view/109749499/en?dl=en>)
- Microsoft® Windows® 10
(<https://support.industry.siemens.com/cs/ww/de/view/109749498/en?dl=en>)

7.5.1.2 Restoring the delivery state

You can restore the original factory software using the Restore function. The USB stick contains the necessary images and tools for transferring the factory software to the hard disk/SSD or memory card of your PC. The following options are available for restoring software:

- Restore the entire hard disk / SSD or memory card with drive C: (system) and drive D: Use the "Restore entire hard disk" option.
- Restore drive C: only This allows you to retain any user data on drive D: Use the "Restore system partition only" option.

NOTICE

Data are deleted

When you select the "Restore entire hard disk" option, all data, user settings and authorizations or license keys on the hard disk are lost. The hard disk is reset to the delivery state with partitions "C:" and "D:".

If the "Restore system partition only" option is set, all files on drive C: (System) are deleted. All data, user settings and existing authorizations or license keys on drive "C:" will be lost. Drive "C:" on the hard drive is completely erased, reformatted and the original software is written to it.

Procedure

Note

The "USB Boot" option has to be set to "Enabled" in the BIOS menu "Boot" so that the device can boot from the USB stick.

1. Connect the USB stick to the device.
2. Restart the device.
3. Press <ESC> when the following BIOS message appears:

Press Esc for Boot Options

The BIOS selection menu is displayed when initialization is completed.

4. To boot from the USB stick, select the Boot Manager.
5. Select the USB stick in the Boot Manager and confirm the entry.
6. Select the Restore function and confirm the entry.
7. Follow the on-screen instructions.

7.5.1.3 Windows 7 / Windows 10

Installing Windows

Note

Windows 10

Specific information on using the Windows operating systems is available in the following manuals (not included in the scope of delivery):

- Windows 10 - Step by Step (MS Press No. 324)
- Windows 10 Plain and Simple (MS Press No. 422)
- Windows 10 Inside Out (MS Press No. 325 / MS Press No. 418)

Windows 7

Specific information on using the Windows operating systems is available in the following manual (not included in the product package):

Microsoft Windows 7 - Technical Reference (MS Press No. 5927).

Requirement

- USB keyboard and monitor
- Supplied USB stick with Recovery function

Procedure

Note

The "USB Boot" option has to be set to "Enabled" in the BIOS menu "Boot" so that the device can boot from the USB stick.

1. Connect the USB stick to the device.
2. Restart the device.
3. Press <ESC> when the following BIOS message appears:

`Press Esc for Boot Options`

The BIOS selection menu is displayed when initialization is completed.

4. To boot from the USB stick, select the Boot Manager.
5. Select the USB stick in the Boot Manager and confirm the entry.
6. Select the Recovery function and confirm the entry.

7. Follow the on-screen instructions.

After a few seconds, you will see the "Install Windows" installation program.

NOTICE
Data deleted All data, user settings and existing authorizations or license keys are deleted during the installation of Windows 7 and Windows 10. <ul style="list-style-type: none">• Back up all data.• Check the data and time in the BIOS setup, "Main" menu and correct the displayed time if necessary.

8. Now follow the instructions of the installation program "Install Windows". You will find additional information in the operating system manual.

"Install Windows" installation program

The language of the installation program and the operating system you want to install has been preset to English. You can change the language of the operating system after the installation. You can find information on this in section: "Setting up the language selection by means of the Multilanguage User Interface (MUI) (Page 101)".

Setting up partitions under Windows

You can set up partitions during the installation process.

The recommended minimum size for Windows system partition varies, depending on the amount of RAM and additional software that you are going to use. Information about the partitioning of the data volume in the delivery state is available in section Setting up the partitions under Windows 7 Ultimate and Windows 10 (Page 106).

Setting up the language selection by means of the Multilanguage User Interface (MUI)

You can set the display of menus, dialogs or other information, such as date and time, to a different language. For this purpose, you can either select one of the preinstalled languages or install a new language package.

The following command sequences are described in English. Depending on the default setting, they can be displayed in another language.

Setting up language selection

Changing the settings for language, region and formats of a registered user account

1. Choose:

"Start > Control Panel > Clock, Language, and Region > Regional and Language Options"

2. You can make the desired changes in the "Formats", "Location" and "Keyboards and Languages" tabs.

Changing the settings for language, region and formats of the system account and the standard user account

You can change the settings for language, region and formats of the system account (for example, the language in the user login dialog) and the settings of the standard user account (standard setting for new users). The settings of the registered user are copied to the system account and the standard user account for this purpose.

1. Choose:
"Start > Control Panel > Clock, Language, and Region > Regional and Language Options"
2. You can make the required changes in the "Administrative" tab. You copy the settings by clicking the respective button.

Installing new language packages

Some language packages are available on the Recovery section of the USB stick in the "Language packs" folder.

1. Choose:
"Start > Control Panel > Clock, Language, and Region > Regional and Language Options"
2. Select the "Keyboards and Languages" tab.
3. Click the "Install/uninstall languages" button and make the required changes.

See also

Windows® 7 operating instructions on the supplied USB stick
(<https://support.industry.siemens.com/cs/ww/de/view/109749497/en>)

Windows® 10 operating instructions on the supplied USB stick
(<https://support.industry.siemens.com/cs/ww/de/view/109749498/en>)

7.5.1.4 Windows Embedded Standard

General installation procedure

If your software becomes corrupt for any reason, you can reinstall it using the supplied USB stick. The USB stick contains an image file for the device memory with the original software package (operating system with installed hardware drivers).

Note

You require a USB keyboard and the supplied USB stick to reinstall the operating system. Before performing the new installation, you should check the date and time set in the BIOS Setup, "Main" menu, and correct these if necessary.

To be able to use the Enhanced Write Filter (EWF), the operating system must be installed in MBR mode.

Language selection in Windows Embedded Standard 7

You can change the language using the supplied USB stick. The USB stick contains the required language packages and help for changing the system language.

Note**Note the license terms of Windows Embedded Standard 7**

Note the license terms for Windows Embedded Standard 7 and especially the extended software terms of the Siemens AG.

You can find the license terms in the delivered document "MICROSOFT SOFTWARE LICENSE TERMS for Windows Embedded Standard 7" and in the system drive under \Windows\System32\license.rtf.

Procedure - Change system language

1. Connect the supplied USB stick to a free USB port of the device.
2. Restart the device and press "ESC" to access the BIOS.
3. Switch to the "Boot" menu and select the setting "USB Boot" = "Enabled".
4. Switch to the "Exit" menu and select "Exit Saving Changes".
5. Restart the device and press the "ESC" key and then enter the "Boot Manager" menu.
6. Select the USB stick and press "Enter" to boot from this.

7.5 Installing the software

7. Follow the instructions on the screen.
8. After selecting the menu dialog language, select the menu entry "Manage language packages".

Depending on the current language setup, you have the following options in the "Manage language packages" menu:

- Display language settings
- Install language
- Change language
- Uninstall installed language

7.5.2 Partitioning data media

7.5.2.1 Partitioning in Windows Embedded Standard 7

You will need to reconfigure the partitions after installing a new drive, to repair corrupt partitions or to change the partitioning.

Partitioning of the SIMATIC IPC CFast card

The SIMATIC IPC CFast card for Windows Embedded Standard 7 comes configured with the following default partitions:

Table 7- 1 32-bit versions of the operating system

Partition	Name	Size of the card			File system
		8 GB	16 GB	30 GB	
First	SYSTEM	6 GB	12 GB	25 GB	NTFS (not compressed)
Second	DATA	Remainder	Remainder	Remainder	NTFS (not compressed)

* Due to partitioning/formatting, the actual CFast capacity does not correspond to the memory size specified on the SIMATIC IPC CFast card.

Table 7- 2 64-bit versions of the operating system

Partition	Name	Size of the card		File system
		16 GB	30 GB	
First	SYSTEM	13 GB	25 GB	NTFS (compressed)
Second	DATA	Remainder	Remainder	NTFS (compressed)

* Due to partitioning/formatting, the actual CFast capacity does not correspond to the memory size specified on the SIMATIC IPC CFast card.

Partitioning of the HDD or SSD

In the delivery state, the following partitions are configured on the HDD or SSD drive with the Windows Embedded Standard 7 operating system:

Partition	Name	Partition size		File system
		< 100 GB	> 100 GB	
Primary	System	60 GB	100 GB	NTFS not compressed
Second	Data	Remainder	Remainder	NTFS not compressed

To restore the partitions to their original delivery state, we recommend the software **SIMATIC IPC Image & Partition Creator**. Additional information is available in the accompanying documentation.

7.5.2.2 Setting up the partitions under Windows 7 Ultimate and Windows 10

You will need to reconfigure the partitions after installing a new drive, to repair corrupt partitions or to change the partitioning.

Partitioning of the HDD or SSD

In the factory state, the following partitions are set up on the HDD or SSD for the Windows 7 x64 UEFI operating system:

Partition	Name	Partition size		File system
		SSD: > 60 GB	SSD/HDD: > 100 GB	
First	Boot	260 MB		FAT32
Second	MSR	128 MB		None
Third	System	60 GB	100 GB	NTFS, not compressed
Fourth	Data	Remainder		NTFS, not compressed

In the factory state, the following partitions are set up on the HDD or SSD for the Windows 10 UEFI operating system:

Partition	Name	Partition size		File system
		SSD: > 60 GB	SSD/HDD: > 100 GB	
First	Boot	260 MB		FAT32
Second	MSR	128 MB		None
Third	System	60 GB	100 GB	NTFS, not compressed
Fourth	WinRE	500 MB		NTFS, not compressed
Fifth	Data	Remainder		NTFS, not compressed

7.5.2.3 Adapting partitions in Windows 7 Ultimate and Windows Embedded Standard 7

With the disk management, you can adapt the partitioning of your drives.

You can reduce or delete an available partition to acquire unassigned memory space, which you can use to set up a new partition or to increase an existing partition.

Note**Data lost in the case of deleting a partition!**

If you delete a partition, all the data on this partition is lost.

Back up your data before you change partitions.

Requirement

You are logged on as an administrator.

Procedure - Reduce partition

A partition can only be reduced if sufficient space is available.

1. Click with the right mouse button on the partition to be reduced and click on "Reduce size".
2. Follow the instructions.

Procedure - Increase partition

Note

To increase a partition, this partition must not be formatted with a file system or the partition must be formatted with an "NTFS" file system.

1. Click in the partition manager with the right mouse button on the partition to be increased and click on "Increase size".
2. Follow the instructions on the screen.

Additional information is available in the "Help" menu under "Help topics" and "Search".

7.5.3 Installing drivers and software

Note

In the case of multilingual operating systems (MUI versions), you must set the menus and dialogs and the default language to English (US) in the regional settings before new drivers and operating system updates are installed.

You can install a second language package for service purposes at a later time with the supplied USB stick under Windows Embedded Standard 7.

Procedure

1. Connect the supplied USB stick to the USB port.
2. Start the program "START_DocuAndDrivers".
3. Select "Drivers" in the index.
4. Select the device and operating system.
5. Select the required driver.
6. Open the folder with the driver data by clicking on the link next to "Driver path".
7. Start the setup program in this folder.

Note

For a new installation of Windows operating systems, the chipset driver must be installed before all other drivers, if required.

7.5.4 Update installation

7.5.4.1 Updating the operating system

Windows

The latest updates for the Windows operating system are available on the Internet at Microsoft (<http://www.microsoft.com/en-us>) and on the device in the Start menu "Start > All Programs > Windows Update > Check for updates".

Note

Before you install new drivers or operating system updates for Windows MUI versions, configure the regional menu and dialog settings and the default English (US) language.

other operating systems

Contact the corresponding manufacturer.

7.5.4.2 Installing or updating application programs and drivers

Drivers for USB sticks are included in the operating system and do not have to be installed separately.

For information about installation of SIMATIC software packages, refer to the corresponding manufacturer documentation.

For updates of third-party drivers and application programs, contact the respective manufacturer.

7.5.5 Backing up data

We recommend the software tool **SIMATIC IPC Image & Partition Creator** (as of V3.4) to back up data under Windows. This tool provides convenient and efficient functions for backing up and restoring the full content of memory cards, hard disks and individual partitions (images).

The **SIMATIC IPC Image & Partition Creator** can be ordered using the Siemens online ordering system (<https://mall.industry.siemens.com>). For more information about SIMATIC IPC Image & Partition Creator, refer to its product documentation.

7.6 Recycling and disposal

The devices described in these operating instructions can be recycled thanks to their low level of pollutants. Contact a certified disposal service company for environmentally sound recycling and disposal of your old devices.

Technical information

8.1 Certificates and approvals



The device meets the guidelines listed in the following sections.

EU Declaration of Conformity

The associated declaration of conformity is available on the Internet at the following address:

Panel PC certificates

(<http://support.automation.siemens.com/WW/view/en/10805572/134200>).

ISO 9001 certificate

The Siemens quality management system for our entire product creation process (development, production and sales) meets the requirements of ISO 9001:2008.

This has been certified by DQS (the German society for the certification of quality management systems).

Certificate no.: 001323 QM08

Software license agreements

If the device is supplied with preinstalled software, you must observe the corresponding license agreements.

UL approval



- Underwriters Laboratories (UL) in accordance with standard UL508 (IND.CONT.EQ), File E85972
- Canadian National Standard CAN/CSA-C22.2 No. 142

FCC (USA) and ICES (Canada) Compliance

USA	
Federal Communications Commission Radio Frequency Interference Statement	This equipment has been tested and found to comply with the limits for a Class A digital device, pursuant to Part 15 of the FCC Rules. These limits are designed to provide reasonable protection against harmful interference when the equipment is operated in a commercial environment. This equipment generates, uses, and can radiate radio frequency energy and, if not installed and used in accordance with the instruction manual, may cause harmful interference to radio communications. Operation of this equipment in a residential area is likely to cause harmful interference in which case the user will be required to correct the interference at his own expense.
Shielded Cables	Shielded cables must be used with this equipment to maintain compliance with FCC regulations.

8.1 Certificates and approvals

USA	
Modifications	Changes or modifications not expressly approved by the manufacturer could void the user's authority to operate the equipment.
Conditions of Operations	This device complies with Part 15 of the FCC Rules. Operation is subject to the following two conditions: (1) this device may not cause harmful interference, and (2) this device must accept any interference received, including interference that may cause undesired operation.

CANADA	
Canadian Notice	This Class A digital apparatus complies with Canadian ICES-003 (A).
Avis Canadien	Cet appareil numérique de la classe A est conforme à la norme NMB-003 (A) du Canada.

RCM AUSTRALIA/NEW ZEALAND



This product meets the requirements of EN 61000-6-4:2007 Generic standards - Emission standard for industrial environments.

This product meets the requirements of the standard EN 61000-6-4:2007 Generic standards – Emission standard for industrial environments.

KOREA



This product meets the requirements of Korean certification.

This product satisfies the requirement of the Korean Certification (KC Mark).

이 기기는 업무용(A급) 전자파 적합기기로서 판매자 또는 사용자는 이 점을 주의하시기 바라며 가정 외의 지역에서 사용하는 것을 목적으로 합니다.

8.2 Directives and declarations

8.2.1 Electromagnetic compatibility

Electromagnetic compatibility

This product meets the requirements of EU Directive 2014/30/EU "Electromagnetic Compatibility".

The device is designed for the following areas of application corresponding to the CE marking:

Scope of application	Requirements for	
	Interference emission	Immunity to interference
Industrial area	EN 61000-6-4	EN 61000-6-2

The devices with AC power supply comply with the standards EN 61000-3-2 (harmonic currents) and EN 61000-3-3 (voltage fluctuations and flicker).

RoHs directive

This product meets the requirements stated in the RoHS directive (Restriction of Hazardous Materials): 2011/65/EU

Compliance with the directive has been reviewed according to the following standard: EN 50581

Low-voltage directive

The device with AC power supply complies with the requirements of the EU Directive 2014/35/EU "Low Voltage Directive". Conformance with this standard has been verified according to EN 60950-1.

8.2.2 ESD guideline

What does ESD mean?

An electronic module is equipped with highly integrated components. Due to their design, electronic components are highly sensitive to overvoltage and thus to the discharge of static electricity. Such electronic components or modules are labeled as electrostatic sensitive devices.

The following abbreviations are commonly used for electrostatic sensitive devices:

- ESD – Electrostatic sensitive device
- ESD – Electrostatic Sensitive Device as a common international designation

Electrostatic sensitive devices can be labeled with an appropriate symbol.



NOTICE

Damage to ESD from touch

Electrostatic sensitive devices, ESD, can be destroyed by voltages which are far below the human perception limit. If you touch a component or electrical connections of a module without discharging any electrostatic energy, these voltages may arise.

The damage to a module by an overvoltage can often not be immediately detected and only becomes evident after an extended period of operation. The consequences are incalculable and range from unforeseeable malfunctions to a total failure of the machine or system.

Avoid touching components directly. Make sure that persons, the workstation and the packaging are properly grounded.

Charge

Every person without a conductive connection to the electrical potential of his/her surroundings can be electrostatically charged.

The material with which this person comes into contact is of particular significance. The figure shows the maximum electrostatic voltages with which a person is charged, depending on humidity and material. These values conform to the specifications of IEC 61000-4-2.

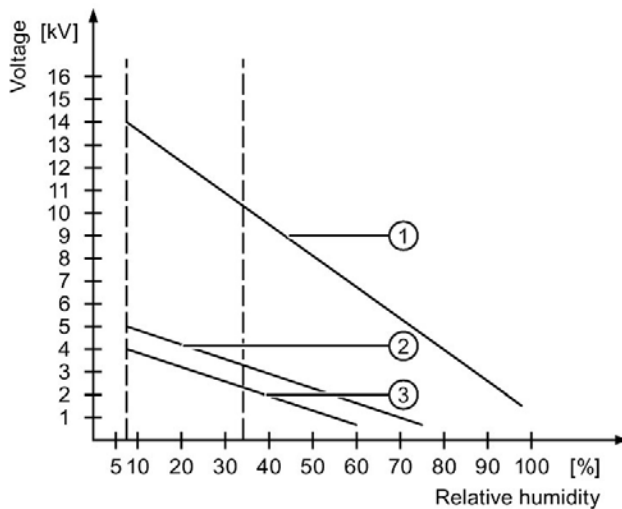

- ① Synthetic materials
- ② Wool
- ③ Antistatic materials such as wood or concrete

NOTICE

Grounding measures

There is no equipotential bonding without grounding. An electrostatic charge is not discharged and may damage the ESD.

Protect yourself against discharge of static electricity. When working with electrostatic sensitive devices, make sure that the person and the workplace are properly grounded.

Protective measures against discharge of static electricity

- Disconnect the power supply before you install or remove modules which are sensitive to ESD.
- Pay attention to good grounding:
 - When handling electrostatic sensitive devices, make sure that persons, the workstation and devices, tools and packaging used are properly grounded. This way you avoid static discharge.
- Avoid direct contact:
 - As a general rule, do not touch electrostatic sensitive devices, except in the case of unavoidable maintenance work.
 - Hold the modules at their edge so that you do not touch the connector pins or conductor paths. This way, the discharge energy does not reach and damage the sensitive components.
 - Discharge your body electrostatically before you take a measurement at a module. Do so by touching grounded metallic parts. Always use grounded measuring instruments.

8.3 Dimension drawings

8.3.1 Dimension drawing of 15" device with capacitive multi-touch screen

The figure shows the front view and directly associated side view and top view of a device without PCI expansion. The side view and top view of a device with PCI expansion are shown beyond at a distance.

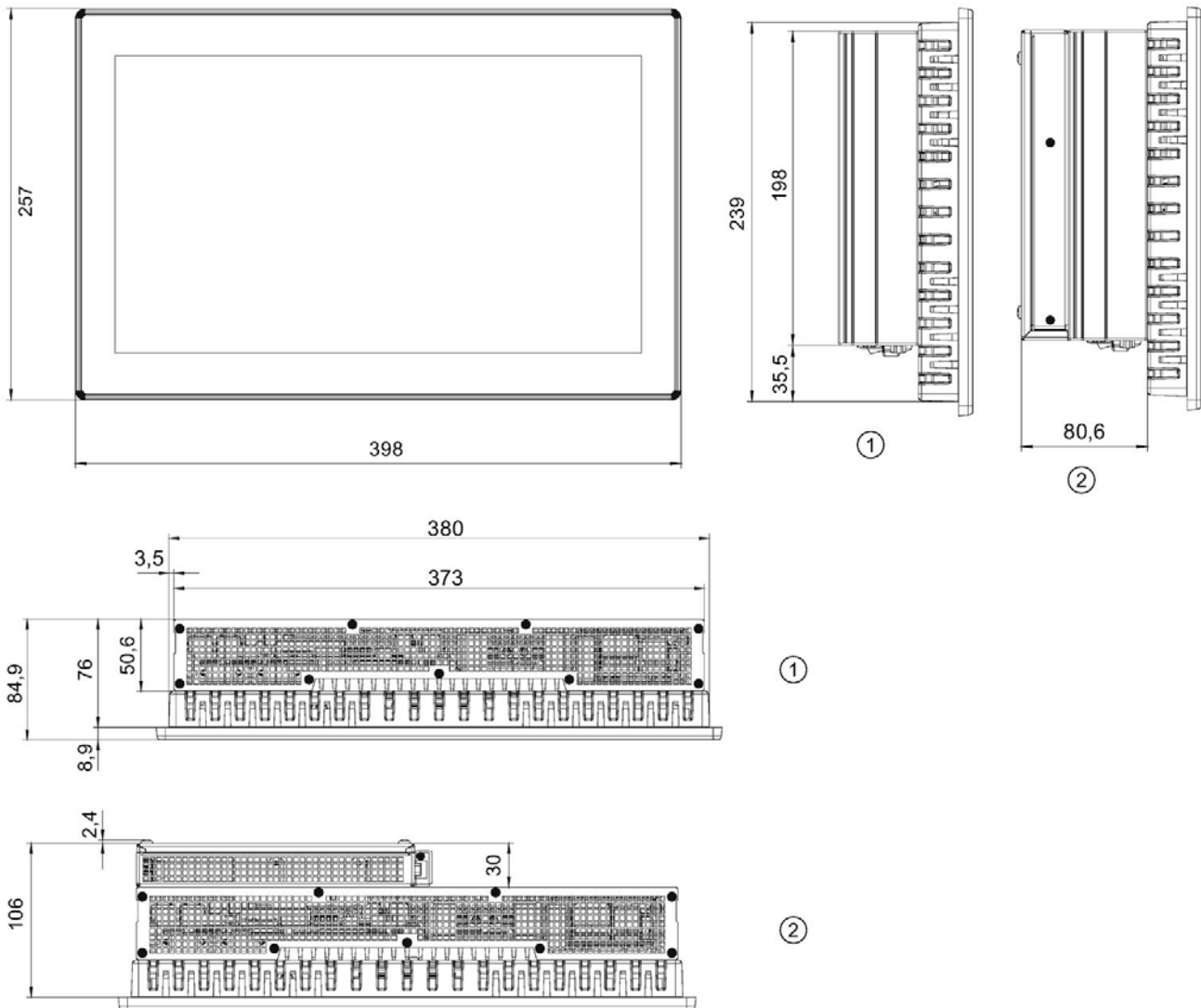

- 1 Device without PCI expansion
- 2 Device with PCI expansion

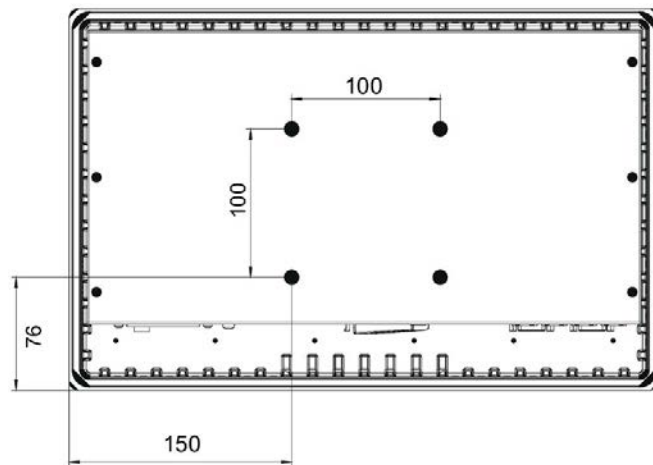

All dimensions in mm.

Device depths

- Without expansion cards: 75.5 mm
- With PCIe card: 102.5 mm

8.3.2 Dimension drawing of 19" device with capacitive multi-touch screen

The figure shows the front view and directly associated side view and top view of a device without PCI expansion. The side view and top view of a device with PCI expansion are shown beyond at a distance.

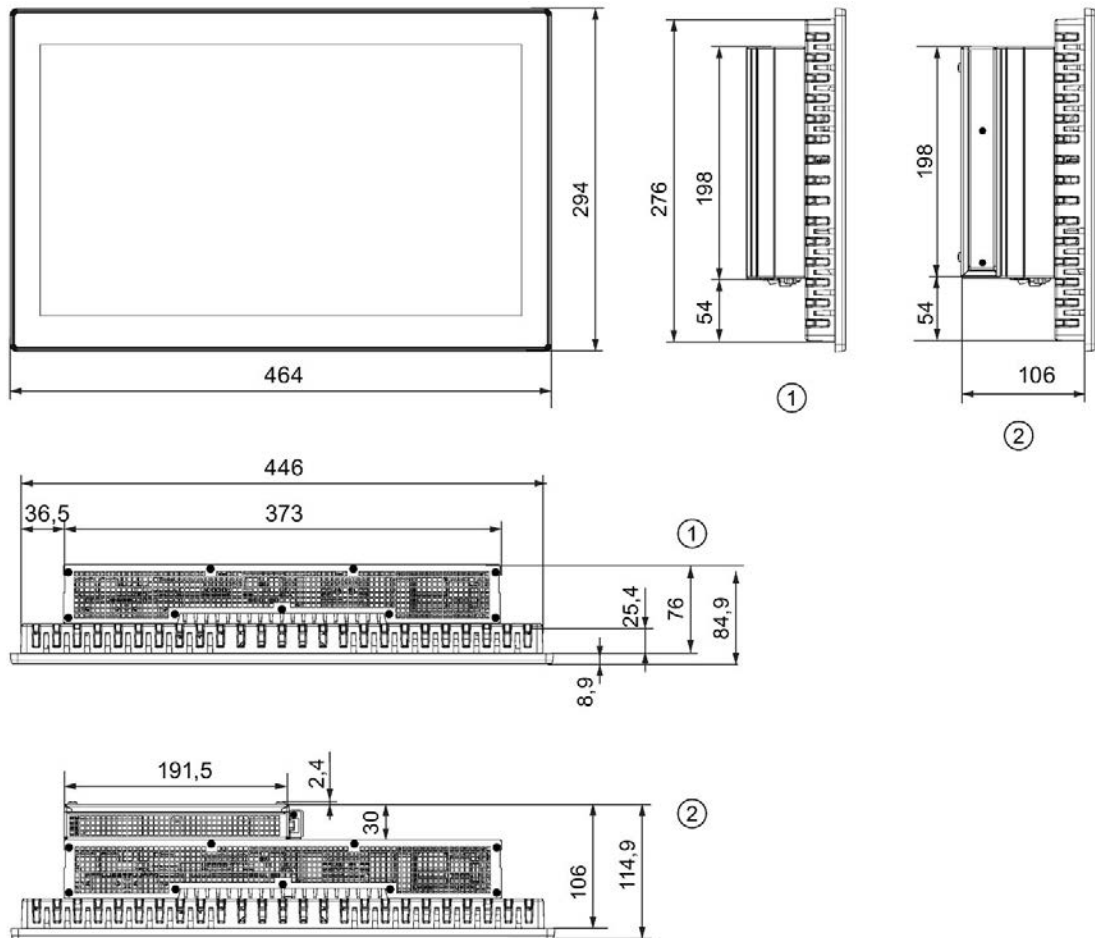

- 1 Device without PCI expansion
- 2 Device with PCI expansion

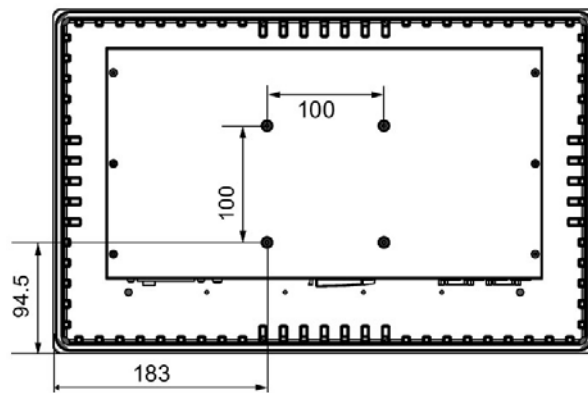

All dimensions in mm.

Device depths

- Without expansion cards: 75.5 mm
- With PCIe card: 102.5 mm

8.3.3 Dimension drawing of 22" device with capacitive multi-touch screen

The figure shows the front view and directly associated side view and top view of a device without PCI expansion. The side view and top view of a device with PCI expansion are shown beyond at a distance.

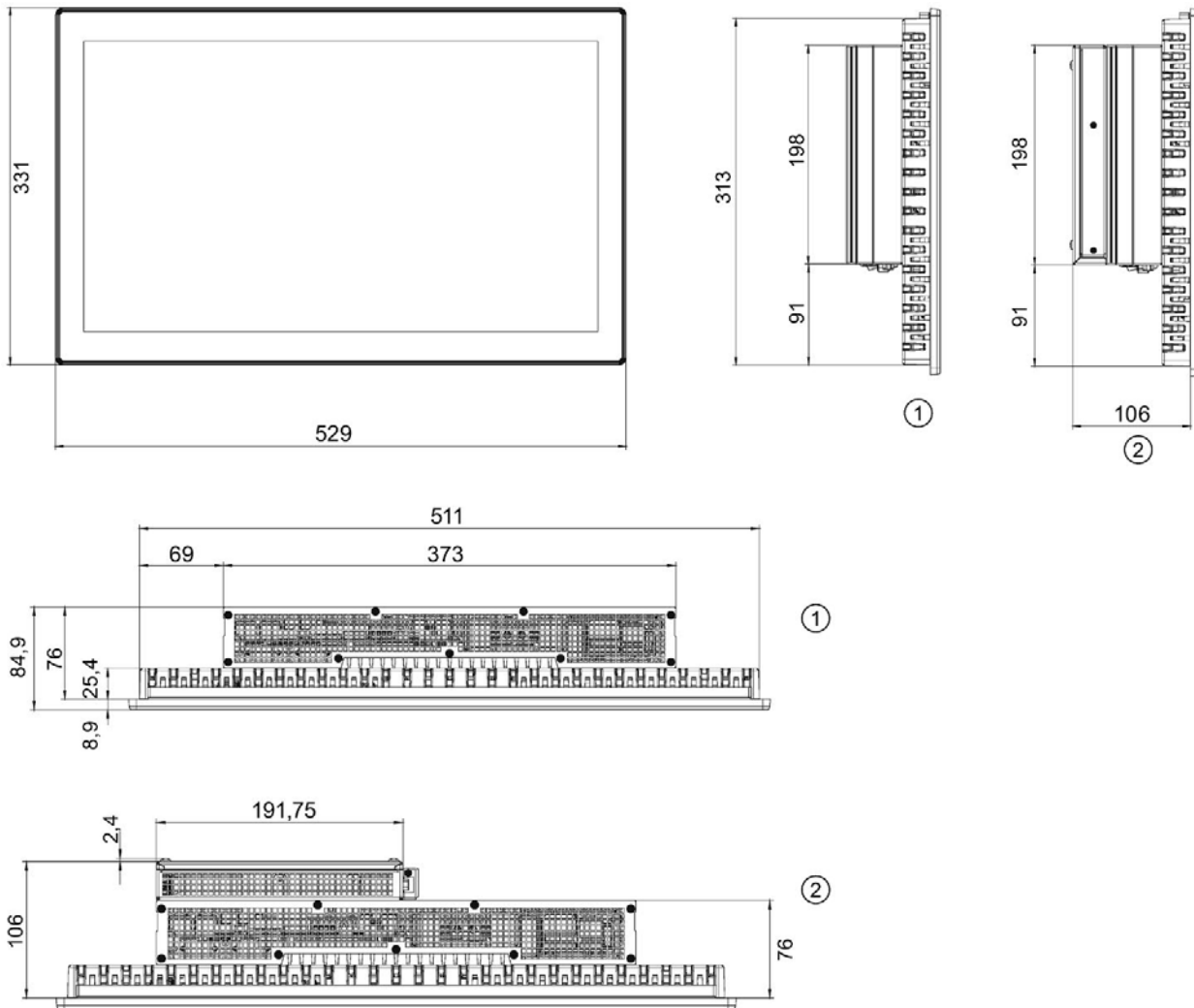

- 1 Device without PCI expansion
- 2 Device with PCI expansion

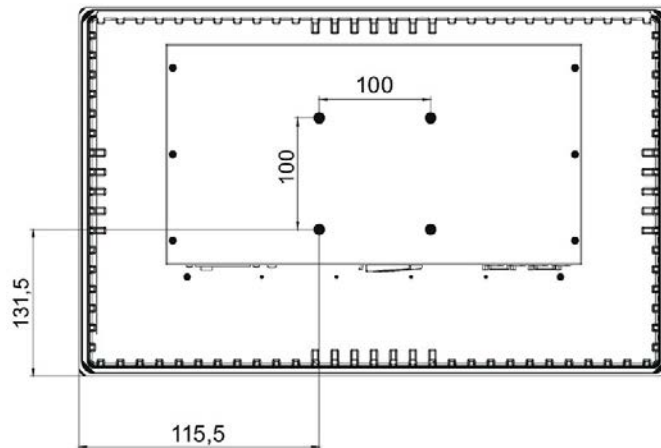

All dimensions in mm.

Device depths

- Without expansion cards: 75.4 mm
- With PCIe card: 102.5 mm

8.3.4 Dimension drawing of 24" device with capacitive multi-touch screen

The figure shows the front view and directly associated side view and top view of a device without PCI expansion. The side view and top view of a device with PCI expansion are shown beyond at a distance.

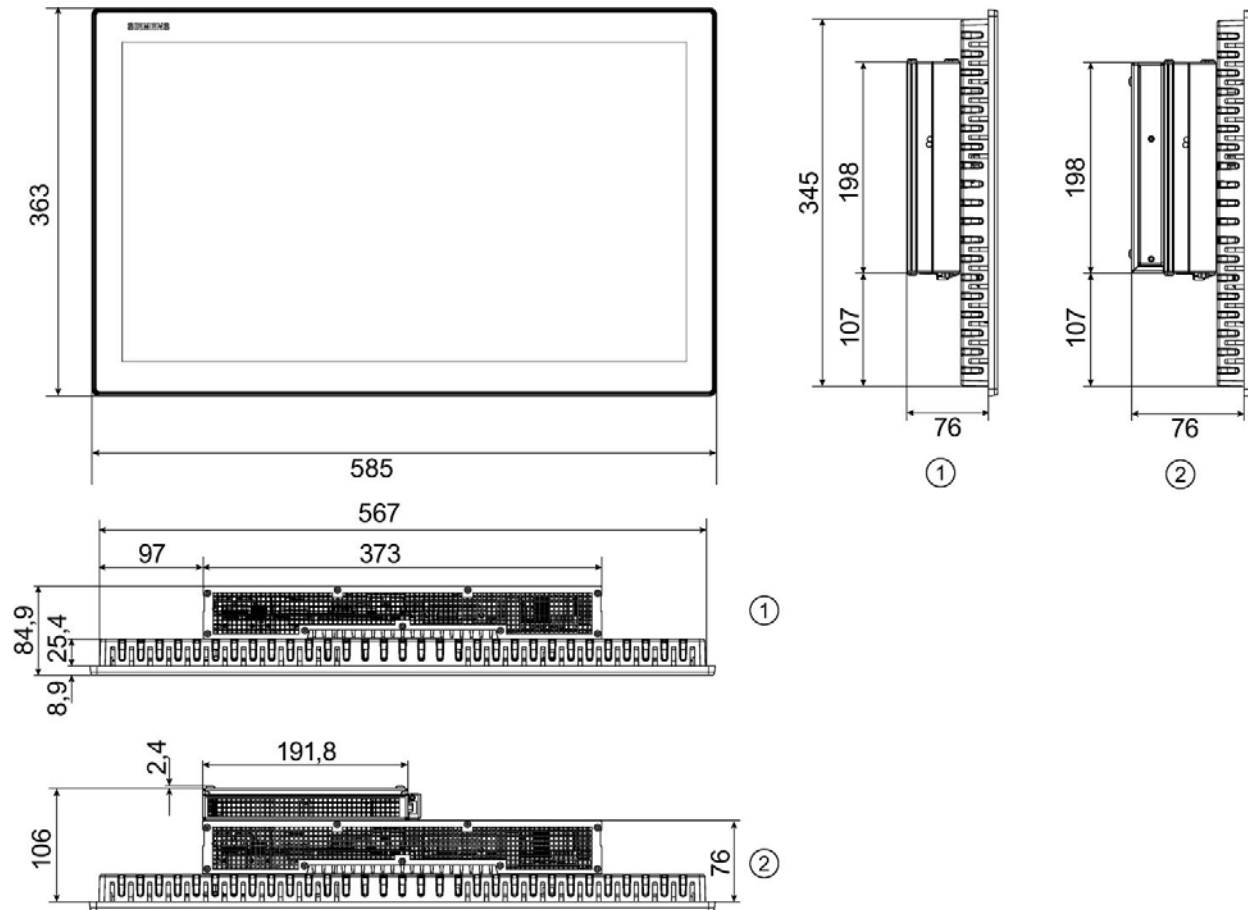

- 1 Device without PCI expansion
- 2 Device with PCI expansion

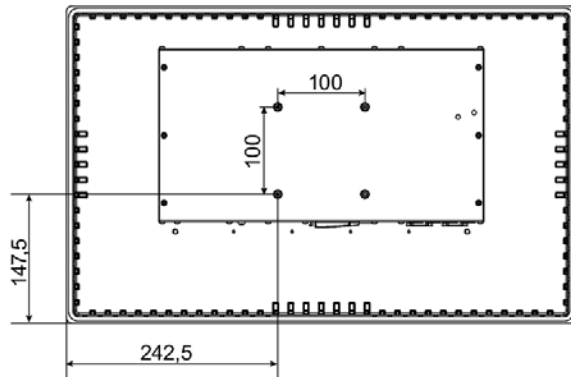

All dimensions in mm.

Device depths

- Without expansion cards: 75.4 mm
- With PCIe card: 102.5 mm

8.3.5 Dimension drawing of 15" device with resistive single-touch screen

The figure shows the front view and directly associated side view and top view of a device without PCI expansion. The side view and top view of a device with PCI expansion are shown beyond at a distance.

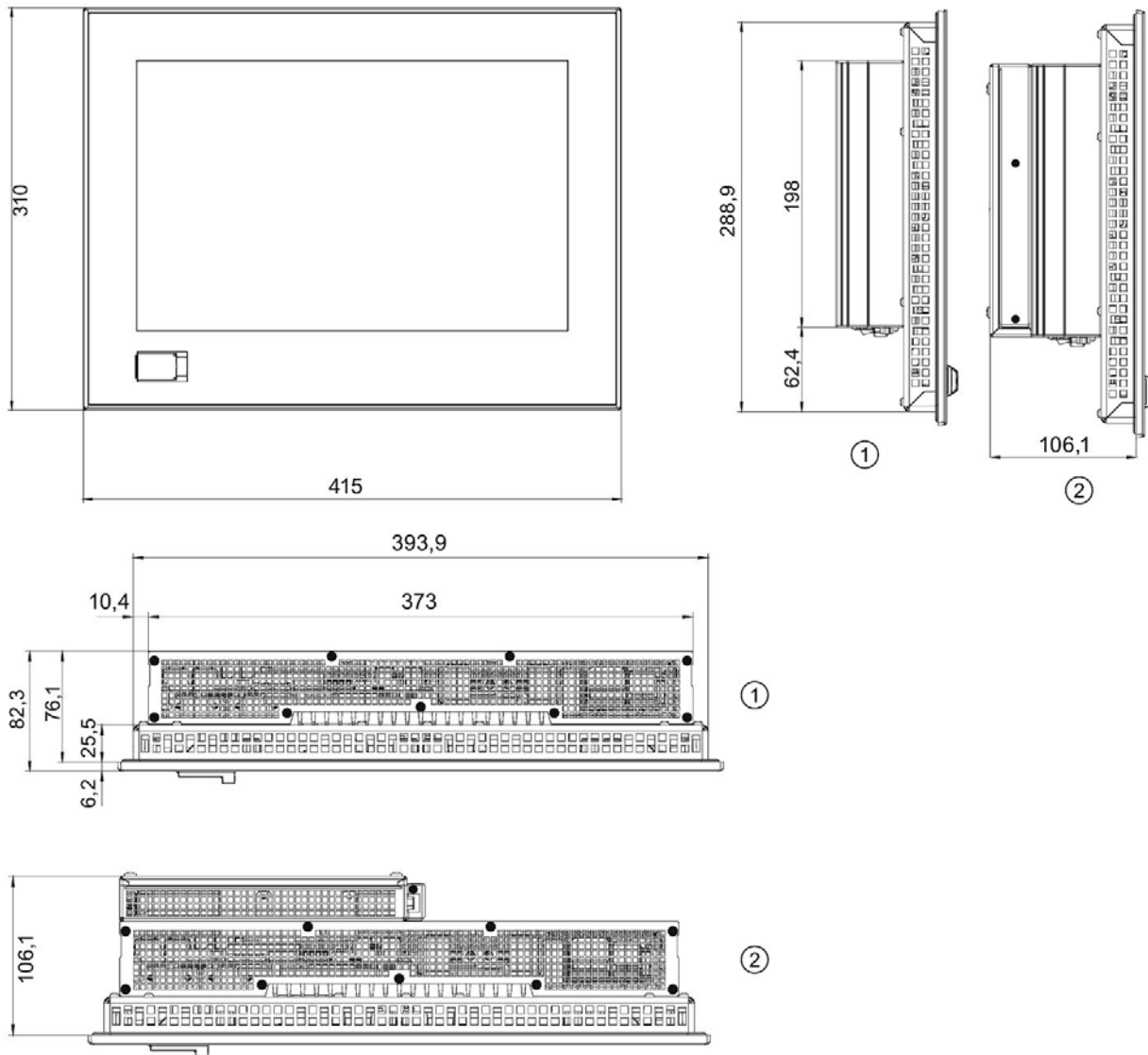

- 1 Device without PCI expansion
- 2 Device with PCI expansion

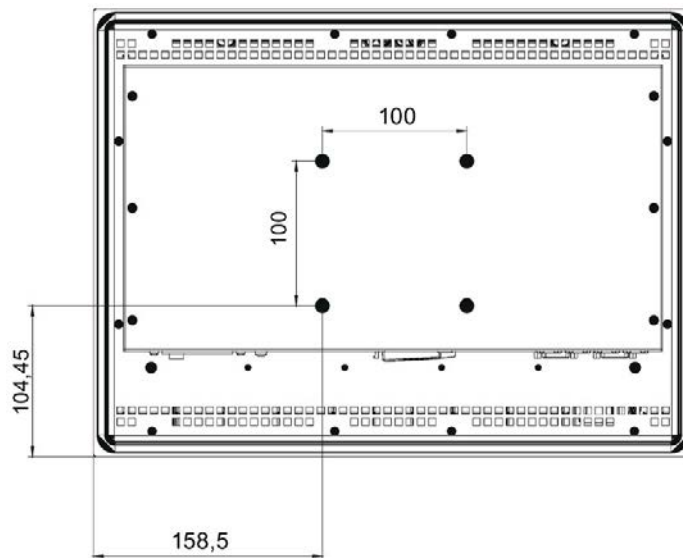

All dimensions in mm.

Device depths

- Without expansion cards: 75.5 mm
- With PCIe card: 106.1 mm

8.3.6 Dimension drawing of 19" device with resistive single-touch screen

The figure shows the front view and directly associated side view and top view of a device without PCI expansion. The side view and top view of a device with PCI expansion are shown beyond at a distance.

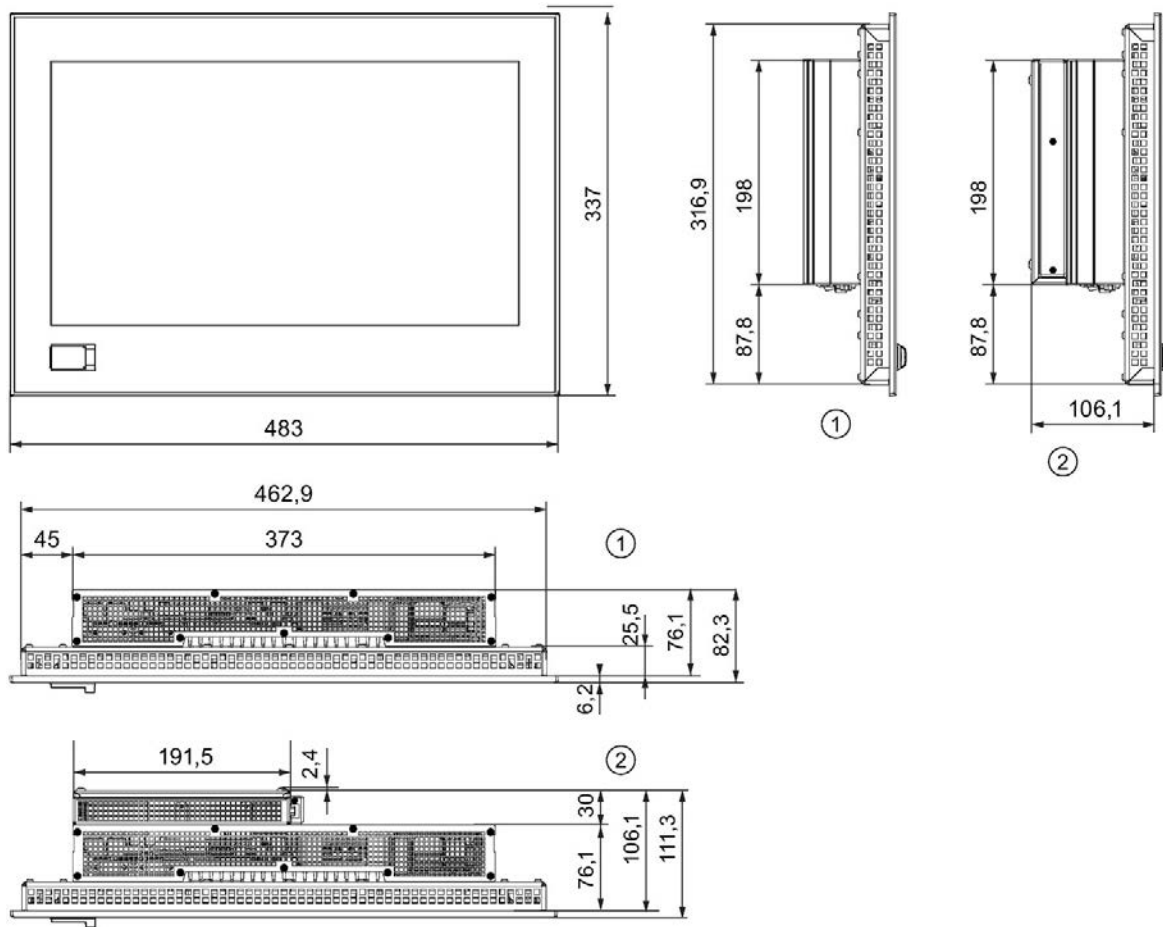

- 1 Device without PCI expansion
- 2 Device with PCI expansion

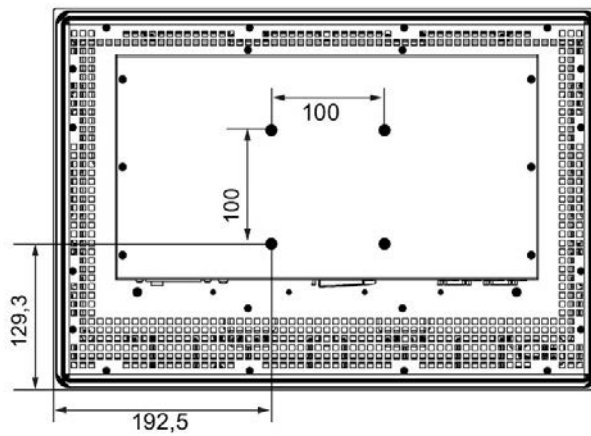

All dimensions in mm.

Device depths

- Without expansion cards: 76.1 mm
- With PCIe card: 106.1 mm

8.3.7 Dimension drawing of 22" device with resistive single-touch screen

The figure shows the front view and directly associated side view and top view of a device without PCI expansion. The side view and top view of a device with PCI expansion are shown beyond at a distance.

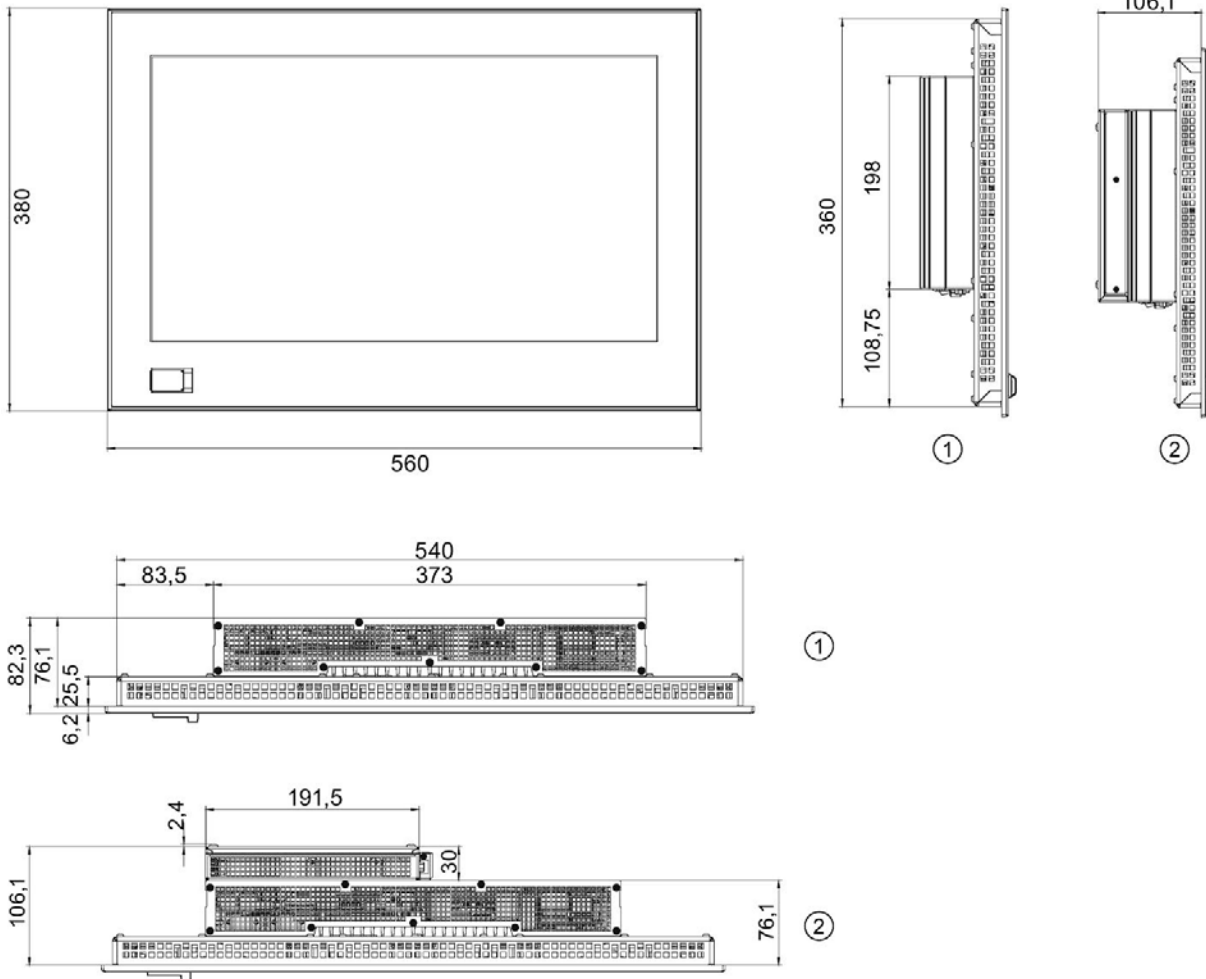

- 1 Device without PCI expansion
- 2 Device with PCI expansion

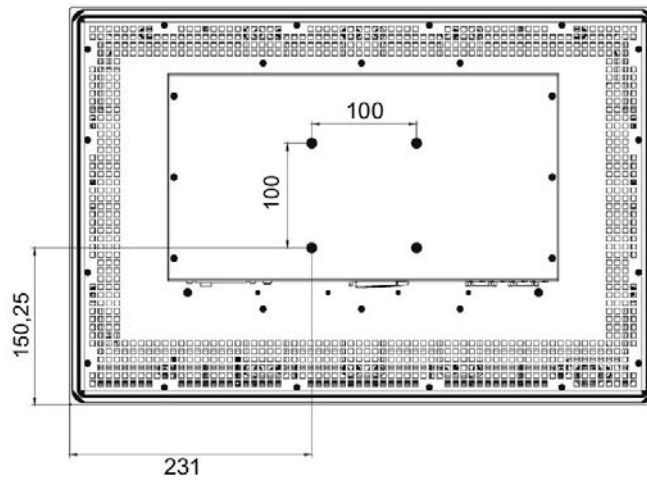

All dimensions in mm.

Device depths

- Without expansion cards: 75.5 mm
- With PCIe card: 106.1 mm

8.4 Technical specifications

8.4.1 General technical specifications

Weight of touch device (without expansions): <ul style="list-style-type: none"> • Touch screen device, 15" display • Touch screen device, 19" display • Touch screen device, 22" display • Touch screen device, 24" display 	Resistive touch screen <ul style="list-style-type: none"> • Approximately 6800 g • Approximately 8400 g • Approximately 9400 g • --- 	Capacitive touch screen <ul style="list-style-type: none"> • Approximately 5200 g • Approximately 6700 g • Approximately 7900 g • Approx. 9000 g
For device with expansion cards, the weight increases accordingly: <ul style="list-style-type: none"> • Expansion: PCIe card 	<ul style="list-style-type: none"> • Approximately 150 g 	
Power supply ¹	<ul style="list-style-type: none"> • 24 V DC (-20 % / +20 %) ¹ • 100-240 VAC (-15 % / +20 %); 50-60 Hz 	
Short-term voltage interruption according to Namur	Min. 20 ms (DC) Min. 20 ms (AC); max. 10 events per hour; min. 1 s recovery time	
Degree of protection	<ul style="list-style-type: none"> • IP 20 to IEC 60529 (enclosure) • IP 65 (front) 	
Quality assurance	In accordance with ISO 9001	

¹ The device should only be connected to a 24 VDC power supply which meets the requirements of safe extra low voltage (SELV) according to IEC/EN/DIN EN/UL 60950-1. The supplying source must be fused for a power rating < 240 VA; recommended fuse rating ≤ 8 A.

Power consumption (DC)

The table below shows the maximum power consumption of the devices with and without expansion.

Device type	Without expansion	With PCIe
15" Touch	70 W	77 W
19" Touch	78 W	85 W
22" Touch	75 W	82 W
24" Touch	75 W	82 W

Electromagnetic compatibility

Interference emission	EN 61000-6-4; CISPR 22 Class A; FCC Class A
Immunity with regard to conducted interference on the supply lines	± 2 kV according to IEC 61000-4-4; burst ± 1 kV according to IEC 61000-4-5; symmetrical surge ± 2 kV according to IEC 61000-4-5; asymmetrical surge
Noise immunity on signal lines	± 2 kV according to IEC 61000-4-4; Burst; Length > 3 m ± 1 kV according to IEC 61000-4-4; Burst; length < 3 m ± 2 kV according to IEC 61000-4-5; Surge, symmetric, length > 30 m
Immunity to electrostatic discharge	± 6 kV contact discharge in accordance with IEC 61000-4-2 ± 8 kV air discharge in accordance with IEC 61000-4-2
Immunity to RF interference	10 V/m, 80 to 2000 MHz 80% AM according to IEC 61000-4-3 3 V/m, 2 to 2.7 GHz 10 V, 10 kHz to 80 MHz according to IEC 61000-4-6
Immunity to magnetic fields	100 A/m, 50/60 Hz according to IEC 61000-4-8

Motherboard

Depending on the device variants, the device features the following components:

Processor	<ul style="list-style-type: none"> • Intel® Celeron® Processor G3902E (2 MB cache, 1.6 GHz) • Intel® Core™ i3-6102E Processor (3 MB cache, 1.9 GHz) • Intel® Core™ i5-6442EQ Processor (6 MB cache, up to 2.7 GHz) • Intel® Xeon® Processor E3-1505L v5 (8 MB cache, up to 2.8 GHz)
Main memory	<p>Memory modules without ECC:</p> <ul style="list-style-type: none"> • 4 GB DDR4-SDRAM SODIMM • 8 GB DDR4-SDRAM SODIMM • 16 GB DDR4-SDRAM SODIMM <p>Memory module with ECC (not combinable with i5 CPU):</p> <ul style="list-style-type: none"> • 8 GB DDR4-SDRAM SODIMM • 16 GB DDR4 SDRAM SODIMM
Backup memory ¹	512 kB NVRAM optional

¹ For devices with retentivity

Drive and memory media

Depending on the device variants, the device features the following components:

SATA drive	1 slot
Solid State Drive	2.5", ≥ 80 GB, SATA
Hard disk drive, HDD	2.5", ≥ 320 GB, SATA
CFast card	<ul style="list-style-type: none"> • 2 GB optional or • 4 GB optional or • 8 GB optional or • 16 GB optional or • 30 GB optional

Display

	15" (MT)	15" ¹	19"	22"	24" (MT)
Display type	LCD TFT with extended viewing angle	LCD TFT with extended viewing angle	LCD TFT	LCD TFT with extended viewing angle	LCD TFT with extended viewing angle
Active display area	344 x 194 mm	331 x 207 mm	410 x 230 mm	475 x 267 mm	527 x 296.5 mm
Resolution	1366 x 768 pixels	1280 x 800 pixels	1366 x 768 pixels	1920 x 1080 pixels	1920 x 1080 pixels
Possible colors	Up to 16.7 million				
Brightness control	Yes, from 0 to 99 ² , 0 = backlight off				
Backlighting	LED	LED	LED	LED	LED
Half Brightness Life Time (MTBF ^{2 3})	50000 h	50000 h	50000 h	30000 h	30000 h
Pixel error class in accordance with ISO 9241-307	II				
Touch force resistive touch screen	With test pen, 2 mm diameter: 5 N				
Graphics					
Graphics controller	Intel® HD Graphics 510 / 530 / P530 (depending on CPU type)				
Graphics memory	32 to 512 MB shared memory				
External interfaces	DP (DisplayPort): 1920 × 1200, 60 Hz				

¹ with resistive touch screen only

² Via SetBrightness dialog: 9 to 99 (± 10 to 100%),
via SetBrightness command line call: 0 to 99

³ MTBF: Operating hours after which the maximum brightness is reduced by half compared to the original value. MTBF is increased by using the integrated dimming function, for example, time-controlled via screen saver or centrally via PROFlenergy.

Interfaces

COM 1, COM 2 (optional)	RS232/RS422/RS485, max. 115 kbps, 9-pin, D-Sub pin
2 x DisplayPort (DPP)	Connection of display devices with DisplayPort connection
Keyboard	Connection via USB port
Mouse	Connection via USB port
USB	Back of device: <ul style="list-style-type: none"> • 4 x USB 3.0, a maximum of 2 can be operated in high-current mode at the same time Front of device (only for devices with resistive touch screen with 15", 19" and 22" display): <ul style="list-style-type: none"> • 1 x USB 3.0, high current
Ethernet ¹	3 x RJ45 connection, Intel 1 x I219LM, 2 x I210 10/100/1000 Mbps, electrically isolated, teaming-capable ²
Slot for PCIe expansion cards	Only for device with expansions: <ul style="list-style-type: none"> • 1 x PCIe-x4 expansion card can be used • Max. permissible power loss: 8 W

¹ For unique labeling, the Ethernet ports are numbered on the enclosure. The numbering by the operating system can differ.

² Teaming can be set and initiated in the configuration interface. In teaming operation, jumbo frames, e.g. for the camera application, are not supported.

8.4.2 Environmental conditions

Climatic ambient conditions

Permitted ambient temperature during operation			
Temperature, tested according to IEC 60068-2-1, IEC 60068-2-2			
15" display	At an ambient temperature > 40 °C, the device must be operated in an operating area in accordance with RAL.		
	When installed vertically in horizontal format	With HDD: With CFast or SSD:	+5 to +35 °C +0 to +50 °C
	When installed inclined in horizontal format, Vertical inclination max. ± 45°	With CFast or SSD:	+0 to +50 °C
	When installed upright in vertical format, Display rotated 90° vertical from the standard position (Power supply is located at the top)	With CFast or SSD:	+0 to +40 °C
19" display 22" display 24" display	At an ambient temperature > 40 °C, the device must be operated in an operating area in accordance with RAL.		
	When installed vertically in horizontal format	With HDD: With CFast or SSD:	+5 to +35 °C +0 to +45 °C
	When installed inclined in horizontal format, Vertical inclination max. ± 45°	With CFast or SSD:	+0 to +40 °C
	When installed upright in vertical format, Display rotated 90° vertical from the standard position (Power supply is located at the top)	With CFast or SSD:	+0 to +40 °C
All touch devices	Temperature during storage/transport	-20 °C to +60 °C	
	Gradient	Operating mode: Max. 10 K/h; no condensation Storage: Max. 20 K/h; no condensation	
Note: The ambient temperature must be reduced by 5 °C for the setting "Performance Optimized" (see Assigning CPU power consumption parameters (Page 86)).			

Relative humidity, tested in accordance with IEC 60068-2-78, IEC 60068-2-30	
Operation	5 ... 85% at 30 °C, no condensation
Storage/transport	5 to 95 % at 25/55 °C, no condensation
Air pressure, in accordance with IEC 60068-2-13	
Operation	1080 hPa to 795 hPa, corresponds to an elevation of 1000 m to 2000 m
Storage/transport	1080 hPa to 660 hPa, corresponds to an elevation of 1000 m to 3500 m

Protection against foreign objects and water

Degree of protection	Explanation
Front	When mounted: <ul style="list-style-type: none"> • IP65 according to IEC 60529 • Front face only Type 4X/Type 12 (indoor use only) according to UL50
Rear panel	IP20 Touch protection test with standard test probes. There is no protection against ingress by water.

The degree of protection of the device front can only be guaranteed if the mounting seal is intact and lies flush against the mounting cutout.

Mechanical ambient conditions

Vibration, tested according to DIN IEC 60068-2-6	
Operation with HDD	10 Hz to 58 Hz: 0.375 mm 58 Hz to 200 Hz: 4.9 m/s ²
Operation with CFast and SSD	5 Hz to 8.4 Hz: 3.5 mm 8.4 to 200 Hz: 9.8 m/s ²
Operation with CFast and SSD with VESA adapter up to 22"	10 Hz to 58 Hz: 0.375 mm 58 Hz to 200 Hz: 4.9 m/s ²
Storage/transport	5 to 8.4 Hz: 3.5 mm 8.4 Hz to 500 Hz: 9.8 m/s ²
Shock resistance, tested in accordance with IEC 60068-2-27, IEC 60068-2-29	
Operation	50 m/s ² , 30 ms
Storage/transport	250 m/s ² , 6 ms

8.4.3 Power requirements of the components

Maximum power consumption of the auxiliary components

Auxiliary components		Maximum permitted power consumption			Max. total power
		+5 V	+3.3 V	+12 V	
USB device	High current	1 A	-	-	10 W (for all USB devices)
Display port		-	500 mA	-	
PCIe module		-	1.5 A	0.5 A	8 W (for the whole device)

¹ The total power of the PCIe and USB cards may not exceed 15 W

Note

Device can overheat!

To avoid overheating, the power loss per PCIe slot should not exceed 8 watts.

8.4.4 Integrated DC power supply

Input voltage	24 V DC (-20%/+20%)
Output power of the power supply	Max. 80 W
Power failure buffering	Hold-up time ≥ 20 ms with 20.4 V (DC_FAIL is active after > 5 ms)
Efficiency	>85 %

Note

Inrush current

At least 5 A inrush current for 15 ms is required for device startup.

The peak value of the starting current depends on the input voltage and the impedance of the 24 V DC power supply. Peak currents greater than 6.5 A are possible. This will not have a negative impact on device functionality.

8.4.5 AC voltage supply

Input voltage	100-240 VAC (-15 % / +20 %); 50-60 Hz
Output power of the power supply	Max. 80 W
Power failure buffering	"AC FAIL" becomes active after ≥ 20 ms, The power supply continues to buffer for ≥ 20 ms at ≥ 93 V
Efficiency	>85 %

Note

Inrush current

The power consumption of the device is dependent on the device configuration and can be up to 1.1 A.

The peak value of the starting current depends on the input voltage and the impedance of the power supply, and can be up to 50 A for < 1 ms. This will not have a negative impact on device functionality.

8.5 Hardware descriptions

8.5.1 External ports

8.5.1.1 Serial interface

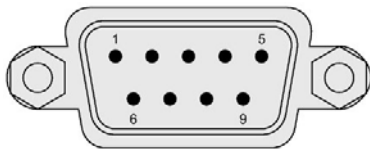

RS232
RS422
RS485

RS-232 assignment

Pin	Short description	Meaning
1	DCD	Data carrier detect (I)
2	RxD	Received data (I)
3	TxD	Transmitted data (O)
4	DTR	Data terminal ready (O)
5	M	Ground
6	DSR	Data set ready (I)
7	RTS	Request to send (O)
8	CTS	Clear to send (I)
9	RI	Incoming call (I)

Pin assignment RS422

Pin	Short description	Meaning
1	TX-	Transmit data - (O) for full-duplex mode
2	TX+	Transmit data + (O) for full-duplex mode
3	RX+	Receive data + (I) for full-duplex mode
4	RX-	Receive data - (I) for full-duplex mode
5	M	Signal ground
6	nc	
7	nc	
8	nc	
9	nc	

Pin assignment RS485

Pin	Short description	Meaning
1	Data-	Transmit / receive data - (I/O) for half-duplex mode
2	Data+	Transmit / receive data+ (I/O) for half-duplex mode
3	nc	
4	nc	
5	M	Signal ground
6	nc	
7	nc	
8	nc	
9	nc	

8.5.1.2 CFast

Pin	Short name	Meaning
S1	SGND	Signal GND (ground for signal integrity)
S2	A+	SATA differential
S3	A-	SATA differential
S4	SGND	Signal GND (ground for signal integrity)
S5	B-	SATA differential
S6	B+	SATA differential
S7	SGND	Signal GND (ground for signal integrity)
PC1	CDI	Card Detect In
PC2	GND	Device GND
PC3	TBD	TBD (not connected)
PC4	TBD	TBD (not connected)
PC5	TBD	TBD (not connected)
PC6	TBD	TBD (not connected)
PC7	GND	Device GND
PC8	LED1	LED Output (not connected)
PC9	LED2	LED Output (not connected)
PC10	IO1	Reserved Input/Output (not connected)
PC11	IO2	Reserved Input/Output (not connected)
PC12	IO3	Reserved Input/Output (not connected)
PC13	PWR	Device Power (3.3V)
PC14	PWR	Device Power (3.3V)
PC15	GND	Device GND
PC16	GND	Device GND
PC17	CDO	Card Detect Out

8.5.1.3 DisplayPort

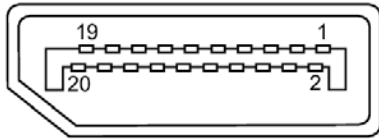

Pin	Short name	Meaning	Input / output
1	ML_Lane0+	DP data 0+	Output
2	GND	Ground	-
3	ML_Lane0-	DP data 0-	Output
4	ML_Lane1+	DP data 1+	Output
5	GND	Ground	-
6	ML_Lane1-	DP data 1-	Output
7	ML_Lane2+	DP data 2+	Output
8	GND	Ground	-
9	ML_Lane2-	DP data 2-	Output
10	ML_Lane3+	DP data 3+	Output
11	GND	Ground	-
12	ML_Lane3-	DP data 3-	Output
13	CONFIG1 CAD	Cable Adapter Detect	Input
14	CONFIG2	Ground (PullDown)	-
15	AUX_CH+	Auxiliary channel+	Bidirectional
16	GND	Ground	-
17	AUX_CH-	Auxiliary channel-	Bidirectional
18	HPD	Hot Plug Detect	Input
19	GND	Ground	-
20	DP_PWR	+3.3V (fused)	Output

8.5.1.4 Ethernet

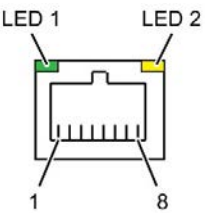
Ethernet RJ45 interface			
			
Pin no.	Short description	Meaning	Input / output
1	BI_DA+	Bi-directional data A+	Input/output
2	BI_DA-	Bi-directional data A-	Input/output
3	BI_DB+	Bi-directional data B+	Input/output
4	BI_DC+	Bi-directional data C+	Input/output
5	BI_DC-	Bi-directional data C-	Input/output
6	BI_DB-	Bi-directional data B-	Input/output
7	BI_DD+	Bi-directional data D+	Input/output
8	BI_DD-	Bi-directional data D-	Input/output
S		Shield	–
	LED 1	Off: 10 Mbps Green light: 100 Mbps Orange light: 1000 Mbps	–
	LED 2	Lit: Active connection, e.g., to a hub Flashing: Activity	–

8.5.1.5 USB 3.0 port

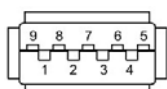

Pin	Short name	Meaning	Input / output
1	VBUS	+ 5 V (fused)	Output
2	D-	Data channel USB2	Input / output
3	D+	Data channel USB2	Input / output
4	GND	Ground	–
5	RX-	Data channel USB3	Input
6	RX+	Data channel USB3	Input
7	GND	Ground	–
8	TX-	Data channel USB3	Output
9	TX+	Data channel USB3	Output

8.5.1.6 USB 2.0

USB 2.0 port		
		
Pin no.	Short description	Meaning
1	USB_P5V_fused (O)	+ 5 V (fused) for external USB interface
2	USB_D0M (I/O)	Data-, USB channel 0
3	USB_D0P (I/O)	Data+, USB channel 0
4	USB_GND	Ground for external USB interface

8.5.2 Internal ports

8.5.2.1 PCIe card

Pin assignment for the PCIe-x4 card interface				
Pin no.	Side B		Side A	
	Name	Description	Name	Description
1	+12 V	12 V power	PRSNT1#	Hot-plug presence detect
2	+12 V	12 V power	+12 V	12 V power
3	+12 V	12 V power	+12 V	12 V power
4	GND	Ground	GND	Ground
5	SMCLK	SMBUS (System Management Bus) clock	JTAG2	TCK (Test Clock), clock input for JTAG interface (not connected)
6	SMDAT	SMBus (System Management Bus) data	JTAG3	TDI (Test Data Input) (not connected)
7	GND	Ground	JTAG4	TDO (Test Data Output) (not connected)
8	+3.3 V	3.3 V power	JTAG5	TMS (Test Mode Select) (not connected)
9	JTAG1	TRST# (Test Reset) resets the JTAG interface (not connected)	+3.3 V	3.3 V power
10	3.3 Vaux	3.3 V auxiliary power	+3.3 V	3.3 V power
11	WAKE#	Signal for link reactivation	PERST#	Fundamental reset
12	RSVD	Reserved	GND	Ground
13	GND	Ground	REFCLK+	Reference clock (differential pair)
14	PETp0	Transmitter differential pair, Lane 0	REFCLK-	Reference clock (differential pair)
15	PETn0	Transmitter differential pair, Lane 0	GND	Ground
16	GND	Ground	PERp0	Receiver differential pair, Lane 0
17	PRSNT2#	Hot-plug presence detect (not connected)	PERn0	Receiver differential pair, Lane 0
18	GND	Ground	GND	Ground
19	PETp1	Transmitter differential pair, Lane1	RSVD	Reserved
20	PETn1	Transmitter differential pair, Lane1	GND	Ground

Pin assignment for the PCIe-x4 card interface				
21	GND	Ground	PERp1	Receiver differential pair, Lane1
22	GND	Ground	PERn1	Receiver differential pair, Lane1
23	PETp2	Transmitter differential pair, Lane2	GND	Ground
24	PETn2	Transmitter differential pair, Lane2	GND	Ground
25	GND	Ground	PERp2	Receiver differential pair, Lane2
26	GND	Ground	PERn2	Receiver differential pair, Lane2
27	PETp3	Transmitter differential pair, Lane3	GND	Ground
28	PETn3	Transmitter differential pair, Lane3		Ground
29	GND	Ground	PERp3	Receiver differential pair, Lane3
30	RSVD	Reserved	PERn3	Receiver differential pair, Lane3
31	PRSNT2#	Hot-plug presence detect	GND	Ground
32	GND	Ground	RSVD	Reserved

8.5.3 System resources

8.5.3.1 Currently allocated system resources

All system resources (hardware addresses, memory configuration, allocation of interrupts, DMA channels) are assigned dynamically by the Windows OS, depending on the hardware configuration, drivers and connected external devices. You can view the current configuration of system resources or possible conflicts with the following operating systems:

Windows Embedded Standard and Windows 7 Ultimate	Start menu "Start": Enter "msinfo32" in the search field and press "Return" to confirm.
--	---

8.5.3.2 Assignment of system resources

The following tables and images describe the system resources for the delivery state of the device.

The interrupts are assigned to devices by BIOS. Only non-shared interrupts are available for the first Ethernet interface.

This means that applications or realtime operating system expansions can operate these devices exclusively and with high-performance without having to share the interrupt with other devices.

Interrupt sharing in APIC mode:

Interrupt		Interrupt type
IRQ0	HPET (High Precision Event Timer), when HPET is enabled in the BIOS "Advanced" menu. System Timer, when HPET is disabled.	ISA exclusive
IRQ1	Free	
IRQ2	Interrupt controller 2	ISA exclusive
IRQ3	Com Port 2 (COM2)	ISA exclusive
IRQ4	Com Port 1 (COM1)	ISA exclusive
IRQ5	CAN (optional)	ISA exclusive (CAN)
IRQ6	Free	
IRQ7	Free	
IRQ8	System CMOS / real-time clock	ISA exclusive
IRQ9	ACPI-SCI (system control interrupt)	
IRQ10	Free	
IRQ11	Free	
IRQ12	Free	
IRQ13	Numeric data processor	ISA exclusive
IRQ14	Free	
IRQ15	Free	

Interrupt		Interrupt type
IRQ16	High Definition Audio Controller SATA AHCI Controller LAN1 (I219-LM) Graphics Management Engine Interface USB XHCI Controller	PCI shared
IRQ17	PCIe-x4 slot on Riser	PCI exclusive
IRQ18	PCIe-x4 slot on Riser LAN2 (I210)	PCI shared
IRQ19	LAN3 (I210) (optional)	PCI exclusive
IRQ20	Free	
IRQ21	Free	
IRQ22	Free	
IRQ23	Free	

8.5.4 I/O Address Areas

8.5.4.1 Overview of the internal module registers

The following addresses are used for the internal registers:

Addresses	Input/output unit
I/O 062h	Watchdog enable register / 066h select register (read/write, address 062h) (Page 147)
I/O 066h	Watchdog trigger register (read only, address 066h) (Page 148)
I/O 404Eh	Output register user LED L1/L2/L3 (read/write, address 404Eh) (Page 148)
I/O 50Ch	Battery status register (read-only, address 404Dh) (Page 149)

8.5.4.2 Watchdog enable register / 066h select register (read/write, address 062h)

Meaning of the bits

Watchdog enable register / 066h select register (r/w address 062h)								
Bit								Meaning of the bits
7	6	5	4	3	2	1	0	
								Watchdog enable bit (WDE)
							0	Watchdog circuit disabled
							1	Watchdog circuit enabled
								Watchdog Mode
							0	Standard
							1	Macro
								066h select register selection
							0	Reserved
							1	
								Scaler watchdog time (Normal/Macro)
		0	0	0				94 ms / 2 s (default)
		0	0	1				210 ms / 4 s
		0	1	0				340 ms / 6 s
		0	1	1				460 ms / 8 s
		1	0	0				590 ms / 16 s
		1	0	1				710 ms / 32 s
		1	1	0				840 ms / 48 s
		1	1	1				960 ms / 64 s
								Trigger red Watchdog LED
	0							Red LED (WD) off
	1							Red LED (WD) on
								Watchdog error / Display and reset

Watchdog enable register / 066h select register (r/w address 062h)							
0							WD inactive
1							WD triggered Reset LED after watchdog alarm (Bit 7 = write 1)

8.5.4.3 Watchdog trigger register (read only, address 066h)

Watchdog trigger register

The watchdog is triggered by a read action (address 066h) by this register. The result of the read access can be disregarded (i.e., dummy read).

8.5.4.4 Output register user LED L1/L2/L3 (read/write, address 404Eh)

Meaning of the bits

The "PC ON/WD" LED flashes yellow to indicate the progress of the BIOS self-test during device startup. After the BIOS self-test has been completed, the "PC ON/WD" LED lights up continuously green.

Output register L1/L2/L3 (read/write, address 404Eh)							
Bits							
15	14	13	12-8	7	6	5	4-0
1				1			LED L1 / Run/Stop dark (default)
1				0			LED L1 / Run/Stop lit yellow
0				x			LED L1 / Run/Stop lit green
	1				1		LED L2 / SF dark (default)
	0				x		LED L2 / SF lit red
	1				0		LED L2 / SF lit yellow
		1				1	LED L3 / Maint dark (default)
		0				x	LED L3 / Maint lit red
		1				0	LED L3 / Maint lit yellow
		xxxx xx				xxxx xx	Reserved (read/write)

8.5.4.5 Battery status register (read-only, address 404Dh)

To monitor the status of the CMOS battery, the battery monitoring must be switched on via a special GPIO register.

The status of the CMOS battery (two-tier) can be read out via the battery status register.

Meaning of the bits

Battery status register (read-only, address 404Dh)								
Bit								Meaning
7	6	5	4	3	2	1	0	
0	0							CMOS battery capacity is still sufficient.
0	1							CMOS battery capacity is exhausted (remaining capacity is sufficient for approx. one month)
1	1							CMOS battery is empty

8.5.4.6 NVRAM address register

NVRAM occupies a 512 KB memory address area that can be read via PCI registers.

Meaning of the bits

NVRAM address register		
PCI register address: NVRAM base address register	PCI register content: NVRAM memory address (default)	Length of the memory area
E300 0000	Address is assigned dynamically (depending on device configuration)	80000 h

8.6 BIOS description

8.6.1 Overview

Parameterize your device in the BIOS Setup.

BIOS Setup program

The BIOS Setup program, or BIOS Setup for short, is located, together with the setup parameters, in a FLASH block on the motherboard.

Change the setup parameters of the device in the BIOS Setup, e.g. system time or boot sequence.

Changing the device configuration

Your device configuration is preset for operating with the included software. You should only change the default setup parameters if technical modifications to your device require different parameters.

NOTICE
Malfunctions can occur with running software CPU
If a BIOS update of the PC is performed while SIMATIC software controller, a SIMATIC WinAC for example, is running, the software CPU can malfunction, resulting in communication interruptions or failures, for example. Other actions that put a heavy load on the PC hardware, for example, running hardware tests such as benchmarks, can result in malfunctions of the software CPU.
Do not run a BIOS update or other actions that would put a heavy load on the hardware during operation of a software CPU.
Switch the software CPU to "STOP" before you run a BIOS update or perform other critical actions.

Note

Documentation

BIOS Setup is described for all devices and device configurations. Some BIOS submenus or Setup parameters may not be included, depending on your order. The interface of your BIOS Setup can deviate from the figures in this document.

You can find a detailed description of the BIOS on the Support website under Entry ID 92189178 (<http://support.automation.siemens.com/WW/view/en/92189178>).

8.6.2 Opening the BIOS selection menu

Procedure

1. Switch on the device or restart the device.
2. Immediately after switching on the device, press the "Esc" button and keep it pressed.

Note

The following message appears briefly after the device is switched on:

Press ESC for boot options

The BIOS selection setup appears:



The number of buttons in the BIOS selection setup depends on your device version.

The following buttons are available:

Buttons	Function
Continue	Exit selection menu, continue start sequence
Boot Manager	Specify the boot media from which to start, for example: <ul style="list-style-type: none">• Hard disk drive• USB device
Device Management	Start device manager for UEFI boot media

Buttons	Function
Boot From File	Boot Maintenance Manager: <ul style="list-style-type: none"> • Boot Options: Set boot order • Driver Options: Configure drivers • Console Options: Configure connected input device • Boot from File: Start from an ".EFI" file • Reset System: Restoring factory settings
Secure Boot Option ¹	Configuration settings to start the device in Secure Boot mode. The only software modules loaded are those that are known to be safe for the BIOS or the operating system.
SCU	Setup Configuration Utility: The BIOS Setup
BIOS Update	Update BIOS from USB memory stick
MEBx ²	Intel Management Engine BIOS Extension from Active Management Technology Support (AMT)

¹ Available as of Windows 8, if supported by device

² Only if the hardware supports AMT

8.6.3 Structure of the BIOS Setup menu

The individual setup parameters are distributed between different menus and submenus. Not all menus are included in each supplied device configuration. The following table shows the menus.

Menu	Meaning
Main	Display system information, for example, BIOS version, processor and memory
Advanced	Configure hardware using different submenus
Security	Security functions, e.g., setting a password
Power	Specify power management of CPU and the device
Boot	Determine boot options, e.g., boot order
Exit	Save and exit (see Exit menu)

The menus always have the same structure. The figure below shows an example for the "Main" menu. Device-specific information is shown blurred.

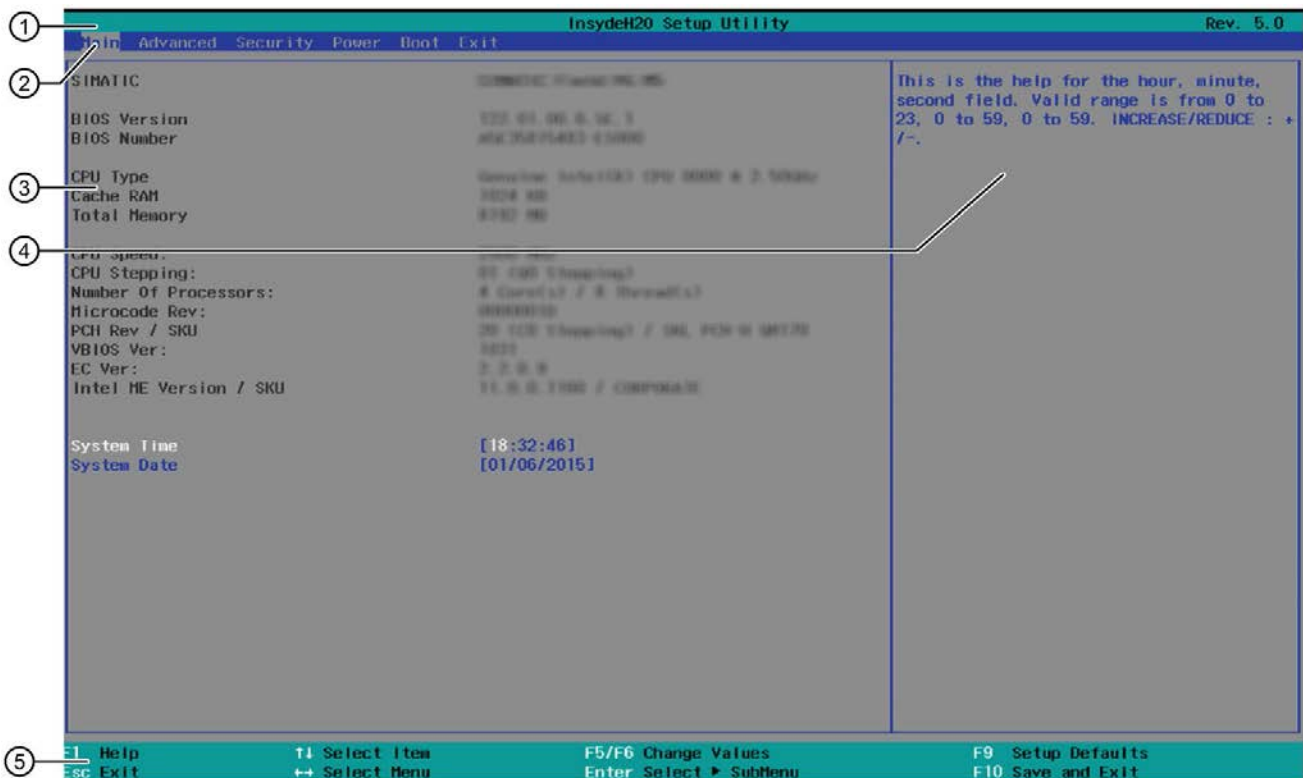

- ① Header
The current version of the selected BIOS Setup is displayed in the header.
- ② Menu bar
Switch between the various menus "Main", "Advanced", etc. in the menu bar at the top.
- ③ Settings, submenus and device-specific information
Information about your device is displayed in the center left-hand area; here you can edit settings which are partly in submenus.

- | | |
|------------------|--|
| ④ Help area | Short help texts on the currently selected setup parameters are displayed in the center right-hand area. |
| ⑤ Key assignment | The key assignment for navigation in the BIOS Setup is found in the footer. |

8.6.4 Exit menu

You always exit BIOS Setup in this menu.

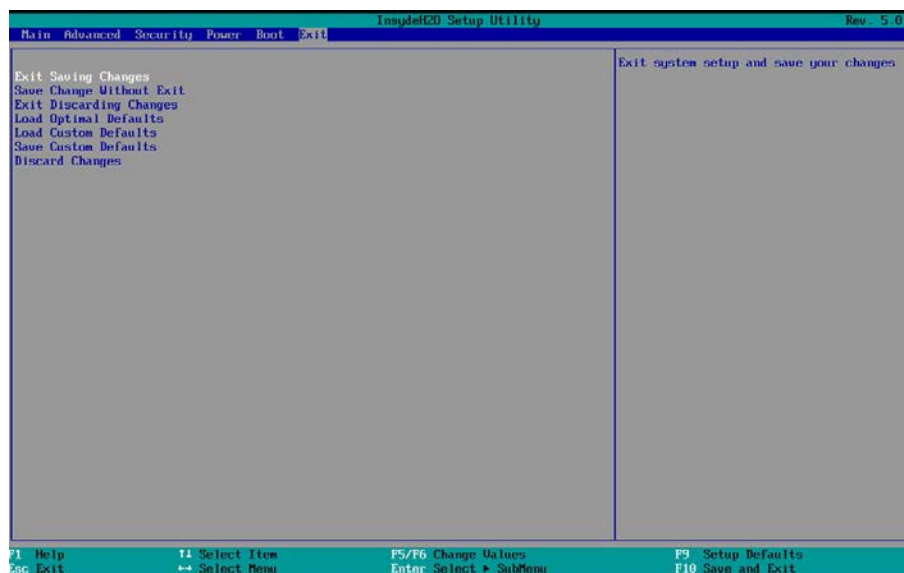

Exit Saving Changes	All changes are saved and the system is restarted with the new Setup parameters.
Save Change Without Exit	All changes are saved
Exit Discarding Changes	All changes are discarded and the system is restarted with the old Setup parameters.
Load Optimal Defaults	All setup parameters are reset to the safe default values. Notice: The existing Setup parameters are overwritten by this.
Load Custom Defaults	The profile must be loaded with the custom Setup parameters. Requirement: The parameters are saved prior to this with "Save Custom Defaults".
Save Custom Defaults	The currently configured Setup parameters are saved as a custom profile (see also "Load Custom Defaults").
Discard Changes	All changes are discarded.

See also

SIMATIC IPC after-sales information system (<http://www.siemens.com/asis>)

8.6.5 BIOS update

Check regularly if updates are available for download to your device.

Additional information can be found on the Internet at the following address: After-sales information system for SIMATIC PC/PG (<http://www.siemens.com/asis>).

Noting down and restoring BIOS Setup settings

NOTICE

Irretrievable loss of data

All BIOS Setup settings are deleted after the BIOS update. This can put the system in an undefined state. This may damage the device and the plant.

1. Make a note of your specific BIOS Setup settings before the BIOS update.
2. Start BIOS Setup after the BIOS update.
3. Load the BIOS Setup default settings with <F9> "Setup Defaults". Or use the BIOS Setup command "Load Optimal Defaults" in the "Exit" menu.
4. Make your own Setup settings based on the table you have printed out.
5. Save the BIOS Setup settings with <F10> "Save and Exit".

Performing a BIOS update

NOTICE

Damage to the device

If you switch off the device during the update, the BIOS will be incomplete and corrupt. This may result in malfunctions.

Leave the device switched on during the update.

If you have purchased a new BIOS update for your device, follow these steps to install the update:

1. Connect the device to the power supply.
2. Copy the update to a USB memory stick.
3. Reset the device (warm or cold restart).

The following message appears briefly on the display at the end of the self-test:

`Press ESC for boot options`

4. Press <ESC> to open the BIOS selection menu.
5. Click the "BIOS Update" button.
6. Follow the instructions on the screen.

Reboots

There may be several reboots after a BIOS update. These reboots are initiated by the Management Engine (ME). The reboots are required by the ME to adapt itself to the changes of the BIOS update.

8.6.6 Alarm, error and system messages

During startup (the boot process), the BIOS first performs a **Power On Self Test (POST)** and checks whether certain functional units of the PC are operating error-free. The boot sequence is immediately interrupted if critical errors occur.

BIOS initializes and tests further functional units if the POST does not return any errors. In this startup phase, the graphics controller is initialized and any error messages are output to the screen.

The error messages output by system BIOS are listed below. For information on error messages output by the operating system or application programs, refer to the corresponding manuals.

On-screen error messages

On-screen error message	Meaning / tip
Operating system not found	Possible causes: <ul style="list-style-type: none">• No operating system installed• Incorrect active boot partition• Wrong boot drive settings in SETUP
SMART failure detected on HDD	Hard disk reports pending failure through S.M.A.R.T.
CMOS battery failed	CMOS battery is empty or not connected.
Real-time clock has lost power	The CMOS clock was operated without battery or with a battery that was too weak, during battery change, for example. Check the CMOS clock.
Keyboard controller error or no keyboard present	Keyboard defective or not connected

8.7 Active Management Technology (AMT)

8.7.1 Introduction

Intel® Active Management Technology (Intel® AMT) is an Intel technology for the remote maintenance of SIMATIC Industrial PCs (IPCs) with AMT technology using a management PC. It is not necessary to install an operating system on the SIMATIC IPC with Intel® AMT. Intel® AMT provides numerous functions, e.g.:

- **Keyboard Video Mouse (KVM) Redirection**

KVM connections are always possible using the KVM server that is integrated in the firmware. KVM enables access to IPCs with a corrupted or no operating system as the KVM server is integrated in the AMT hardware. KVM enables you to reboot a remote computer and make changes to its BIOS settings.

- **Remote power management**

SIMATIC IPC with Intel® AMT can be switched on and off or restarted using another PC.

- **IDE redirection**

An image on the management PC can be integrated and used on the SIMATIC IPC with Intel® AMT both as a CD/DVD drive and as a floppy drive. If the image is bootable, you can also boot the SIMATIC IPC with Intel® AMT from it.

The following figure shows remote maintenance of SIMATIC IPCs with Intel® AMT, e.g. for troubleshooting a corrupt operating system or incorrect BIOS settings:

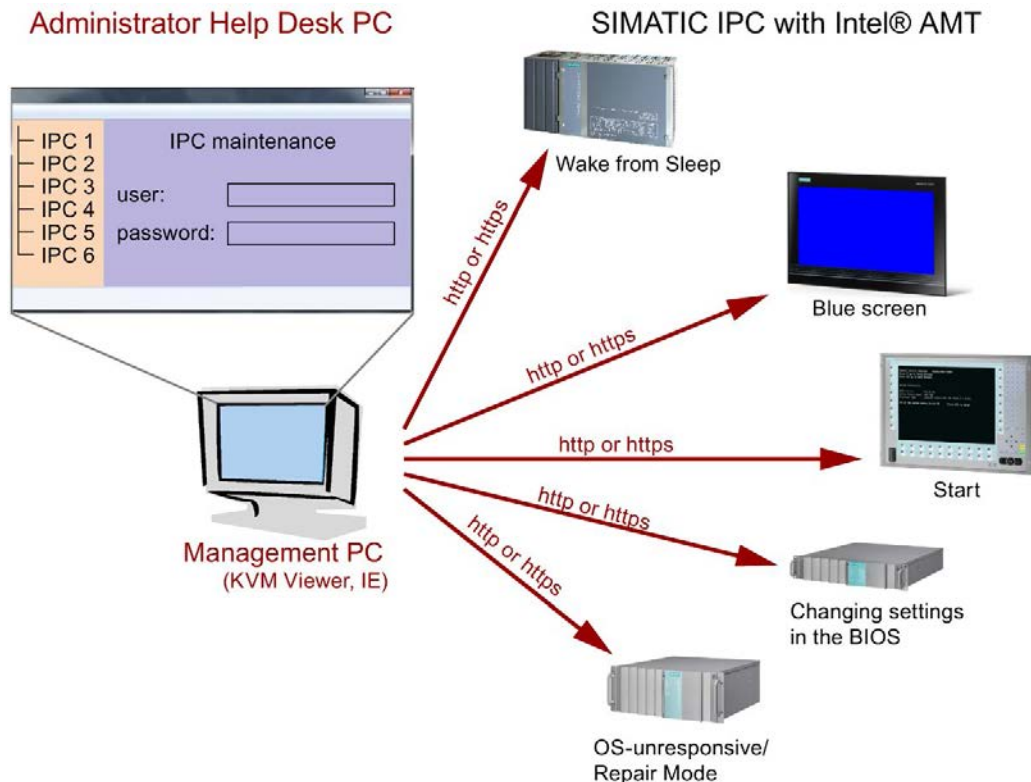

8.7.2 Overview of AMT

This section describes the required measures and settings on the local IPC so that the IPC can be controlled and maintained remotely from a management station known below as the help desk PC.

The local IPC is known below as the "AMT PC".

The sections contain the following information:

- AMT settings in the MEBx and in the BIOS setup
- Basic configuration of AMT
- Further useful notes

8.7.3 Enabling Intel® AMT / basic configuration

For security reasons, Intel® AMT is not enabled on new devices. The Management Engine (ME) is always active.

Procedure

For IPC477E:

1. If necessary, first reset Intel® AMT to the default settings (see Resetting the Intel® AMT to the default settings and disabling AMT (Page 161)).
2. To open the BIOS selection menu, press the <ESC> key while the device is booting.
3. Open the BIOS Setup using the "Setup Configuration Utility (SCU)".
4. Select the "Active Management Technology Support" command in the Advanced menu.
5. Activate the option "Intel AMT Configuration Screens".
6. Exit the BIOS Setup with <F10> key (Save and Exit).

Settings in the MEBx

1. Use the arrow keys to select "MEBx" and confirm with the <Enter> key.
2. Select "MEBx Login".

3. Enter the default password "admin".

Change the password. The new password must comprise:

- At least eight characters
- An upper case letter
- A lower case letter
- A number
- A special character (! @ # \$ % ^ & *)
- The underscore "_" and space characters are valid in the string but do not increase the complexity of the password.

Note

If the password is no longer available, you must reset the Intel® AMT to the default settings (Page 161).

Backup the password to protect it against loss.

4. Switch to the "Intel (R) AMT Configuration" submenu and enable "Manageability Feature Selection".
5. Switch to the "Intel(R) ME General Settings" submenu and enable access via the network with "Activate Network Access".
6. Confirm the dialogs that appear with "Y".

Drivers are automatically installed once with the Windows system start in the subsequent restart.

8.7.4 Resetting the Intel® AMT to the default settings and disabling AMT

If Intel® AMT has already been configured, it is advisable to reset Intel® AMT to the default settings. One effect of resetting to the default settings is that Intel® AMT is disabled.

You can skip this point if you have a new IPC in the factory state.

Procedure

Proceed as follows to reset the Intel® AMT to the default values:

1. To open the BIOS selection menu, press the <ESC> key while the device is booting.
2. Open the BIOS Setup using "Setup Configuration Utility (SCU)".
3. Select the "Active Management Technology Support" command in the Advanced menu.
4. Activate the options "Intel AMT Configuration Screens" and "Un-Configure ME".
5. Exit the BIOS with "F10" (Save and Exit).
6. The following prompt will appear after an automatic restart:

```
Found unconfigure of Intel(R) ME
Continue with unconfiguration (Y/N)
```

7. Confirm this prompt with "Y" to discard all settings in the Management Engine (ME).

The following message appears: "Unconfiguration in process...". The device is automatically restarted.

8.7.5 Determining the network address

To connect the AMT PC with the AMT server, the network address that uniquely localizes the AMT server on the AMT PC must be entered.

If DHCP is set for the automatic assignment of the network address in "Network Setup" in the MEBx of the AMT PC, the network address is not fixed.

Procedure

If the AMT server uses the same network address as the operating system of the AMT PC (most common situation):

1. You can obtain the address of the AMT server in the command line in Windows using "ipconfig" and in UNIX using "ifconfig".

If the AMT server and operating system do not use the same network address, ask your network administrator for the address you have been assigned.

8.7.6 Forcing user consent

When establishing a connection to the AMT PC, the KVM viewer may prompt the user to enter a six-figure code. This code is displayed on the screen of the AMT PC. The user of the AMT PC must inform the user of the KVM viewer of this code.

This code query needs to be set up on the KVM viewer.

Procedure

1. Select "Intel(R) AMT Configuration > User Consent" in the MEBx.
2. Select the value "KVM" for "User Consent".

To allow a user with administrator privileges to avoid this code query, follow these steps:

1. Select "Intel(R) AMT Configuration > User Consent" in the MEBx.
2. Enable "Opt-in configurable from remote IT".

8.8 Scope of functions in Windows Embedded Standard 7

The overview shows the most important device functions under Windows Embedded Standard 7:

Function	HDD / SSD version	Memory card version
.Net Framework	Available, V3.5	Available, V3.5
Accessories	Available	Available
Aero background	Available	Available
Backup and Restore	Available	Available
Bluetooth	Available	Available
Dialog box filter	Available	Available
DirectX and Windows Device Experience	Available, V11	Available, V11
Domain services	Available	Available
Driver database	Available	Not available
Driver frameworks	Available	Available
Encrypted File System (EFS)	Available	Available
Enhanced Write Filter	Available	Available
Fax and Scan	Available	Available
File Based Write Filter (FBWF)	Available	Available
Fonts	134	48
Help and Support Engine	Available	Available
Hibernate Once Resume Many (HORM)	Available	Available
Image Mastering API V2	Available	Available
IME Base Components	Available	Available
Internet Explorer	Available, IE 11	Available, IE 11
Internet Information Server (IIS)	Available, V7.0	Available, V7.0
Language (Standard)	English ¹	English ¹
Mobility Center	Available	Available
Network and Sharing Center	Available	Available
Network Diagnostics	Available	Available
Pagefile	Available	Available
Printing Utilities and Management	Available	Available
Registry Filter	Available	Available
Remote Assistance	Available	Available
Remote Client	Available	Available
Remote Desktop	Available	Available
SIMATIC IPC DiagBase	Available	Available
Speech	Available	Not available
System Management Administrative Tools	Available	Available
Telnet Server	Available	Available
User Account Control	Available	Available

8.8 Scope of functions in Windows Embedded Standard 7

Function	HDD / SSD version	Memory card version
Windows Explorer Shell	Available	Available
Windows Firewall	Available	Available
Windows Installer	Available	Available
Windows Media Player	Available, V12	Available, V12
Windows PowerShell 2.0	Available	Available
Windows Search and Natural Language 6	Available	Available
Windows Security Center	Available	Available
Windows Update	Available	Available
Wireless Networking	Available	Available

¹ Note the licensing agreements for Windows Embedded Standard 7.

Additional information on language selection is available in the section "Setting up the language selection by means of the Multilanguage User Interface (MUI) (Page 101)".

Technical support

A.1 Service and support

You can find additional information and support for the products described on the Internet at the following addresses:

- Technical support (<https://support.industry.siemens.com>)
- Support request form (<http://www.siemens.com/automation/support-request>)
- After Sales Information System SIMATIC IPC/PG (<http://www.siemens.com/asis>)
- SIMATIC Documentation Collection (<http://www.siemens.com/simatic-tech-doku-portal>)
- Your local representative (<http://www.automation.siemens.com/mcms/aspa-db/en/Pages/default.aspx>)
- Training center (<http://sitrain.automation.siemens.com/sitrainworld/?AppLang=en>)
- Industry Mall (<https://mall.industry.siemens.com>)

When contacting your local representative or Technical Support, please have the following information at hand:

- MLFB of the device
- BIOS version for industrial PC or image version of the device
- Other installed hardware
- Other installed software

Tools & downloads

Please check regularly if updates and hotfixes are available for download to your device. The download area is available on the Internet at the following link:

After Sales Information System SIMATIC IPC/PG (<http://www.siemens.com/asis>)

A.2 Problem solving

This section provides you with tips on how to locate and/or troubleshoot problems which occur.

Problem	Possible cause	Possible remedy
The device is not operational	No power supply	<ul style="list-style-type: none"> • Check the power supply, the power cord and the power plug. • Check if the On/Off switch is in the correct position.
	Device is being operated outside the specified ambient conditions	<ul style="list-style-type: none"> • Check the ambient conditions. • After transport in cold weather, wait approximately 12 hours before switching on the device.
The monitor remains dark	The brightness button has been set to dark	Increase brightness using the brightness button. For detailed information, refer to the monitor operating instructions.
	Power cord is not connected	<ul style="list-style-type: none"> • Check whether the power cord has been properly connected to the monitor and to the system unit or to the grounded shockproof outlet. • If the monitor screen still remains dark after you have performed these checks and measures, contact your technical support team.
The mouse pointer does not appear on the screen	The mouse driver is not loaded	Check whether the mouse driver is properly installed and available when you start the user program. Detailed information about the mouse driver is available in the corresponding documentation.
	Mouse not connected.	<ul style="list-style-type: none"> • Check whether the mouse cord is properly connected to the system unit. • If you use an adapter or expansion for the mouse cable, also check these connectors. • If the mouse pointer still does not appear on the screen after you have performed these checks and actions, contact your technical support team.
Wrong time and/or date on the PC		<ol style="list-style-type: none"> 1. Press <F2> during the booting process to open the BIOS Setup. 2. Set the time and date in the setup menu.
Although the BIOS setting is OK, the time and data are still wrong.	The backup battery is dead.	Replace the backup battery.
USB device not responding.	The USB ports are disabled in BIOS.	Use a different USB port or enable the port.
	The operating system does not support the USB ports.	<ul style="list-style-type: none"> • Turn on USB Legacy Support for mouse and keyboard. • For other devices, you need the USB device drivers for the required operating system.
"chkdsk" is not functioning	EFW (Enhanced Write Filter) has been activated. The "chkdsk" command is not supported if the EFW has been activated.	Deactivate the EFW or use an alternative method to "chkdsk".

A.3 Notes on the use of third-party modules

Problem	Possible cause	Possible remedy
The PC crashes during startup.	<ul style="list-style-type: none"> • I/O addresses are assigned twice. • Hardware interrupts and/or DMA channels are assigned twice • Signal frequencies or signal levels are not adhered to • Different connector pin assignments 	<p>Check your computer configuration:</p> <ul style="list-style-type: none"> • If the computer configuration corresponds with factory state, please contact your technical support team. • If the computer configuration has changed, restore the original factory settings. Remove all third-party expansion cards, then restart the PC. If the error no longer occurs, the third-party expansion card was the cause of the fault. Replace this expansion card with a Siemens card or contact the card supplier.
		If the PC still crashes, contact your technical support team.
	PCIe Gen1 expansion card does not behave according to specification.	<ol style="list-style-type: none"> 1. Remove the expansion card. 2. Set the respective setup parameter "PCIe Speed" permanently to "Gen1" in the "Advanced > PCI Express Configuration" menu, submenu "PCI Express Root Port #" of the BIOS Setup. 3. Set the respective setup parameter "PEG# - Gen X" permanently to "Gen1" in the "Advanced > Video Configuration" menu, submenu "Pci Express Graphic" of the BIOS Setup. 4. Install the expansion card again.









Markings and symbols

B.1 Overview



The following tables show all the symbols which may be found on your SIMATIC industrial PC, SIMATIC industrial monitor or SIMATIC Field PG in addition to the symbols which are explained in the operating instructions.

The symbols on your device may vary in some details from the symbols shown in the following tables.

B.2 Safety











Symbol	Meaning	Symbol	Meaning
	Warning, observe the supplied documentation.		Lock is closed
	Attention, radio equipment		Lock is open
	Disconnect the power plug before opening		Opening for Kensington lock
	Attention ESD (Electrostatic sensitive device)		Warning of hot surface

B.3 Operator controls

Symbol	Meaning	Symbol	Meaning
	On/off switch, without electrical isolation		Eject CD/DVD
	On/off switch, without electrical isolation		

B.4 Certificates, approvals and markings



















The following table shows symbols relating to certificates, approvals and markings which may be on the device. You can find more information in the operating instructions for your device:

Symbol	Meaning	Symbol	Meaning
	Approved for Australia and New Zealand		Marking for the Eurasian Customs Union
	Approved for China		Test mark of Factory Mutual Research
	CE markings for European countries		Marking of Federal Communications Commission for the USA
	EFUP (Environment Friendly Use Period) marking for China		Approved for Korea
	Test mark of the Underwriters Laboratories		Disposal information, observe the local regulations.

B.5 Interfaces

The following table shows symbols relating to ports that may be available on the device.

You can find more information in the operating instructions for your device:

Symbol	Meaning	Symbol	Meaning
	Connection to the power supply		PS/2 mouse interface
	Protective conductor terminal		PS/2 keyboard-interface
	Connection for functional earthing (equipotential bonding line)		Multimedia Card Reader
DPP	DisplayPort interface		Smart Card Reader
	DVI-D interface		Line In
LAN 	LAN interface, not approved for connecting WAN or telephone		Line Out
	Serial port		Microphone input
	USB port		Universal Audio Jack
	USB 2.0 high-speed port		Headphone output
	USB 3.0 super-speed port		

List of abbreviations

Abbreviation	Term	Meaning
AC	Alternating current	Alternating current
ACPI	Advanced Configuration and Power Interface	
PLC	Programmable controller	
AGP	Accelerated Graphics Port	High speed bus system
AHCI	Advanced Host Controller Interface	Standardized controller interface for SATA devices. This is supported in Microsoft Windows XP as of SP1 and IAA driver.
APIC	Advanced Programmable Interrupt Controller	Extended programmable interrupt controller
APM	Advanced Power Management	Tool for monitoring and reducing power consumption of the PC
AS	Automation system	
ASIS	After Sales Information System	
AT	Advanced Technology	
ATA	Advanced Technology Attachment	
ATX	AT-Bus-Extended	
AWG	American Wire Gauge	US standard for the cable diameter
BIOS	Basic Input Output System	Basic Input Output System
CAN	Controller Area Network	
CD-ROM	Compact Disc – Read Only Memory	Removable storage medium for large data volumes
CD-RW	Compact Disc – Rewritable	Rewritable CD
CE	Communauté Européenne (CE symbol)	The product is in conformance with all applicable EC directives
CFast	CF + AST	The acronym CFast is the combination of CF (CompactFlash) and AST (ATA Serial Transport).
CGA	Color Graphics Adapter	Standard monitor interface
CLK	Clock pulse	Clock signal for controllers
CMOS	Complementary Metal Oxide Semiconductors	Complementary metal oxide semiconductors
COA	Certificate of authentication	Microsoft Windows Product Key
CoL	Certificate of License	License authorization
COM	Communications Port	Term for the serial interface
CP	Communication Processor	Communication computer
CPU	Central Processing Unit	CPU

Abbreviation	Term	Meaning
CRT	Cathode Ray Tube	
CSA	Canadian Standards Association	Canadian organization for tests and certifications according to own or binational standards (with UL / USA) standards
CTS	Clear To Send	Clear to send
DRAM	Dynamic Random Access Memory	
DC	Direct Current	DC current
DCD	Data Carrier Detect	Data carrier signal detection
DMA	Direct Memory Access	Direct memory access
DOS	Disk Operating System	Operating system without GUI
DPP	DisplayPort	New powerful digital monitor port
DQS	Deutsche Gesellschaft zur Zertifizierung von Qualitätsmanagement mBH	
DDRAM	Double Data Random Access Memory	Memory chip with high-speed interface
DSR	Data Set Ready	Ready for operation
DTR	Data Terminal Ready	Data terminal is ready
DVD	Digital Versatile Disk	Digital versatile disk
DVI	Digital Visual Interface	Digital display interface
DVI-I	Digital Visual Interface	Digital display interface with digital and VGA signals
ECC	Error checking and correction	Error correction code
ECP	Extended capability port	Extended parallel port
EFI	Extensible Firmware Interface	
EGA	Enhanced Graphics Adapter	PC to monitor interface
ESD	Electrostatic-sensitive components	
DM	Electronic Manual	
EIDE	Enhanced Integrated Drive Electronics	An enhancement of the IDE standard
EISA	Extended Industry Standard Architecture	Extended ISA standard
EMM	Expanded Memory Manager	Manages memory expansions
EM64T	Extended Memory 64 technology	
EN	European standard	
EPROM / EEPROM	Erasable Programmable Read-Only Memory / Electrically Erasable Programmable Read-Only Memory	Plug-in submodules with EPROM/EEPROM chips
EPP	Enhanced Parallel Port	Bi-directional Centronics interface
ESC	Escape character	Control character
EWf	Enhanced Write Filter	
FAQ	Frequently Asked Questions	FAQs
FAT 32	File Allocation Table 32-bit	32-bit file allocation table
FBWF	File Based Write Filter	
FD	Floppy disk	Disk drive, 3.5"
FSB	Front Side Bus	
GND	Ground	Chassis ground

Abbreviation	Term	Meaning
HD	Hard disk	Hard disk
HDA	High Definition Audio	
HDD	Hard Disk Drive	Hard disk drive
HU	Height unit	
HMI	Human Machine Interface	User interface
HORM	Hibernate Once - Resume Many	
HT	Hyper-Threading	
HTML	Hyper Text Markup Language	Script language for creating Internet pages.
HTTP	Hypertext Transfer Protocol	Protocol for data transfer on the Internet
Hardware	Hardware	
IAMT	Intel Active Management Technology	Technology that permits the diagnostics, management and remote control of PCs
I/O	Input/Output	Data input/output on computers
IAA	Intel Application Accelerator	
IDE	Integrated Device Electronics	
IEC	International Electrotechnical Commission	
IGD	Integrated Graphics Device	
IP	Ingress Protection	Degree of protection
IR	Infrared	Infrared
IRDA	Infrared Data Association	Standard for data transfer via IR module
IRQ	Interrupt Request	Interrupt request
ISA	Industry Standard Architecture	Bus for expansion modules
ITE	Information Technology Equipment	
L2C	Level 2 cache	
LAN	Local Area Network	Computer network that is limited to a local area.
LCD	Liquid Crystal Display	Liquid crystal display
LED	Light Emitting Diode	Light emitting diode
LPT	Line Printer	Printer port
LVDS	Low Voltage Differential Signaling	
LW	Drive	
MAC	Media access control	Media access control
MC	Memory Card	Memory card in credit card format
MLFB	Machine-readable product designation	
MMC	Micro Memory Card	Memory card of the format 32 mm x 24.5 mm
MPI	Multipoint-capable interface for programming devices	
MRAM	Magnetoresistive Random Access Memory	Non-volatile data memory. Data memory is retained without external power supply.
MS-DOS	Microsoft Disc Operating System	
MTBF	Mean Time Between Failures	
MUI	Multilanguage User Interface	Multilanguage operating system with Windows with language toggling; 5 languages: German, English, French, Spanish and Italian

Abbreviation	Term	Meaning
NA	Not Applicable	
NAMUR	Normenarbeitsgemeinschaft für Mess- und Regelungstechnik in der chemischen Industrie (standardization body for instrumentation and control technology in the chemicals industry)	
NC	Not Connected	Not connected
NCQ	Native Command Queuing	Automatic re-sorting of the file and disk access, for increased performance
NEMA	National Electrical Manufacturers Association	Syndicate of manufacturers of electrical components in the USA
NMI	Non Maskable Interrupt	Interrupt the processor can not reject
NTFS	New Techniques File System	Secure file system for Windows versions (2000, XP, 7)
NVRAM	Non Volatile Random Access Memory	Non-volatile data memory. Data memory is retained without external power supply.
ODD	Optical Disk Drive	
OPC	OLE for Process Control	Standardized interface for industrial processes
PATA	Parallel ATA	
PC	Personal computer	
PCI	Peripheral Component Interconnect	High-speed expansion bus
PCIe	Peripheral Component Interconnect express	High-speed serial, differential full-duplex PtP interface with high data rate.
PCMCIA	Personal Computer Memory Card International Association	
PE	Protective Earth	Protective conductor
PEG	PCI Express Graphics	
PG	Programming device	
PIC	Programmable Interrupt Controller	Programmable interrupt controller
PIC-E	Peripheral Component Interconnect Express	
POST	Power On Self Test	
PXE	Preboot Execution Environment	Software for running new PCs without hard disk data via the network
RAID	Redundant Array of Independent Disks	Redundant hard disk array
RAL	Restricted Access Location	Installation of device in operating facilities with restricted access - for example, a locked switch-gear cabinet
RAM	Random Access Memory	
RI	Ring Input	Incoming call
ROM	Read-Only Memory	
RS 485	Reconciliation Sublayer 485	Bi-directional bus system designed for up to 32 nodes
RTC	Real Time Clock	Real-time clock
RTS	Reliable Transfer Service	Request to send
RxD	Receive Data	Data transfer signal

Abbreviation	Term	Meaning
SATA	Serial Advanced Technology Attachment	
SCSI	Small Computer System Interface	
SDRAM	Synchronous DRAM	
SELV	Safety Extra Low Voltage	Safety extra low voltage
SLC	Second Level Cache	
SMART	Self Monitoring Analysis and Reporting Technology	Hard disk error diagnostics program
SMS	Short Message Service	Short message via telecommunication network
SNMP	Simple Network Management Protocol	Network protocol
SO-DIMM	Small Outline Dual Inline Memory Module	
SOM	SafeCard on Motherboard (SOM)	
SPP	Standard Parallel Port	Synonym for parallel port
SRAM	Static Random Access Memory	Static RAM
SSD	Solid State Drive	
SVGA	Super Video Graphics Array	Enhanced VGA standard with at least 256 colors
SVP	Serial number of the device	
SW	Software	
TCO	Total Cost of Ownership	
TFT	Thin-Film-Transistor	Type of LCD flat-screen
TPM	Trusted Platform Module	Chip with security functions
TTY	Tele Type	Asynchronous data transfer
TxD	Transmit Data	Data transfer signal
TXT	Trusted Execution Technology	Hardware implementation
TWD	Watchdog Time	Watchdog monitoring time
UEFI	Unified Extensible Firmware Interface	
UL	Underwriters Laboratories Inc.	US organization for tests and certifications according to own or binational standards (with CSA / Canada) standards.
UMA	Unified Memory Architecture	Video memory
URL	Uniform Resource Locator	Designation of the full address of an Internet page
USB	Universal Serial Bus	
UXGA	Ultra Extended Graphics Array	Graphic standard, maximum resolution 1600x1200 pixels.
V.24		ITU-T standardized recommendation for data transfer via serial ports
VCC		Positive supply voltage of integrated circuits
VDE	Verein deutscher Elektrotechniker (Union of German Electrical Engineers)	
VGA	Video Graphics Array	Video adapter which meets industrial standard
VRM	Voltage Regulator Module	
VT	Virtualization Technology	Intel technology with which a virtually closed environment can be made available.

Abbreviation	Term	Meaning
VT-D	Virtualization Technology for Directed I/O	Enables the direct assignment of a device (e.g. network adapter) to a virtual device.
W2k	Windows 2000	
WAN	Wide Area Network	
WAV	Wave Length Encoding	Loss-free file format for audio data
WD	Watchdog	Program monitoring with error detection and alarming.
WLAN	Wireless LAN	LWireless local area network
WoL	Wake on Local Area Network	
WWW	World Wide Web	
XD	Execute Disable Capability	Hardware implementation
XGA	Extended Graphics Array	Graphic standard, maximum resolution 1024x768 pixels.

Glossary

AHCI mode

AHCI is a standardized method to address the SATA controller. AHCI describes a structure in the RAM, which contains a general area for control and status, as well as a command list.

APIC mode

Advanced peripheral interrupt controller. 24 interrupt lines are available.

Automation system

A programmable controller (PLC) of the SIMATIC S7 system consist of a central controller, one or several CPUs, and various I/O modules.

Backup

Duplicate of a program, data medium or database, used either for archiving purposes or for the protection of vital and non-replaceable data against loss when the working copy is corrupted. Certain applications automatically generate backup copies of data files, and manage both the current and the previous versions on the hard disk.

Baud

Physical unit for the step speed in signal transmission. Defines the number of transferred signal states per second. With only two states, one baud is equivalent to a transmission rate of 1 bps.

Boot disk

A boot disk is a disk with a "Boot" sector. This can be used to load the operating system from the disk.

Cache

High-speed access buffer for interim storage (buffering) of requested data.

CE marking

Communauté Européene The CE mark confirms compliance of the product with corresponding EC Directives, for example, with the EMC Directive.

CFast card

CFast is a digital storage medium in card form without moving parts. A CFast card uses the SATA protocol and its connectors are not compatible with a classic CompactFlash card.

Chipset

Located on the motherboard, connects the processor with the PCI or PCIe bus and the external interfaces.

Cold restart

A start sequence, starting when the computer is switched on. The system usually performs some basic hardware checks within the cold start sequence, and then loads the operating system from the hard disk to work memory -> boot

COM interface

The COM interface is a serial V.24 interface. The interface is suitable for asynchronous data transfer.

Configuration files

These are files containing data which define the configuration after restart. Examples of such files are CONFIG.SYS, AUTOEXEC.BAT and the registry files .

Configuration software

The configuration software updates the device configuration when new modules are installed . This is done either by copying the configuration files supplied with the module or by manual configuration using the configuration utility.

Controller

Integrated hardware and software controllers that control the functions of certain internal or peripheral devices (for example, the keyboard controller).

Device configuration

The configuration of a PC or programming device contains information on hardware and device options, such as memory configuration, drive types, monitor, network address, etc. The data are stored in a configuration file and enable the operating system to load the correct device drivers and configure the correct device parameters. . If changes are made to the hardware configuration, the user can change entries in the configuration file using the SETUP program. .

Drivers

Program parts of the operating system. They adapt user program data to the specific formats required by I/O devices such as hard disk, printers, and monitors.

EMC directive

Directive concerning **E**lectromagnetic **C**ompatib**l**ity. Compliance is confirmed by the CE symbol and the EC certificate of conformity.

Energy management

The energy management functions of a modern PC allow individual control over the current consumption of vital computer components (e.g. of the monitor, hard disk and CPU), by restricting their activity based on the current system or component load. Energy management is of particular importance for mobile PCs.

Energy options

The energy options can be used to reduce energy consumption of the computer, while keeping it ready for immediate use. This can be configured in Windows by selecting Settings > Control Panel > Energy options.

Enhanced Write Filter

Configurable write filter that allows you to, for example, boot Windows Embedded Standard from write-protected media (e.g., CD-ROM), set write protection for individual partitions, and adapt the file system performance to user requirements (when using memory cards, for example).

ESD Guideline

Guideline for using electrostatic sensitive components.

Ethernet

Local network (bus structure) for text and data communication with a transfer rate of 10/100/1000 Mbps.

Execute Disable Capability

Hardware implementation that prevents mutual memory accesses by programs and applications. It is only effective when all relevant system components, such as processors, operating systems and applications are supported.

Extensible Firmware Interface

Refers to the central interface between the firmware, the individual components of a computer and the operating system. EFI is located logically beneath the operating system and represents the successor to PC BIOS, focusing on 64-bit systems.

File Based Write Filter

Configurable write filter to protect individual files from write access.

Formatting

Basic partitioning of memory space on a magnetic data medium into tracks and segments. Formatting deletes all data on a data medium. All data media must be formatted prior to their first use.

HORM

Hibernate once, resume many is a method for fast booting from a single Hibernate file that only needs to be created once. HORM ensures restoration of a uniform, saved system state when booting. This minimizes write access, for example to a CompactFlash medium, when you start up and shut down Windows Embedded Standard 7.

Hub

A term in network technology. In a network, a device joining communication lines at a central location, providing a common connection to all devices on the network.

Hyper Threading

HT technology (multi-threading) enables the parallel computing of processes. HT is only effective when all relevant system components, such as processors, operating systems and applications are supported.

IGD

Integrated Graphics Device. Graphics interface integrated in the chipset.

Image

This refers to the image, for example, of hard disk partitions saved to a file in order to restore them when necessary.

Intel Active Management Technology

This technology permits the diagnostics, management and remote control of PCs. It is only effective when all relevant system components, such as processors, operating systems and applications are supported.

Intel VT

The Intel Virtualization Technology (IVT) is the implementation of a secure closed environment for applications. Special (visualization) software on a VT-capable processor is required for its use.

Interface

- Physical interconnection (cable) of hardware elements such as PLCs, PCs, programming devices, printers or monitors.
- Interface for interactive software applications.

LAN

Local Area Network: LAN is a local network that consists of a group of computers and other devices that are distributed across a relatively restricted range and are linked with communication cables. The devices connected to a LAN are called nodes. The purpose of networks is the mutual use of files, printers or other resources.

Legacy Boot Device

Conventional drives can be used as USB devices.

License key

The license key represents the electronic license stamp of a license. Siemens provides the license keys for protected software.

License key disk

The license key disk contains the authorizations or license keys required to enable protected SIMATIC software.

Low-voltage directive

EC Product Safety Directive relating to the safety of products which are operated on low voltage (50 V AC to 1000 V AC, 70 V DC to 1500 V DC) and not specified in other directives. Compliance is confirmed by the CE symbol and the EC certificate of conformity.

Module

Modules are plug-in units for PLCs, programming devices or PCs. They are available as local modules, expansion modules, interfaces or mass storage (Mass storage module).

Motherboard

The motherboard is the core of the computer. Here, data are processed and stored, and interfaces and device I/Os are controlled and managed.

Operating system

Generic term which describes all functions for controlling and monitoring user program execution, distribution of system resources to the user programs and the operating mode in cooperation with the hardware (for example, Windows 7 Ultimate).

Pixel

The pixel represents the smallest element that can be reproduced on-screen or on a printer.

Plug&Play

Generally, a reference to the ability of a computer to automatically configure the system for communication with peripheral devices (for example monitors, modems or printers). The user can plug in a peripheral and "play" it at once without manually configuring the system. A Plug&Play PC requires both a BIOS that supports Plug&Play and a Plug&Play expansion card.

POST

Self-test performed by the BIOS after the computer is switched on. Performs a RAM test and a graphics controller test, for example. The system outputs audible signals (beep codes) if the BIOS detects any errors; the relevant message indicating cause of error is output on the screen.

Programmable controller

The programmable controllers of the SIMATIC S5 system consist of a central controller, one or several CPUs and various other modules (for example, I/O modules).

PXE server

A Preboot Execution Environment server is part of a network environment and can provide software to connected computers even before they boot. This can involve operating system installations or servicing tools, for example.

RAL

Restricted Access Location: Installation of the device in a production facility with restricted access, for example, a locked control cabinet.

Recovery function of the USB stick

Contains the tools for configuring hard disks and the Windows operating system.

Reset

Hardware reset: Reset/restart of the PC using a button/switch.

Restart

Warm restart of a computer without switching the power off (Ctrl + Alt + Del)

Restore function of the USB stick

The restore function is used to restore the system partition or the entire hard disk to factory state if the system has crashed. The USB stick contains all the necessary image files and is bootable.

ROM

Read-Only Memory ROM is a read-only memory in which every memory location can be addressed individually. The programs or data are permanently stored and are not lost in the event of a power failure.

S.M.A.R.T

The Self-Monitoring, Analysis and Reporting Technology (SMART or S.M.A.R.T.) is an industry standard integrated in storage media. It makes for permanent monitoring of important parameters and early detection of imminent problems.

SATA

Serial ATA Interface for hard disk drives and optical drives with serial data transmission rates of up to 300 Mbps.

SETUP (BIOS Setup)

A program in which information about the device configuration (that is the configuration of the hardware on the PC/PG) is defined. The device configuration of the PC/PG is preset with defaults. Changes must therefore be entered in the SETUP if a memory expansion, new modules or a new drive are added to the hardware configuration.

SSD (Solid State Drive)

A Solid State Drive is a drive that can be installed like any other drive; it does not contain a rotating disk or other moving parts because only semiconductor memory chips of similar capacity will be used. This design makes SSDs more rugged, provides shorter access times, low energy consumption and rapid data transfer.

STEP 7

Programming software for the creation of user programs for SIMATIC S7 controllers.

Troubleshooting

Error cause, cause analysis, remedy

Trusted Execution Technology

Hardware implementation that allows secured execution of programs and applications. It is only effective when all relevant system components, such as processors, operating systems and applications are supported.

Wake on LAN

Wake on Local area network. This function allows the PC to be started via the LAN interface.

Warm restart

The restart of a computer after a program was aborted. The operating system is loaded and restarted again. The CTRL+ ALT+ DEL hotkey can be used to initiate a warm restart.

Index

A

- Abbreviations, 173, 178
- Adapting
 - Partitioning, 107
- Alarms
 - On the screen, 157
- Antivirus software, 60
- Australia, 112
- Automatic Update, 60

B

- Backup battery, 69
- Backup memory, 131
- Battery monitoring, 69
- BIOS Setup, 150
 - Exit menu, 155
 - Menu layout, 153
- Boot sequence, 157

C

- CAN
 - Base address register, 149
- CE marking, 111
- Certificates, 111
 - Certifications and approvals, 111
- CFast card
 - Interface, 139
 - Removing from external slot, 84
- chkdsk, 166
- Cleaning Agents, 90
- COA label, 27
- Components sensitive to electrostatic charge, 113
- Condensation, 26
- Connecting
 - Network, 54
 - Peripherals, 44
 - Power supply, 53
 - Protective conductor, 45, 46
- Connecting the protective conductor, 46
- Creating an image, 109

D

- Data backup, 109
- Data exchange, 54
- Degree of protection, 31, 130
 - Protection against ingress of solid foreign bodies, 135
 - Protection against water, 135
- Device
 - Opening, 79
 - Switching off, 59
- DiagBase software, 66
- DiagMonitor
 - Temperature monitoring, 67
- DiagMonitor software, 66
- Diagnostics, 66, 66
 - DiagBase software, 66
 - DiagMonitor software, 66
 - Error Messages, 157
- Directive
 - ESD Directive, 113
- Display, 10
- DisplayPort
 - Interface, 140
- Documentation and Drivers, 98
- Drives, 132

E

- Electromagnetic compatibility, 131
- Enable register
 - Watchdog, 148
- Enhanced Write Filter, 70
- ESD, 113
- ESD Directive, 113
- Ethernet, 54
- Ethernet address, 27
- Ethernet interface, 141
- EU Declaration of Conformity, 111
- EFW (Enhanced Write Filter), 70

F

- Factory state, 99
- FBWF (File Based Write Filter), 73
- FCC and ICES, 111

File Based Write Filter, 73
Fire protection covering, 33
Fire protection enclosure, 33
Firewall, 60

I

Industrial Ethernet, 54
Initial commissioning, 58
Installation guidelines, 33
Installation information, 33
Installation of operating system
 Windows, 100
Installing language package, (See MUI)
Integration
 Ethernet, 54
 Industrial Ethernet, 54
Interfaces, 133
 CFast card, 139
 DisplayPort, 140
 USB 2.0, 142
 USB 3.0, 141
Interference emission, 131
IT communication, 54

L

Labeling, 112
 Korea, 112
License key, 99
Limitation of liability, 89

M

Main memory, 131
Marking
 EU Declaration of Conformity, 111
Memory media
 Drives, 132
Memory modules, 131
Monitoring functions, 66
Motherboard, 131
Mounting
 Multi-touch device, 39
 Single-touch device, 35
 with latch fasteners, 36
Mounting clip
 Installing multi-touch device, 39
 Installing single-touch device, 35

Mounting cutout
 Dimensions, 32
 Preparing, 32
MUI, 101
Multi-touch device
 Mounting, 39

N

New Zealand, 112
Note, 33
 General Information, 23
 Installation guidelines, 33
NVRAM, 74

O

On-screen error messages, 157
Opening
 Device, 79
Operating system
 Initial commissioning, 58
 Updates, 109, 109
Operation
 Capacitive multi-touch screen, 63
 Single-touch screen, 62
 Touch screen, 61

P

Package contents, 25
 Checking, 25
Packaging, 25
 Checking, 25
 Removing, 25
Partitioning
 Adapting, 107
 CFast card, 105
 SSD, 105, 106
 Windows 7 Ultimate, 106
 Windows Embedded Standard 7, 105
Ports
 RJ45 Ethernet, 141
Power disconnection, 47
Processor, 131
PROFINET, 146
Protective conductor, 45, 63
 Connecting, 45
Protective conductor connection, 63
Protective measure
 Static electricity, 115

R

Radiation, 20
 High-frequency radiation, 20
 Recovery function, 98
 Repairs, 87
 Resolution, 10
 Restore CD, 103
 Restore function, 98
 Restore function for Windows Embedded Standard, 99

S

Safety information
 Storage, 26
 Transportation, 26
 Scope, 3
 SCU, 152
 Serial number, 27
 Setting up partitions
 Windows 7, 101
 Setup, (BIOS Setup)
 SIMATIC NET, 54
 SIMATIC S7, 54
 Integration, 54
 Single-touch device
 Mounting, 35
 Single-touch screen
 Operating, 62
 SSD
 Partitioning, 105, 106
 Standard mounting position, 29
 Startup, 157
 Static electricity
 Protective measures, 115
 Supply voltage, 48
 System partition, 99
 System resources, 145

T

Temperature monitoring, 67
 TFT technology, 10
 Third-party expansion cards, 167
 Touch screen
 Operation, 61
 Trigger register
 Watchdog, 148

U

Unified Write Filter, 69
 Update,
 Updates
 Application programs and drives, 109
 Operating system, 109, 109
 USB 2.0
 Interface, 142
 USB 3.0
 Interface, 141
 User Account Control, 60
 UWF, 69

V

Ventilation slits, 33

W

Warranty, 19
 Watchdog, 68
 Enable register, 148
 Monitoring function, 68
 Monitoring times, 68
 Trigger register, 148
 Windows
 Installation, 100
 Windows 7 Ultimate
 Data backup, 109
 Partitioning, 106
 Windows Action Center, 60
 Windows Embedded Standard
 Data backup, 109
 Windows Embedded Standard 7
 Setting up partitions, 105
 Windows XP Professional
 Data backup, 109
 Wiring information, 48

