

OMRON

Programmable Terminals

NS Series

NS-series Screen Designer



Machine Monitoring Software

NS-Runtime

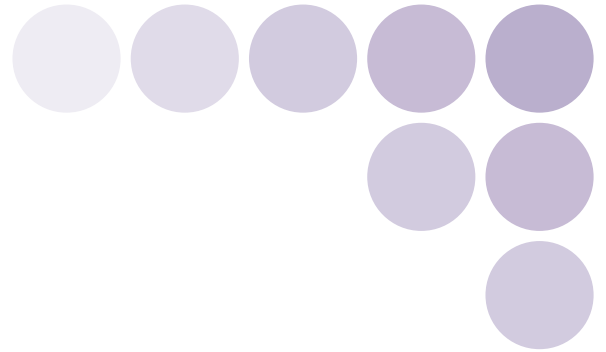

NS

Real Value and Flexible Application

Provides the Functions Sought in New Displays.
This Powerful Lineup Showcases OMRON's Unique Value.

SERIES

New 15-inch Model!



realizing

NS-series Value

What's New

- Even Simpler Equipment Operation with Outstanding Synergy..... **P 6**
- The NS-series PT Is Now Available with a Large 15-inch Display!
- The Expanded Lineup Supports an Even Wider Range of Applications. **P 8**
- The NS15 Can Do All of This. **P 10**
- NS series Supports SYSMAC CJ2.
- Full access to CPU memory and tag access with EtherNet/IP. **P12**
- Greatly Improved Ladder Monitor.
- Enhanced Visibility and Ease of Use. **P14**
- Further Enhancement of Basic Functions. **P16**

Perfect Synergy

Best Match

Demonstrates excellent matching with OMRON control devices. Greatly reduces the cost and effort required to connect all kinds of components, such as PLCs. Provides a wide variety of useful functional aspects of the same manufacturer.

- Eliminates Programming and Screen Designing..... P18
- SAP Library..... P19
- Single Port Multi Access (SPMA)..... P20
- Ladder Monitor..... P20
- PLC Data Trace..... P21
- PLC Troubleshooter..... P21
- Direct Connection to Temperature Controllers..... P21
- Face Plate Auto-Builder for NS..... P22
- 260,000-color Video Display..... P22

Simple Screen Designing

Easy-to-use Software

The CX-Designer is so easy-to-use that anyone can master it, without even designing screens and ladder programs. You can create the desired screens quickly and with OMRON's integrated development environment, you can dramatically reduce the time required to design screens.

- User-friendly Screen Creation..... P24
- Reading the Symbol Table..... P25
- Reading Another Project's Screens and Objects..... P26
- Reading CAD Files..... P26
- Integrated Simulation with the PLC Ladder Program..... P26
- Editing of Multiple Objects..... P27
- Editing of Overlapping Objects..... P27
- Programming with Symbols..... P27

Complete Functionality

Plenty of Basic Functions

The basic functions desired in new displays have been greatly improved. In addition to making the displays as easy-to-use as possible, a variety of useful functions that can precisely meet the customers' needs have been built into the displays.

- Multi-language Support..... P28
- Beautiful Screens..... P29
- Huge 60-MB Image Memory..... P29
- Easier Design of Machine Error Screens..... P30
- Easy-to-Use Multifunction Objects..... P30
- Plentiful Graphing Functions..... P31
- Screen Data Security Functions..... P32
- User Security Functions..... P32
- FTP Function..... P32
- Connect! Expand! Feel the NS Series, the power of networking..... P34

NS-Runtime

Achieve machine/line monitoring and data logging on your office computer. **P36**

What's New

Compatibility

Screen Design Software

Basic Functions

NS-Runtime

Specifications

NS Series Lineup

This powerful lineup showcases OMRON's unique value. Choose from 3 types to match your application and requirements.

NS Series Plentiful screen variations and diverse functions allow use in a wide variety of applications.

Standard Models

15 inches

NS15-TX01 Color TFT



- USB Slave
- USB Master
- Ethernet
- RS-232C x 2
- Controller Link
- Ladder Monitor
- Video (HDC input only)
- Memory Card
- RS-422A/485
- Brightness adjustment
- RGB output

- 32,768 colors ●XGA 1,024 x 768 pixels
- Screen memory size: 60 MB

- Analog touch panel method
- Silver or black models are available.



NEW

For details, refer to *What's New* on page 8.

5.7 inches

NS5-MQ Monochrome STN



- 16 monochrome gradations
- QVGA 320 x 240 pixels
- Screen memory size: 60 MB

NS5-SQ Color STN



- 4,096 colors ●QVGA 320 x 240 pixels
- Screen memory size: 60 MB

NS5-TQ Color TFT



- 32,768 colors ●QVGA 320 x 240 pixels
- Screen memory size: 60 MB

8.4 inches

NS8-TV Color TFT

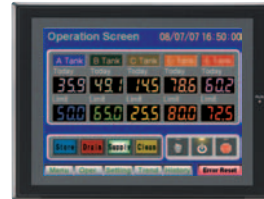

- 32,768 colors ●VGA 640 x 480 pixels
- Screen memory size: 60 MB

10.4 inches

NS10-TV Color TFT



- 32,768 colors ●VGA 640 x 480 pixels
- Screen memory size: 60 MB

12.1 inches

NS12-TS Color TFT



- 32,768 colors ●SVGA 800 x 600 pixels
- Screen memory size: 60 MB

NS-Runtime

NS-NSRCL
This software enables PLC communications from a personal computer by manipulating PT screens created using the CX-Designer.



Page 36

Optional Products NS-series functions, such as image processing and networking, have been expanded.



Video Input Unit
NS-CA001
●NTSC/PAL video inputs (4 channels)



RGB/Video Input Unit
NS-CA002
●NTSC/PAL (2 channels)
●RGB input (1 channel)



Controller Link Interface Unit
NS-CLK21



RS-232C/RS-422A Conversion Unit
NS-AL002
●Transmission distance: 500 m max.



Communications Cable
XW2Z-S002



USB relay cable (IP65 oil-resistant type)
NS-USBEXT-1M

SYSMAC One NSJ Series PT is unified with the Controller into one package to greatly help standardize equipment and reduce size.

Integrated Controller Models

5.7 inches

NSJ5-SQ□□-M3D/-G5D Color STN



- (Display Section)
- 4,096 colors
 - QVGA 320 x 240 pixels
 - Screen memory size: 20 MB (Controller Section)
- M3D**
- I/O points: 640
 - Program capacity: 20K steps
 - Data Memory: 32K words
- G5D**
- I/O points: 1,280
 - Program capacity: 60K steps
 - Data Memory: 128K words

NSJ5-TQ□□-M3D/-G5D Color TFT



- (Display Section)
- 32,768 colors
 - QVGA 320 x 240 pixels
 - Screen memory size: 20 MB (Controller Section)
- M3D**
- I/O points: 640
 - Program capacity: 20K steps
 - Data Memory: 32K words
- G5D**
- I/O points: 1,280
 - Program capacity: 60K steps
 - Data Memory: 128K words

8.4 inches

NSJ8-TV□□-M3D/-G5D Color TFT



- (Display Section)
- 32,768 colors
 - VGA 640 x 480 pixels
 - Screen memory size: 60 MB (Controller Section)
- M3D**
- I/O points: 640
 - Program capacity: 20K steps
 - Data Memory: 32K words
- G5D**
- I/O points: 1,280
 - Program capacity: 60K steps
 - Data Memory: 128K words

10.4 inches

NSJ10-TV□□-G5D Color TFT



- (Display Section)
- 32,768 colors
 - VGA 640 x 480 pixels
 - Screen memory size: 60 MB (Controller Section)
- I/O points: 1,280
 - Program capacity: 60K steps
 - Data Memory: 128K words

12.1 inches

NSJ12-TS□□-G5D Color TFT



- (Display Section)
- 32,768 colors
 - SVGA 800 x 600 pixels
 - Screen memory size: 60 MB (Controller Section)
- I/O points: 1,280
 - Program capacity: 60K steps
 - Data Memory: 128K words

NSH Series A hand-held version of the NS5 is now available to perform operations at the production site.

Hand-held Models

5.7 inches



NSH5-SQR
Color STN

- Equipped with a red switch for an emergency stop input.
- 4,096 colors
- QVGA 320 x 240 pixels
- Emergency stop (3 inputs)



NSH5-SQG
Color STN

- Equipped with a gray switch for a stop input.
- 4,096 colors
- QVGA 320 x 240 pixels
- Emergency stop (3 inputs)

Hand-held PT Cable



Note: For details on the NSJ-series Controllers, refer to the NSJ-series Programmable Controllers Catalog (Cat. No. V406).

What's New

Compatibility

Screen Design Software

Basic Functions

NS-Runtime

Specifications

What's New

Even Simpler Equipment Operation with Outstanding Synergy

Quick Screen Changes

Improved system programming greatly enhances screen display speed. The speed is up to 30% faster than system version 7.0. All models from 5.7 to 15 inches feature faster display for better screen operation.

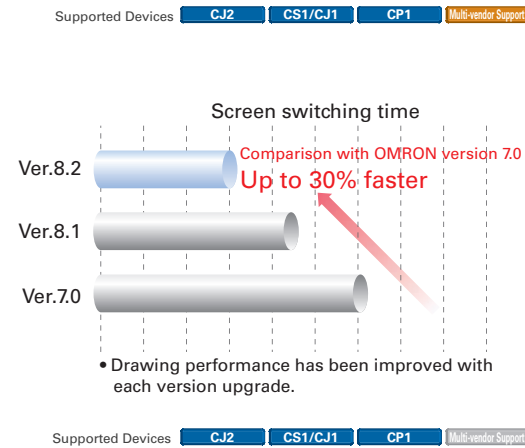

Transfer of Ladder Programs and Screens without Changing the USB Cable Connection

Easier Debugging and Maintenance

Easy Transfer and Editing of Screens and Ladder Programs Using USB

Transfer ladder program data to the PLC via the PT simply by connecting a computer to the USB port on the PT. Transfer ladder data and perform online editing using USB via the PT even for a PLC that does not have a USB port.

PLC Connection via PT

Design and Debugging Example

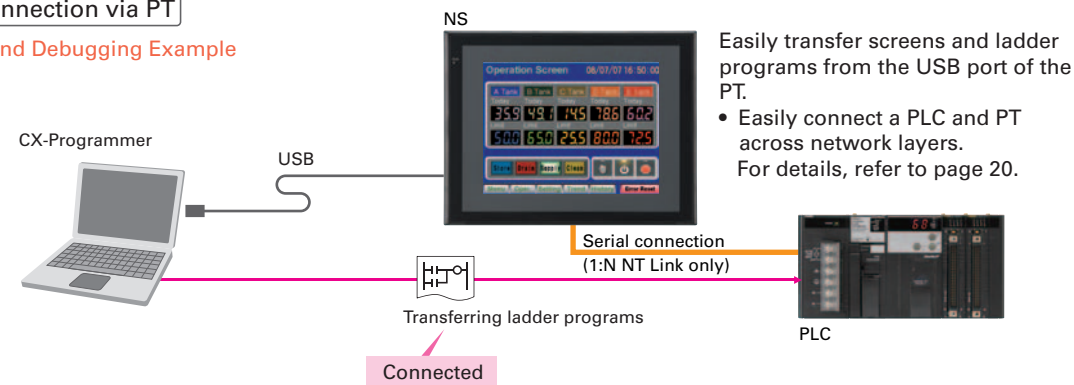

Startup and Maintenance Example

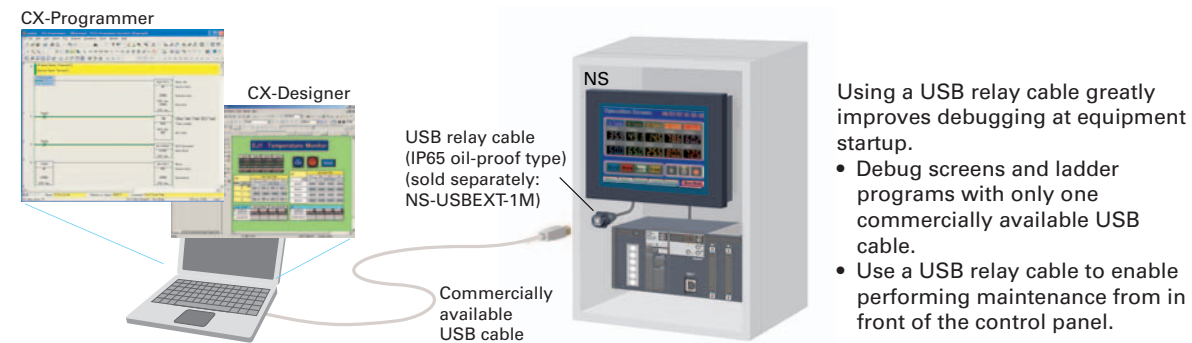

PT Connection via PLC

If a CJ-series PLC is used, screens can be transferred to the PT by connecting the computer and the PLC using a USB cable. Screens can be transferred through the PLC simply by setting the communications path to USB between the computer and the PLC in the transfer settings for the CX-Designer.

Note: CX-Programmer version 8.2 and higher support automatic online connection via the PT. NS system version 8.2 or higher is required.

Easy Automatic Connection

PLC Connection via PT

A search is automatically made for the PLCs connected to the PT and the results are displayed using the automatic online connection function in the CX-Programmer. Just select a PLC from the list to connect. This function is also supported for PLCs over network layers.

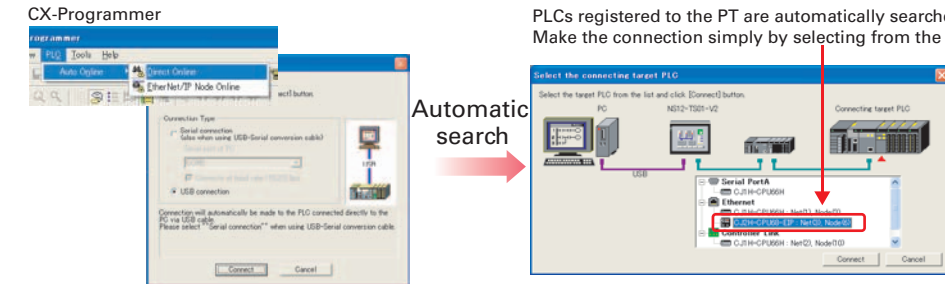

Note: CX-Programmer version 8.2 and higher support automatic online connection via the PT. NS system version 8.2 or higher is required.

Supported Devices: CJ2, CS1/CJ1, CP1, Multi-vendor Support

Program-free, Macro-free

Easy Data Exchange between the PLC and Components

Easy Data Exchange

For example, temperature controller alarm values can be transferred to the DM Area of the PLC's CPU Unit. No communications programming or macros are required.

Multi-vendor Support

Devices from multiple vendors are supported. Data can be easily exchanged with PLCs from other companies and Modbus devices.

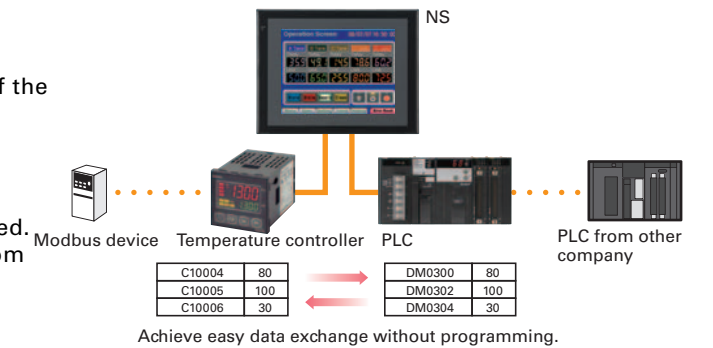

Easy Settings

To make the settings, simply specify the device and addresses of the transfer source and transfer destination in the CX-Designer. Settings can be made using the same procedure as for setting the addresses for normal components.

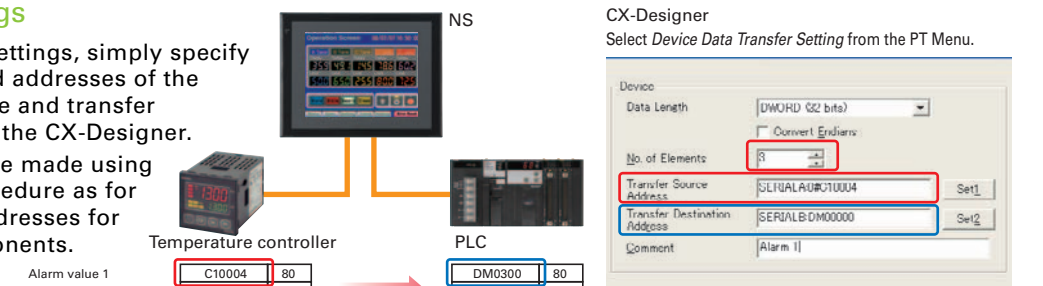

Easier Operation when Combining SAP Library Objects

SAP data can also be exchanged. SAP data can be exchanged by checking the address of the SAP data in the dialog box of the SAP object pasted in the CX-Designer and specifying that address as the transfer source address.

Note 1: EtherNet/IP tags are not supported. **Note 2:** CX-Designer version 3.1 or higher is required. NS system version 8.2 or higher is required.

Easy Connection to the CP1E

Note: NS system version 8.2 or higher is required.

What's New

The NS-series PT Is Now Available with a Large 15-inch Display! The Expanded Lineup Supports an Even Wider Range of Applications.

15 Inches XGA 1,024 x 768 Pixels, Analog Touch Panel
NS15-TX01



Both Stylish Silver and Sleek Black Models Are Available

A Large Display and High Resolution Provide... *Greater Visibility and Easy Operation*

A 15-inch XGA display provides even greater visual expressions. The display size is 1.5 times larger and the number of pixels is 1.6 times greater than the NS12.

With the Ladder Monitor, ladder diagrams can be displayed on the full screen (1,024 x 768 pixels), allowing a program segment of up to 22 rows and 21 columns to be displayed.

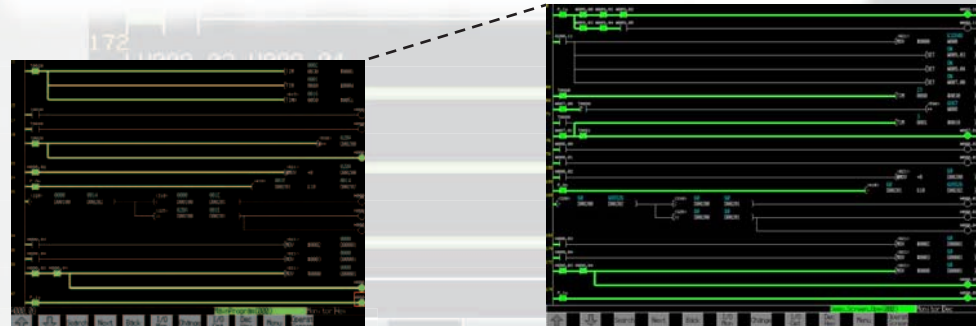

NS12
17 rows x 16 columns max.
SVGA (800 x 600 pixels)

NS15
22 rows x 21 columns max.
XGA (1,024 x 768 pixels)

Using an analog touch panel enables even more detailed operations and inputs.

Background images are actual size.

Large-screen Display Enabled!

Analog RGB Output

Standard Feature

The NS15 screen (XGA) can be displayed on an on-site display that has RGB inputs.

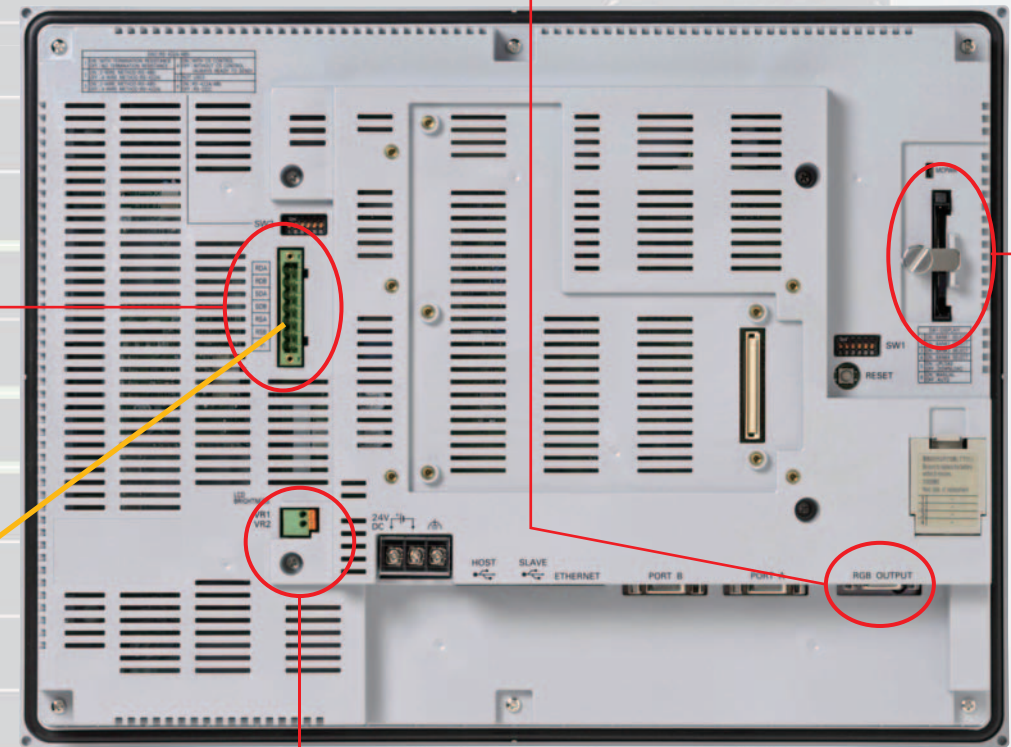
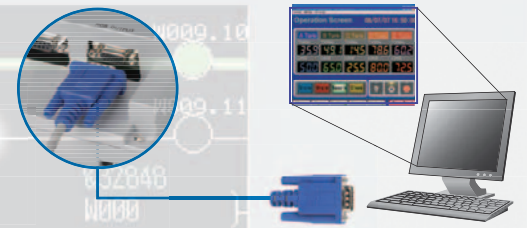

For Use in Dark Places!

A Connector for Brightness Adjustment

Standard Feature

The brightness can be lowered in dark places. A potentiometer (variable resistor) can be connected to this connector to adjust the brightness according to changes in resistance.

Recommended resistance: 0 to 50 kΩ (minimum brightness: 15 cd/m²)
Conforms to LR and NK standards when used with recommended cable length (AWG10 to AWG26, 2 m max.).



Easy to Use!

Rear-panel Memory Card Interface

Standard Feature

A Memory Card interface is provided on the rear panel, making it easier to insert and remove the Memory Card.



No Conversion Unit Required.

RS-422A/485 Serial Interface

Standard Feature

An RS-422A/485 serial interface is provided as a standard feature, enabling connection with no RS-232C/RS-422A Conversion Adapter.

Note: Either RS-232C serial port B or the RS-422A/485 serial interface can be used, but not both. The selection is made with a DIP switch setting.

Continued.

What's New

Compatibility

Screen Design Software

Basic Functions

NS-Runtime

Specifications

The NS15 Can Do All of This.

External Function Keys Enable...

Standard Feature

Simultaneous Two-point Pressing

Contacts can be allocated to external function keys. This makes it possible, for example, to support applications which will not operate unless two points are pressed simultaneously.

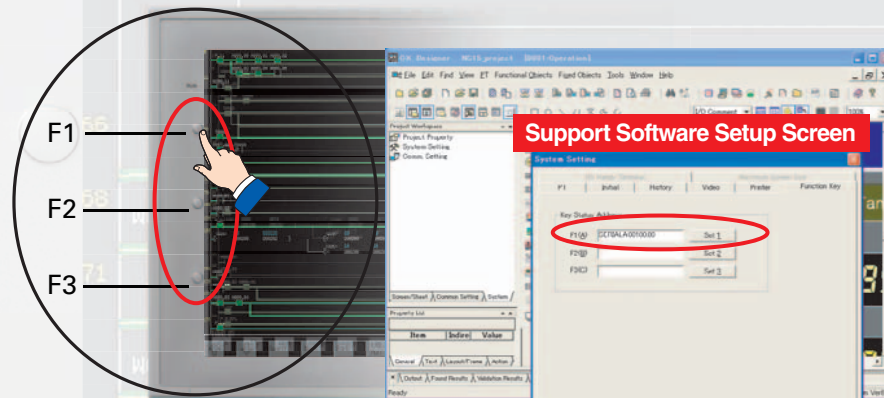

Addresses can be easily allocated to function keys using Support Software.

Expansion Units

Previous NS-series options can still be used. The following Units can be mounted to the expansion bus interface.

Connect OMRON FZ3-series Vision Sensors



RGB Video Input Unit: NS-CA002
 ● Analog RGB input terminals can be used to display XGA signals from a personal computer.
 Note: The NS-CA002 video input function cannot be used with the NS15.
 Note: The NS-CA001 cannot be used.



Controller Link Interface Unit: NS-CLK21
 ● A Controller Link connection can be used.



RS-232C/RS-422A Conversion Unit: NS-AL002
 ● Communications distance: 500 m max.
 ● In addition to the RS-422A/485 serial interface which is supported as a standard feature on the NS15, the Conversion Unit can be used as before. This feature can be used in situations where two RS-422A/485 systems are employed.

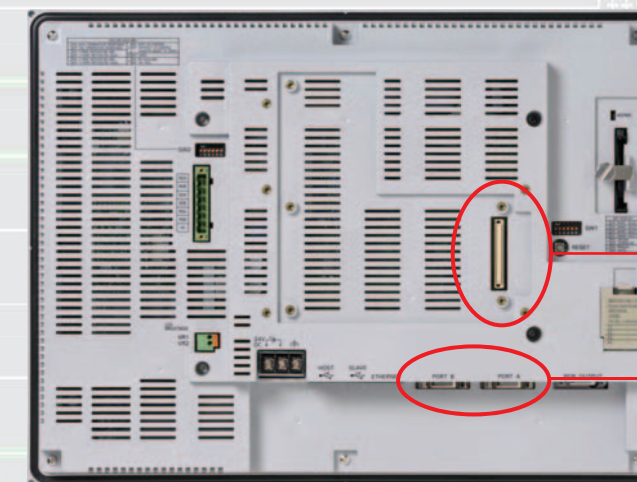

Automatic Screen Enlargement Is Supported During Conversion to...

Greatly Reduce Revisions for Each Screen

Standard Feature

Not only can legacy NS5/8/10/12 screen data be reused, but, for example, objects can be automatically enlarged to match the screen size when converting to the NS15. This can greatly reduce the time involved in modifying screens. Automatic enlargement is also enabled when converting between earlier models, such as from the NS5 to the NS8, NS10, or NS12. In addition, NS-Runtime screens can now be converted to NS-series PT screens.

NS12 (800 x 600 pixels)

NS15 (1,024 x 768 pixels)



Screen objects are automatically enlarged.

Note: Font sizes must be adjusted manually.

Ethernet Port Included as a Standard Feature.

Compatible with the SYSMAC CJ2. Full Access to CPU Memory. EtherNet/IP Support.

An Ethernet port is included as a Standard Feature. In addition to the existing FINS communications, the next-generation FA network EtherNet/IP is now supported.

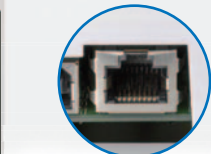

NS-series Ethernet port

Note: The NS15 supports Ethernet as a Standard Feature.

Details on CJ2 compatibility



What's New

NS series Supports SYSMAC CJ2. Full access to CPU memory and tag access with EtherNet/IP.

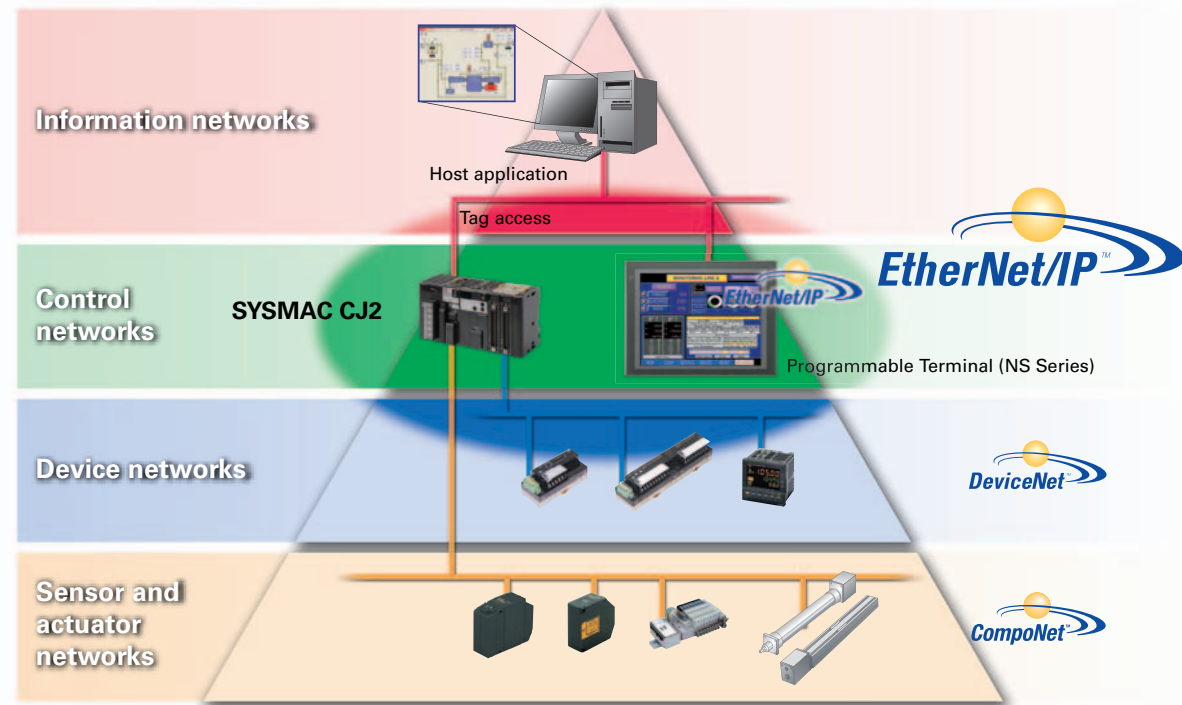

What is tag access with EtherNet/IP?

A tag is a name given to an address. Tags are managed in the CJ2 CPU Unit, where they are defined as network symbols. The common user-defined tag names are used from Programmable Terminals and host applications to access memory in a CJ2 CPU Unit without knowing the physical address.

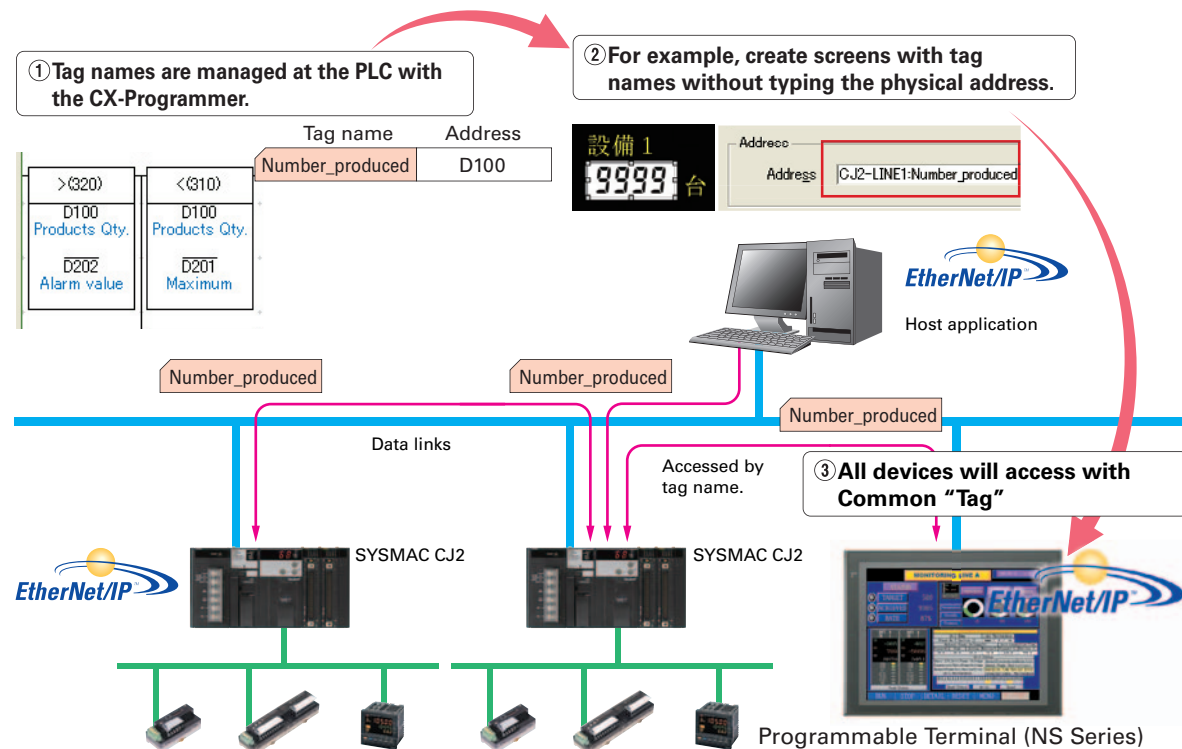

The PLC, PT, and host applications can be designed using tag names. *Parallel development shortens design time.*

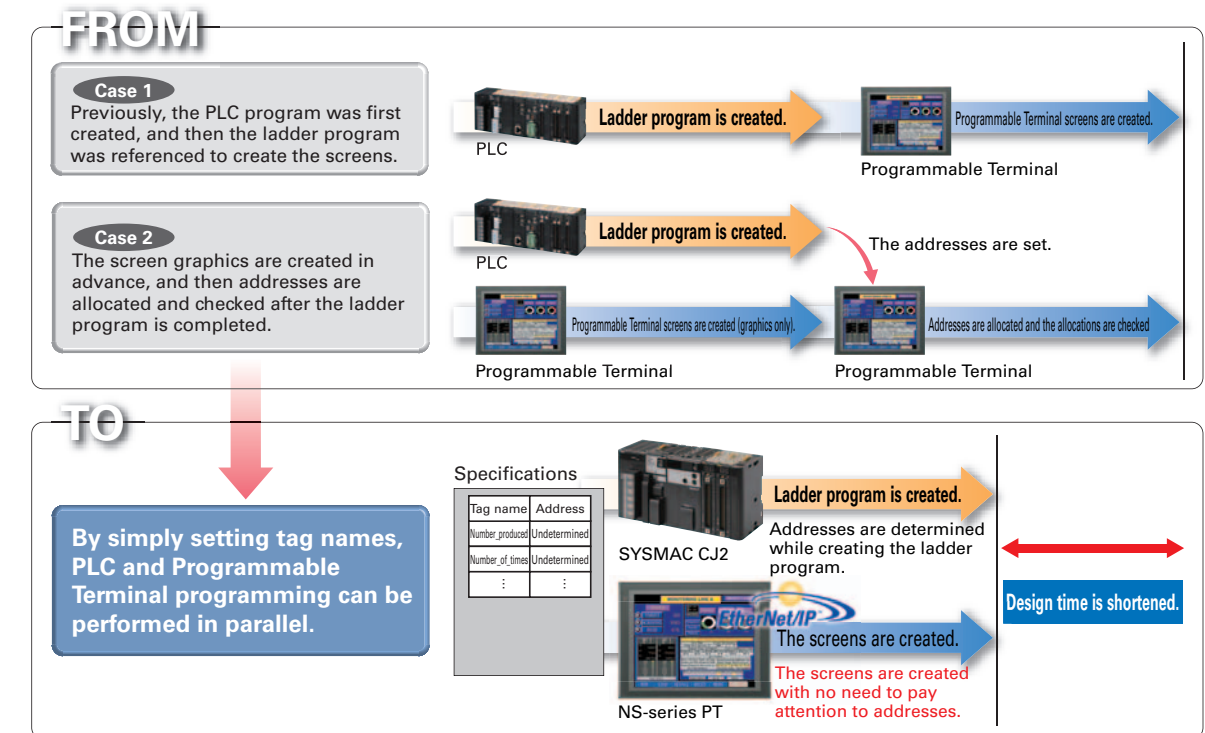

Minimize side effect of address changes. *So Machine Modifications Go Smoothly*

Previously, a change in the address of one location affected a variety of devices and time was required to fix this range of changes and check operation. With the CJ2 CPU Units, it is possible to access memory with tags, so the PT and host application are not affected even if the address of data in the PLC is changed.

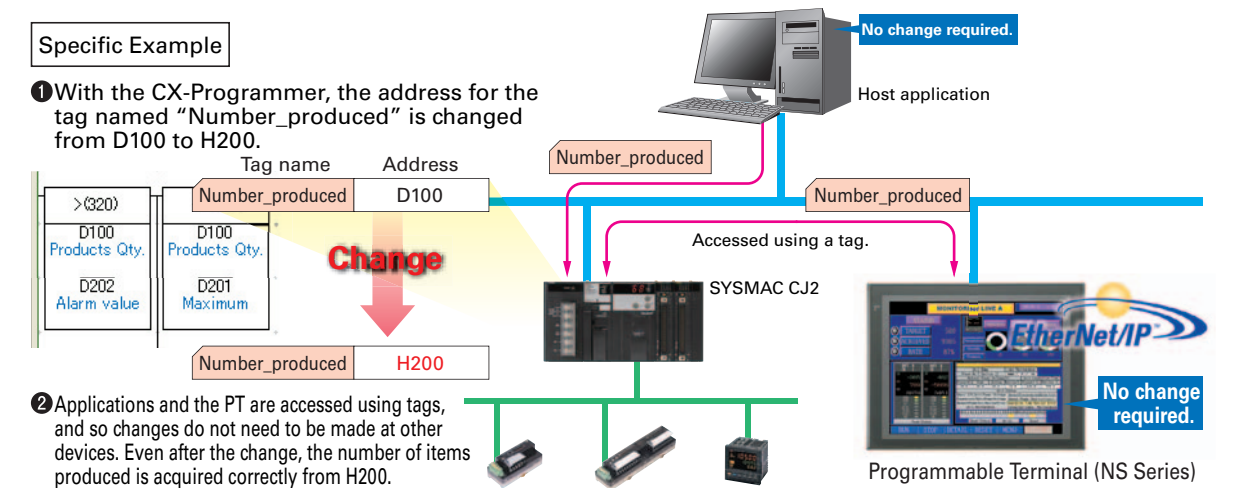

What's New
Compatibility
Screen Design Software
Basic Functions
NS-Runtime
Specifications

Note: Operation is not supported for a connection with a CP1E PLC.

Greatly Improved Ladder Monitor. Thoroughly focused on Visibility and Ease of Use.

Standard Feature
(See note.)

Note: Not supported for the 5.7-inch model.

The Ladder Diagram can be fully displayed on the entire screen,
so it is easier to see and work.

The ability to change the color and size in which the Ladder Monitor is displayed greatly improves visibility. The ladder diagram can be displayed on the entire screen (800 x 600 dots) even for the NS12 with a maximum display of 17 rows and 16 columns of a ladder diagram.

The ladder diagram is easy to see display in black and green.

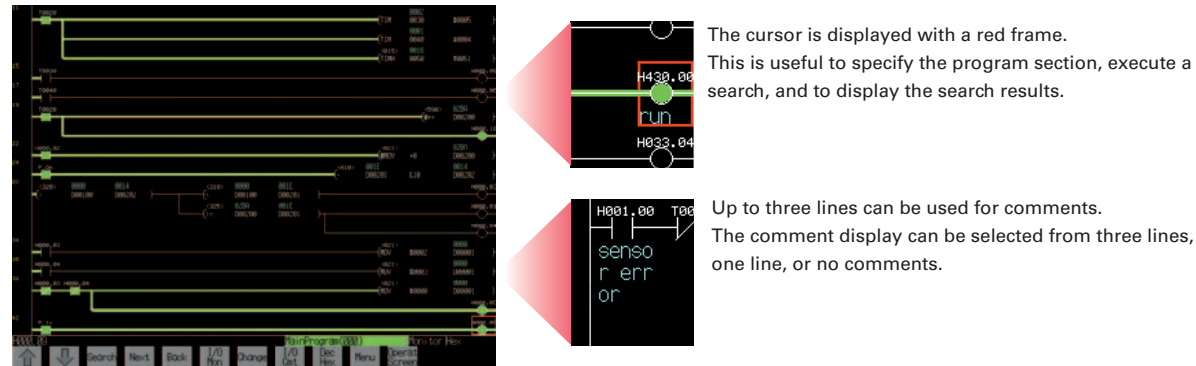

I/O comments can be read directly from the PLC in a single operation,
so no extra work to show I/O comments.

Read I/O comments directly from the PLC. I/O comments do not have to be stored in a Memory Card.

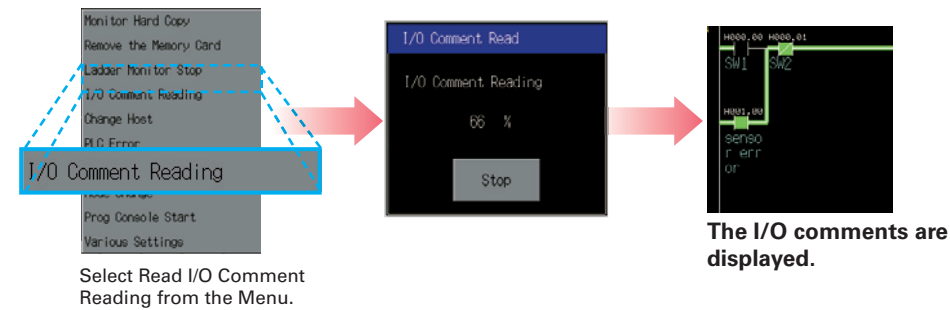

Automatically jumping from the alarm message
Easy checking the alarm bit and shortens searching time.

When an alarm occurs, touch the message to automatically search for the alarm bit (output bit) for the alarm. This enables you to quickly check the alarm address and investigate why the bit turned ON.

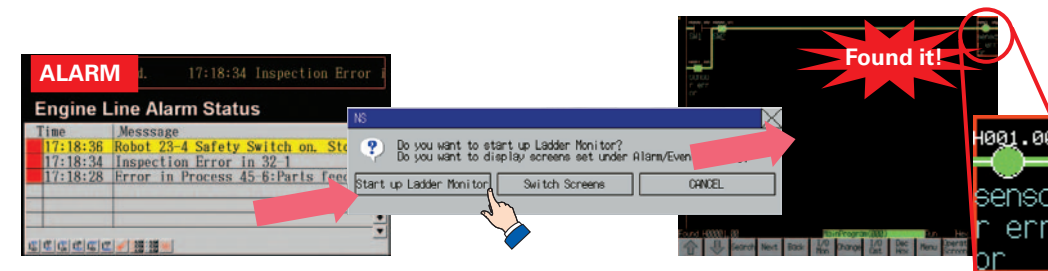

"Find Back", "Find Next", CX-Programmer useful Function Also Supported by the NS-series.
Reduced Time to Investigate Which Output or Input Is Causing the Problem

Function	Operation with NS-series PT.	CX-Programmer
Find the address at specified by the cursor.	Next	N Key
Find the output from the input bit or find the input bit from the output at the cursor.	Double-click	Space Key
Return to the previous search position.	Back	B Key

For example, easily search for the cause using steps 1 to 6 as shown in the following figure.

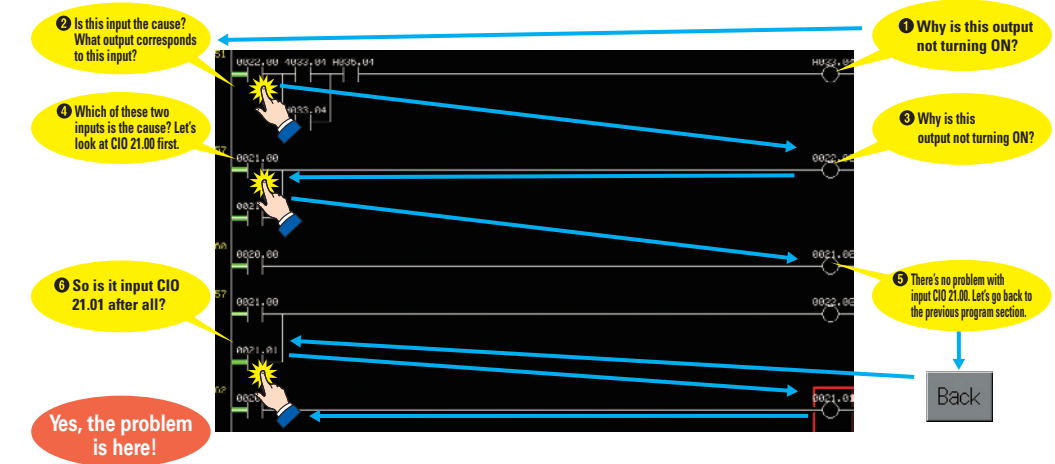

Force-setting and force-resetting are possible,
so conditions can be established as required.

Locations that have been force-set are displayed in pink and can be checked at a glance.

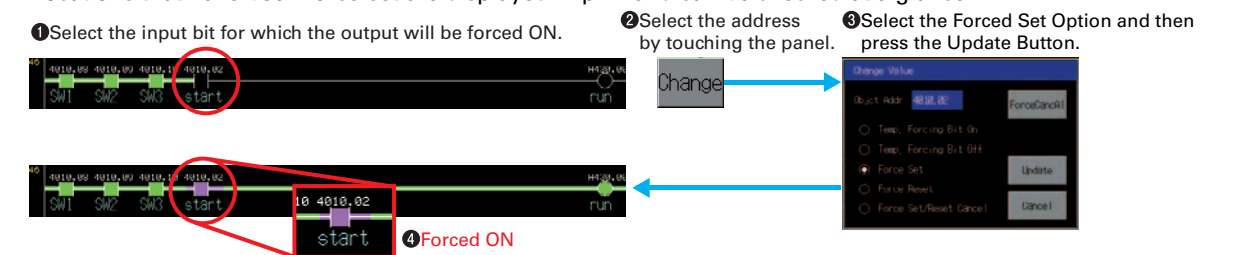

Minor changes in values of timers or counters can be made without Support Software.

Check and Change I/O While You View the Ladder Diagram on the I/O Monitor

Display and change the present value by specifying the address. It is also possible to force-set/reset bits with the I/O monitor.

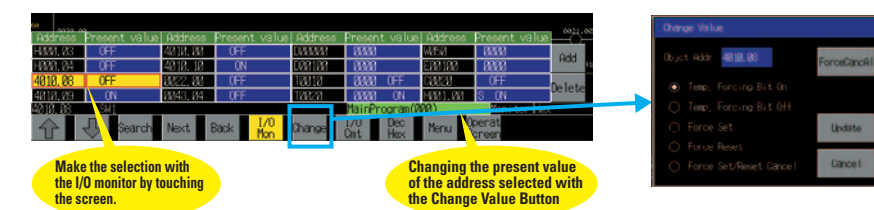

Further Enhanced Basic Functions

Monitor and Record Input Operations on the Control Panel Supported Devices CJ2 CS1/CJ1 CP1 Multi-vendor Support

What Was Touched When? can be recorded with Operating log.

Functionality has been improved with the addition of a log to record operators' use of the panels. It is now possible to record and display the time, date, and operation details for buttons (i.e., hardware switches) pressed on the control panel in addition to operations on the touch panel. The operation log can be saved in a CSV file on a Memory Card mounted in the NS-series PT.

Switch directly from the user screen to the log operation display screen.

Multiple operation log files can be saved on a Memory Card with date and time data.

Operat_080520_173000.csv
Operat_080521_173000.csv
Operat_080522_173000.csv

Memory Card

A comment of up to 32 characters can be set and displayed for each operation to provide easy-to-understand information about what type of operation was performed.

The files can be opened in Excel.

For example, with a control panel comprised of the NS-series PT, hardware switches, and an emergency stop button, you can even record and display operation of the emergency stop button.

Multi-vendor Support

In addition to the previously supported models, it is possible to connect to Mitsubishi Q-series PLCs and QnA-series PLCs, Siemens PLCs, and Rockwell PLCs. Connection can also be made with the RTU mode of Modbus devices. And connection is possible to the FA-M3(R) Series of PLCs from Yokogawa Electric. For details on the connection methods, refer to the list of connectable models on page 52.

■PLC				
Manufacturer	Series	CPU	Connection form	
Mitsubishi Electric	A Series	A1SHCPU	1:1	
		A2USCPU		
		A2USHCPU-S1		
		A2APU		
	FX Series	FX0N	1:1	
		FX1S		
		FX1N		
		FX1NC		
		FX2N		
		FX3UC		
	Q/QnA Series	Q00CPU	1:1	
		Q01CPU		
		Q00CPU		
		Q01CPU		
		Q00JCPU		
		Q02CPU		
		Q02HCPU		1:N
		Q06HCPU		
		Q12HCPU		
		Q25HCPU		
Q2ASCPU				
Q2ASCPU-S1				
Q2ASHCPU				
Q2ASHCPU-S1				

■PLC			
Manufacturer	Series	CPU	Connection form
Yokogawa Electric	FA-M3(R) Series	F3SC23-1F	1:1
		F3SP21-0N	
		F3SP28-3S	
		F3SP58-6S	
		F3SP67-6S	
Siemens	S7-300 Series	313CPU	1:1
		SCPU315-2DP	
		CPU317-2PD/DP	
Rockwell (Allen-Bradley)	SLC500	SLC5/03	1:1
		SLC5/04	
		SLC5/05	
	MicroLogix	MicroLogix1500	1:1
ControlLogix	Logix5555	1:1	
CompactLogix	1769-31	1:1	
PLC-5	PLC-5/20	1:1	

■Motion Controller			
Manufacturer	Series	CPU	Connection form
Yaskawa Electric	MP900 Series	MP920	1:1
	MP2000 Series	MP2200	1:N

■Inverters		
Manufacturer	Series	Connection form
OMRON	3G3MV (Varispeed)	1:N
	3G3JV (Varispeed)	

■Modbus Devices
Connection is now possible with Modbus devices (RTU mode).

Further Improvement with Groups of Beautiful Objects Supported Devices CJ2 CS1/CJ1 CP1 Multi-vendor Support

More-beautiful Screen

Greatly Enhanced Libraries for Beautiful Lamps and Switches

A selection of over 1,000 beautiful objects is provided. With these objects, you can improve the appearance of your equipment.



Easy Printing with PictBridge

The screens of all models from the 5.7 inches to 15 inches can print to a printer.

Using a printer that is compatible with PictBridge, you can print with one USB cable.

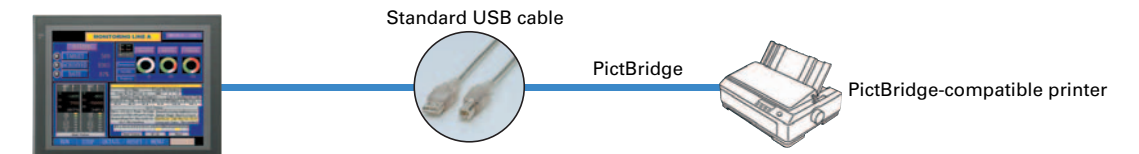

Note: Refer to page 48 for recommended PictBridge-compatible printers.

Greater NS 5 Screen Data Capacity

Now, even in the 5.7-inch class have 60 MB of screen data capacity as a standard feature and also enhanced main memory.

You can make many screens with images and don't have to worry about the memory capacity. The internal memory is also increased, PictBridge is supported even for the NS5 Series, and capability is provided with EtherNet/IP for the CJ2. Legacy screen data for the NS5-Q0(B)-V2 can be used without alteration.

New Model in the NS5 Series

NS5-Q1(B)-V2

Note: For the list of models, refer to the Ordering Information on page 44.

■Supported Models ○ : Supported — : Not supported					
Series	Model	Screen capacity	Connection with CJ2		PictBridge
			Connection with CJ2 #1	EtherNet/IP connection #2	
NS5	NS5-Q0(B)-V2 *3	20MB	○	—	—
	NS5-Q1(B)-V2	60MB	○	○	○
NS8/10/12	NS12/10/8-V2	60MB	○	○	○

*1.As always, any model in the NS5 Series can perform serial communications, such as NT link and host link, or address communications with Ethernet (FINS).

*2.For tag communications with Ethernet connection to the CJ2.

*3.Unsupported items cannot be used even if this model has been upgraded to system version 8.0 or higher.

Best Match

Best Match with OMRON Products, Eliminates Programming and Screen Designing

The Smart Active Parts (SAP Library) for the NS Series makes it easy to connect to OMRON PLCs and components, without creating ladder programs and screen data. OMRON provides a development environment that requires with no programming and no screen designing.

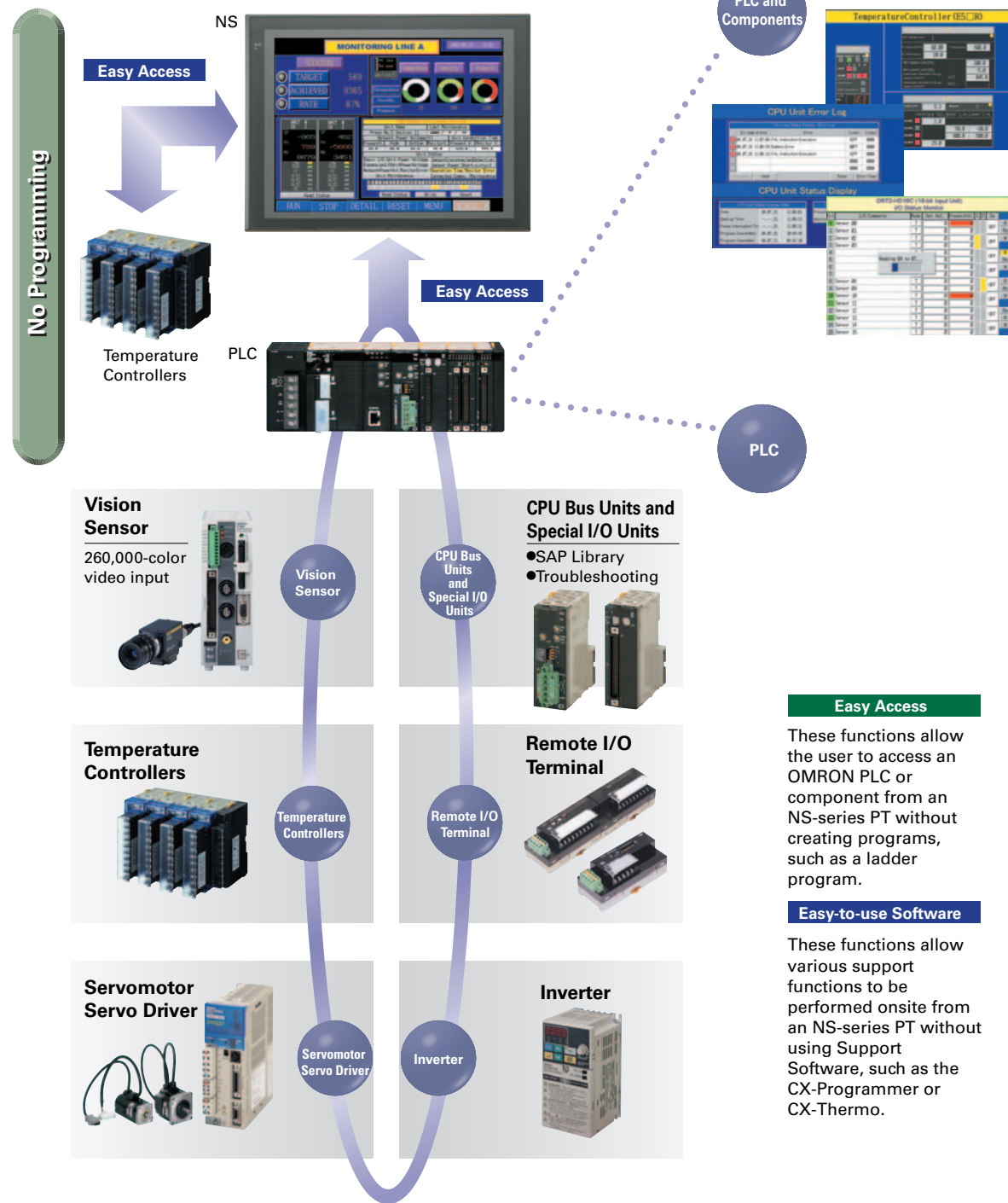

No Screen Designing

PLC and Components

Easy-to-use Software

No Programming

Vision Sensor
260,000-color video input

CPU Bus Units and Special I/O Units
●SAP Library
●Troubleshooting

Temperature Controllers

Remote I/O Terminal

Servomotor Servo Driver

Inverter

Easy Access

These functions allow the user to access an OMRON PLC or component from an NS-series PT without creating programs, such as a ladder program.

Easy-to-use Software

These functions allow various support functions to be performed onsite from an NS-series PT without using Support Software, such as the CX-Programmer or CX-Thermo.

Smart Active Parts (SAP Library)

Easy Access

Standard Feature

Dramatically reduces the effort required to create ladder programming and screens.

More than 3,000 Library parts (Smart Active Parts) are available, which can directly access OMRON PLCs and components. The objects can just be pasted from the Smart Active Parts (SAP Library) Library to the screen; it is completely unnecessary to create screens and ladder programming.

The Temperature Controller's setting and monitor screens are completed in no time.

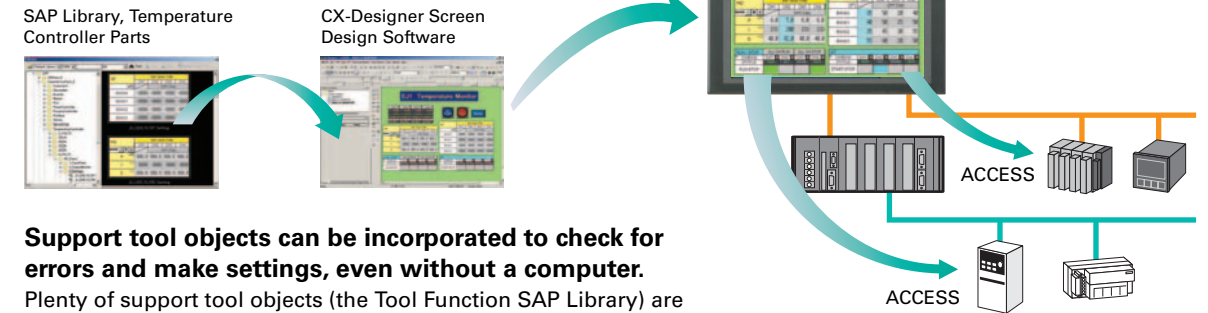

Support tool objects can be incorporated to check for errors and make settings, even without a computer.

Plenty of support tool objects (the Tool Function SAP Library) are available, which can be easily incorporate support tool functions in the NS-series PT. Just paste the support tool objects in the screen to check for errors and make settings, even without a computer.

Example screens using support tool objects (Tool Function SAP Library)

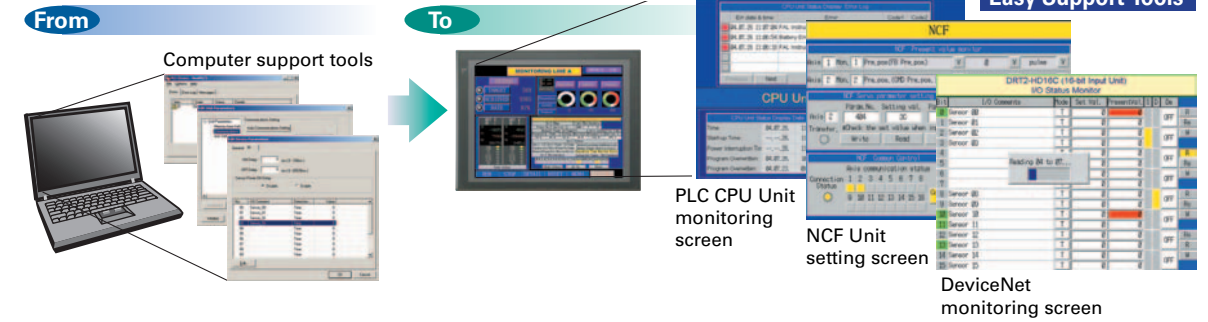

CPU Bus Unit and Special I/O Unit Troubleshooting Can Be Also Performed with the SAP Library.

Easy Support Tools

A Troubleshooter SAP Library is available to troubleshoot each Unit in the PLC. When an error occurs in a Unit, the Troubleshooter SAP Library provides an easy-to-understand explanation of the cause of the error as well as the countermeasures.

Troubleshooter SAP for a Position Control Unit

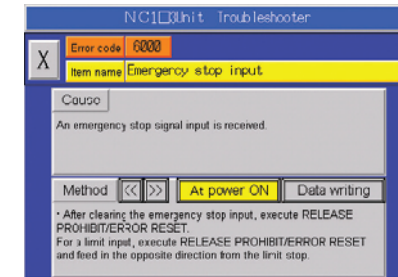

Troubleshooter SAP for Basic I/O Unit

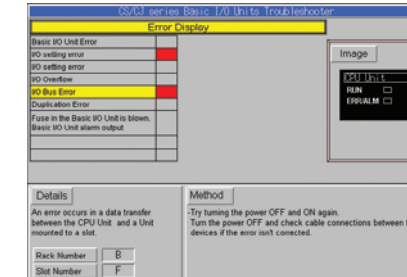

The Troubleshooter SAP Library is included as a standard feature for the CX-One and CX-Designer. For details, refer to page 56. Successive development for Ethernet Units and MC Units is planned for the future.

What's New

Compatibility

Screen Design Software

Basic Functions

NS-RunTime

Specifications

Single Port Multi Access (SPMA)

Easy Access

Standard Feature

The ladder program and screen data can be transferred from a single port!

The ladder program can be transferred through the PLC and the PT's screen data can also be transferred, all while the computer remains connected to the PT's port (such as a USB port).

The PT can transfer data over network levels by the following routes.

Computer (Serial/USB) → NS-series PT (Ethernet) → PLC (Ethernet or Controller Link) → PLC

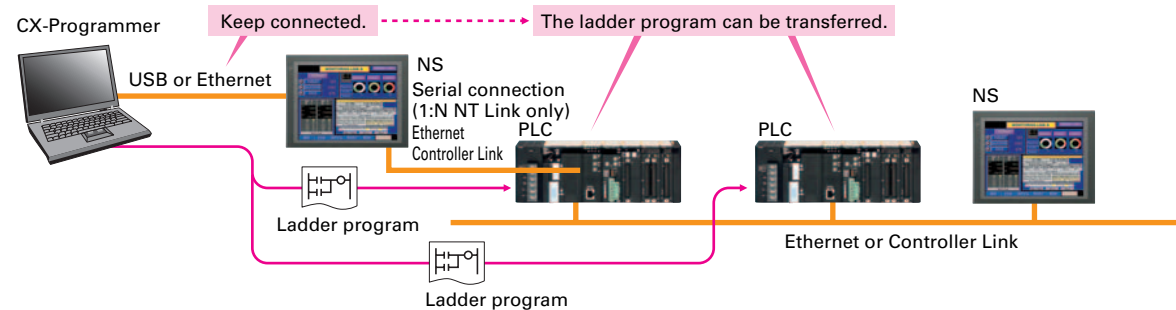

SPMA significantly improves maintenance efficiency when the NS-series PT and PLC are some distance apart.

Computer (Serial) → PLC (Ethernet or Controller Link) → NS-series PT

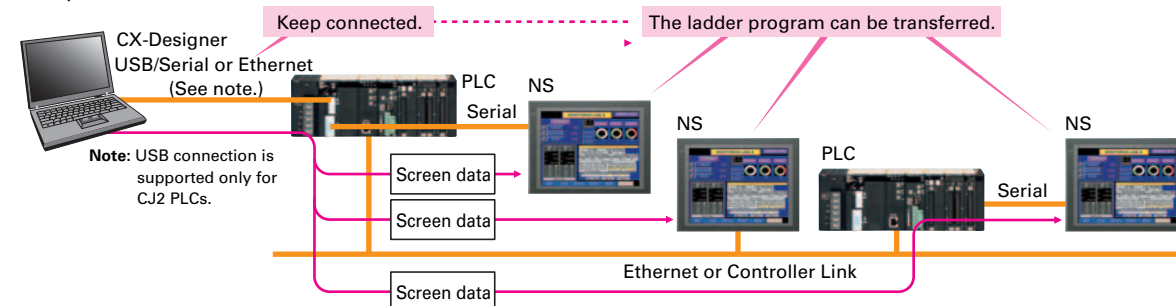

Note: SPMA can be used in CS/CJ-series PLCs with lot number 030201 or later.

Note: SPMA via a PLC is not supported when a CP-series PLC is connected. (SPMA via an NS-series PT is supported with a CP-series PLC.)

Ladder Monitor

Easy Support Tools

Standard Feature

The ladder program can be monitored onsite without a laptop!

Ladder programs with I/O comments can be monitored on the PT's screen and the ladder program can also be edited with the Programming Console function.

Note: The Ladder Monitor function is not supported by the 5.7-inch models.

Note: The ladder monitor function is not supported for connection with a CP1E PLC.

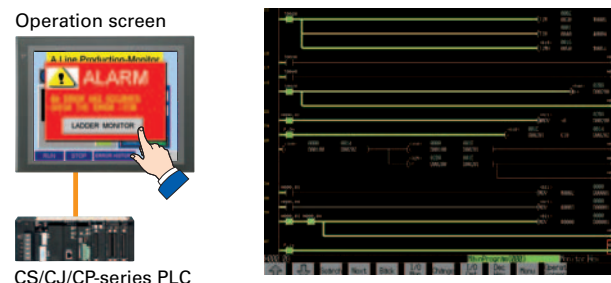

Also meets the requirements of users who need to display devices onsite, instead of the ladder program.

Easy Support Tools

Standard Feature

[Switch Box Function]

The operator can check the PLC status by displaying just the I/O comments and status.

[Device Monitor Function]

Displays the device's contents, allowing settings to be input and checked and making startup operations more efficient.

Note: The machine monitor function, and switch box function are not supported when a CP1E PLC is connected.

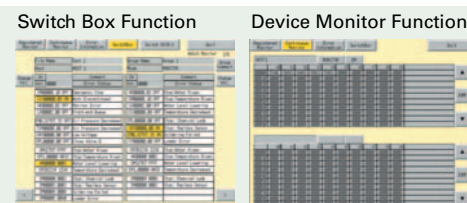

PLC Data Trace

Easy Support Tools

Standard Feature

The PLC's operation can be checked!

The PLC Data Trace function is built into the PT in addition to the Ladder Monitor and Device Monitor. A bit's status and operation can be viewed in a time chart just by setting the desired PLC bit's address in the PT. It is also now possible to display word data, save data in CSV files, and save time chart screens in BMP files.

Note: There are differences between this Data Trace function and the CX-Programmer's Data Trace function. Refer to the NS-series Programmable Terminal Programming Manual (Cat. No. V073) for details.

Note: The PLC data trace function cannot be used with the 5.7-inch model.

Note: The PLC data trace function is not supported for connection with a CP1E PLC.

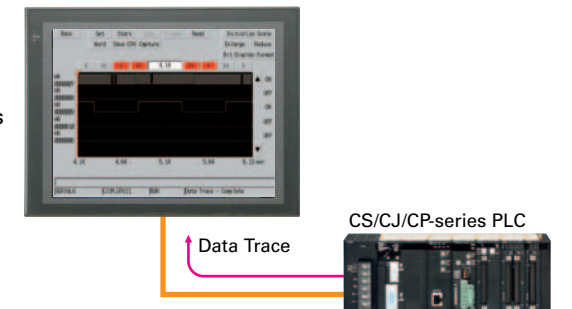

PLC Troubleshooter

Easy Support Tools

Constantly monitors PLC errors.

Automatically detects PLC errors and displays the error details and recovery procedure on the screen. Even if a problem occurs, it can be resolved quickly without referring to the manuals.

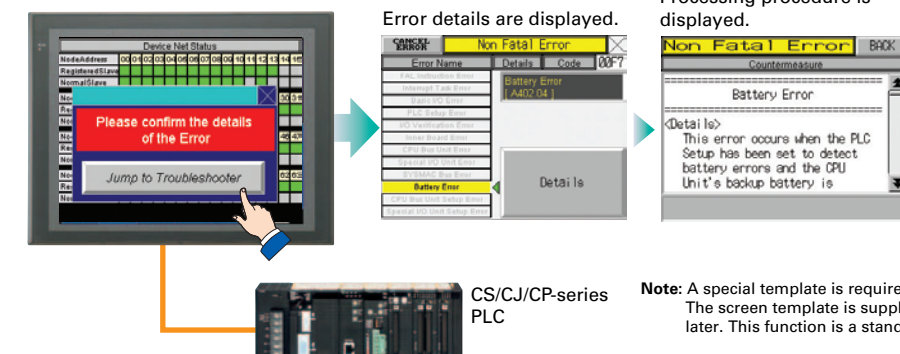

Note: A special template is required when using this function. The screen template is supplied with CX-Designer of version 2.1 or later. This function is a standard feature in the NSJ-series PTs.

Direct Connection to Temperature Controllers

Easy Access

Standard Feature

Connect OMRON Temperature Controllers directly to the NS-series PT.

OMRON Temperature Controllers can be connected directly to the NS-series PT's RS-232C port. Data does not pass through the PLC, so ladder programming is not required. Also, there are plenty of objects in the SAP Library for Temperature Controllers, and Temperature Controller screens can be created easily just by pasting objects from the SAP Library to the screens.

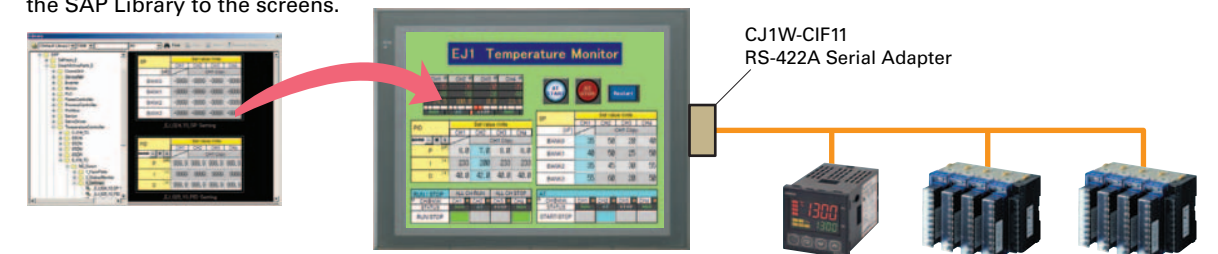

Note: An RS-422A Serial Adapter is needed to connect directly to a Temperature Controller. Refer to page 53 for a list of the Temperature Controllers that can be connected. A Conversion Unit is not required to connect to the RS-422A/485 serial interface of the NS15.

User-friendly Screen Creation

So easy to use, anyone can master it.

Without screen creation and ladder programming, the CX-Designer Screen Design Software is so easy-to-use that anyone can master it. Quickly create the required screen by dragging and dropping objects. OMRON's unified development environment lets you drastically reduce the work required to create screens.

All addresses and comments can be managed using a single Symbol Table.

Shows a list of addresses, names, and comments used in project screen data. Addresses, names, and I/O comments for the CX-Programmer can also be imported.

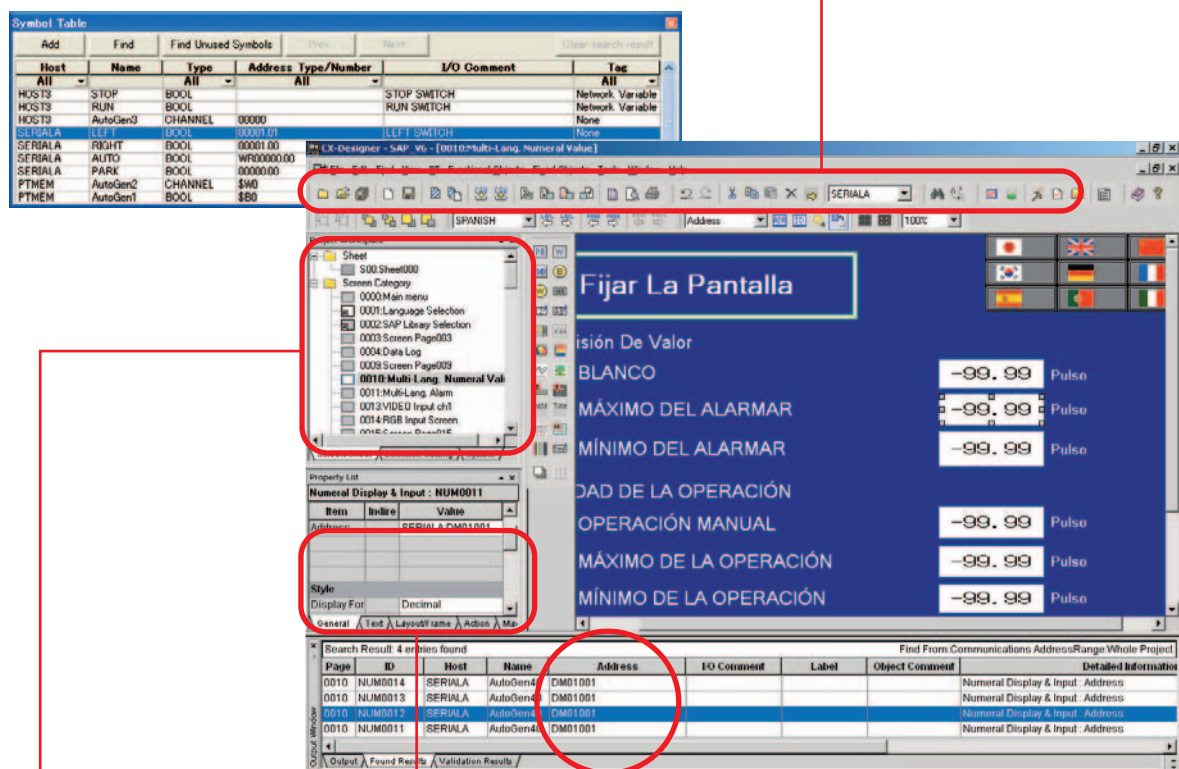

The project Workspace enables the user to look through the entire project.

- Screens you want to edit can be opened right away.
- Perform screen management, such as copying or deleting screens, by simply right-clicking.
- Reusing screens from other projects is easy with the CX-Designer.
- Settings for alarms, data logs, communications, and other functions can be easily accessed.

Drastically reduce the number of clicks in the project.

Just click on the object once to display or change properties. Multiple objects can be selected to display and change shared properties all at once.

The Output Window shows search results.

In addition to addresses and I/O comments used in screen data, labels can also be used as search strings and the results can be displayed.

Note: The same type of Project Workspace and Output Window as in the CX-Programmer are provided for the user interface.

Reading the Symbol Table

Dramatically reduces the need to manually input data such as addresses and I/O comments.

The symbol table created in the CX-Programmer during ladder programming can be read into the CX-Designer by dragging and dropping, so it isn't necessary to manually input data such as input addresses and I/O comments. Tags (i.e., network symbols) can also be read into the CX-Designer.

Note: Version 8.0 or higher of the CX-Programmer support tags (i.e., network symbols).

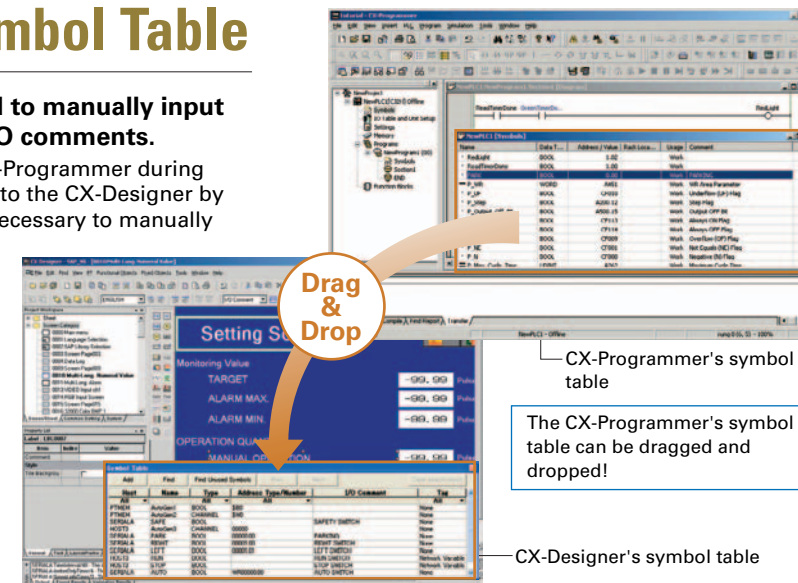

● Example of Reading the Symbol Table

The symbol table read from the CX-Programmer can be directly dragged and dropped to the touch switch and lamp.

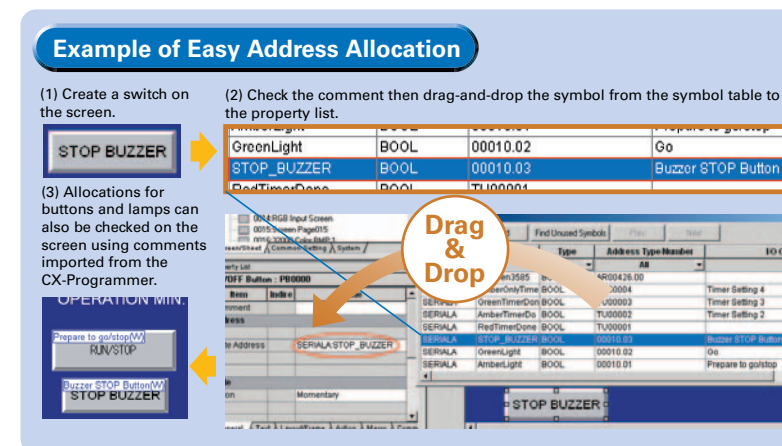

● Example of Reading I/O Comments

If Use I/O comment is selected in advance for the Use symbol text as label, the I/O comments are automatically used as labels when addresses are dragged and dropped from the symbol table. (If Use symbol names is selected, the symbol names are used as the labels.)

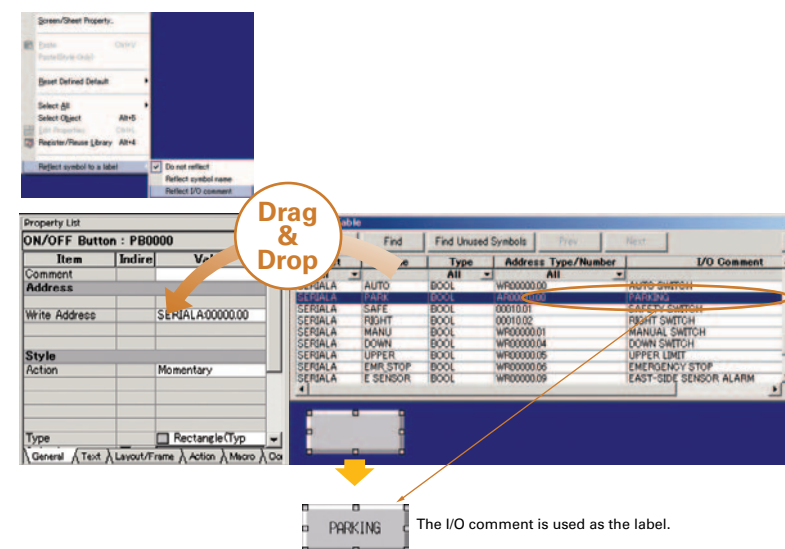

Reading Another Project's Screens and Objects

Easily reuse screen resources by dragging and dropping them.

Resources from another project can be easily reused by just selecting the screen or objects that you want to read and dragging and dropping it, so screens can be created intuitively.

[Example screen 1]

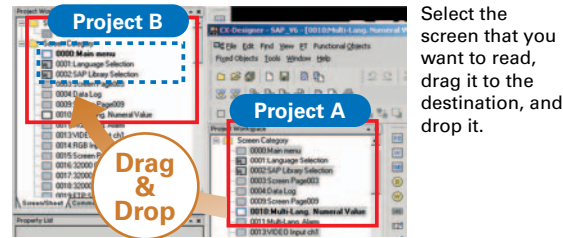

Select the screen that you want to read, drag it to the destination, and drop it.

[Example screen 2]

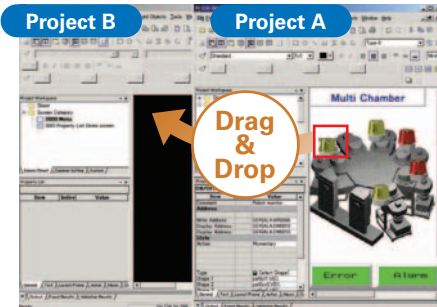

Select the part that you want to read, drag it to the destination, and drop it.

Reading CAD Files

It is possible to import DXF files by dragging and dropping them. The files are read as a diagram, and so less capacity is used than with images. It is also easy to customize the diagram by changing the shape or color.

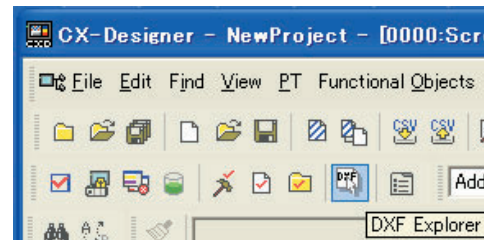

Integrated Simulation with the PLC Ladder Program

The screen data and ladder program can be checked simultaneously in the computer.

The CX-Designer and CX-Programmer interconnects the test functions in the computer through the CX-Simulator. The screens and ladder program checks are performed simultaneously, which significantly increases debugging efficiency. The CX-Programmer also has a new button for integrated simulation. And, work efficiency is further improved with the ability to keep required work screens pinned on front and to zoom in or out as desired.

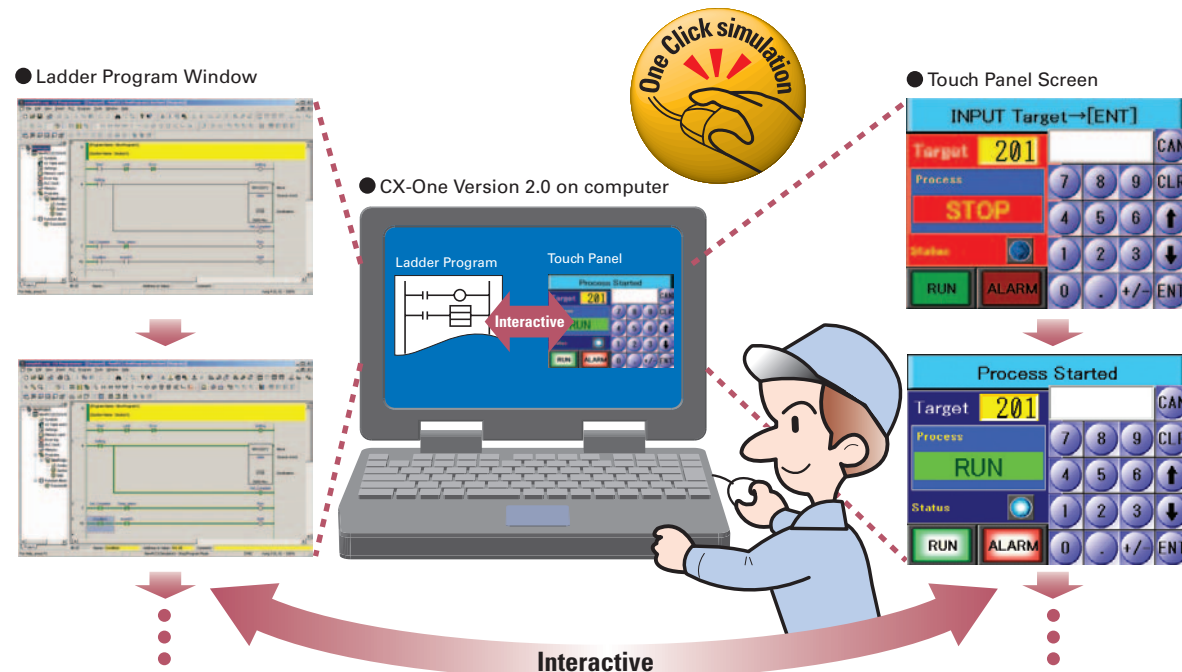

Editing of Multiple Objects

Objects can be edited very efficiently in a list!

Addresses and other settings, such as labels and colors, can be set together in a list, making editing operations much more efficient.

The attributes of multiple parts can be edited together, too.

When the common attributes (such as background color and text color) of multiple parts are being changed, the attributes can be changed together using the property list.

[Example screen 1] After editing the settings in the list, press the OK Button to make the new settings effective immediately.

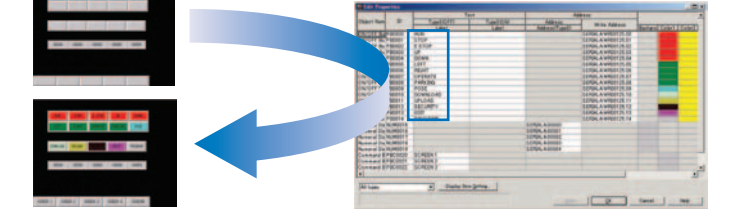

[Example screen 2] If the background color is changed from white to gray in the property list, the background color is changed for all of the selected objects.

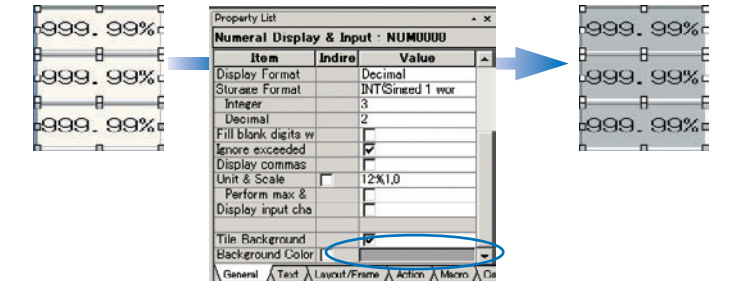

Editing of Overlapping Objects

The Select Object command and filter function are the solution for overlapping objects!

The Select Object command is a powerful tool when you want to edit object hidden by overlapping. A filter function can also be used to aid editing by displaying only the objects to be edited.

[Object Selection Window]

Right-click and select Select Part to display the objects (all types) on the screen.



All types	Object Comment	ID	X	Y
<input type="checkbox"/>	P10000	96	136	
<input type="checkbox"/>	P10001	200	136	
<input type="checkbox"/>	P10002	304	136	
<input type="checkbox"/>	P10003	408	136	
<input type="checkbox"/>	P10004	56	104	
<input type="checkbox"/>	P10005	200	104	
<input type="checkbox"/>	P10006	304	104	
<input type="checkbox"/>	P10007	408	104	
<input type="checkbox"/>	P10008	96	232	
<input type="checkbox"/>	P10009	200	232	
<input type="checkbox"/>	P10010	304	232	
<input type="checkbox"/>	P10011	408	232	
<input type="checkbox"/>	P10012	96	260	
<input type="checkbox"/>	P10013	200	260	
<input type="checkbox"/>	P10014	304	260	
<input type="checkbox"/>	P10015	408	260	
<input type="checkbox"/>	LEL0016	72	168	
<input type="checkbox"/>	LEL0017	96	80	

[Filter Function]

Use the Select Part command's filter function to select the objects (ON/OFF Button) that you want to edit.



Only the edited object is displayed and it can be edited easily.

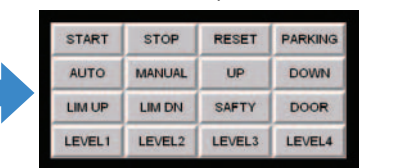

Programming with Symbols

Screens can be created even when addresses are unknown.

Screens can be created even if the addresses have not been determined. Addresses can be input as either names or actual addresses and the addresses can be input from the symbol table after the addresses are determined.

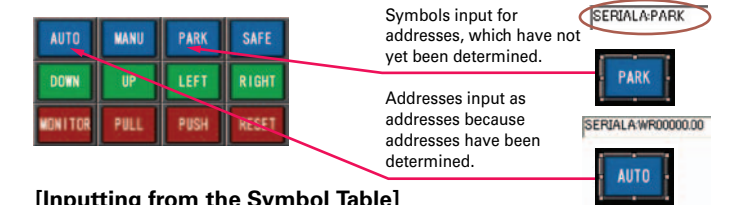

[Inputting from the Symbol Table]

Addr	Name	Type	Address	Type/Number	I/O Comment	Type
All	All	All	All	All	All	All
PTMEM	AutoGen1	BOOL	800			None
PTMEM	AutoGen2	CHANNEL	840			None
SERIALA	PARK	BOOL			PARKING	None
SERIALA	SAFE	BOOL			SAFTY SWITCH	None
HOSTD	AutoGen3	CHANNEL	10000			None
SERIALA	RIGHT	BOOL	10000 01		RIGHT SWITCH	None
SERIALA	LEFT	BOOL	10001 01		LEFT SWITCH	None
HOSTD	RUN	BOOL			RUN SWITCH	Network Variable
HOSTD	STOP	BOOL			STOP SWITCH	Network Variable
SERIALA	AUTO	BOOL	WP00000000		AUTO SWITCH	None

Addresses are input in the symbol table after the addresses are determined.

Plenty of Basic Functions

Multi-language Support

There are 42 languages* supported and useful label switch functions are also built into the PT. Unicode is supported and 42 Asian and European languages can be combined in screens. Also, it is possible to switch between up to 16 labels using the label switching function, so it is possible to support up to 16 languages in a single screen just by specifying the language to be displayed in each label. (*Refer to page 44 for details.)

NS Series

[The labels' text attributes can also be reflected when importing.]

When screen data is imported, text attributes can be applied to the specified labels and attributes such as the font and text color can be reflected to other languages labels.

Multi-language CSV data

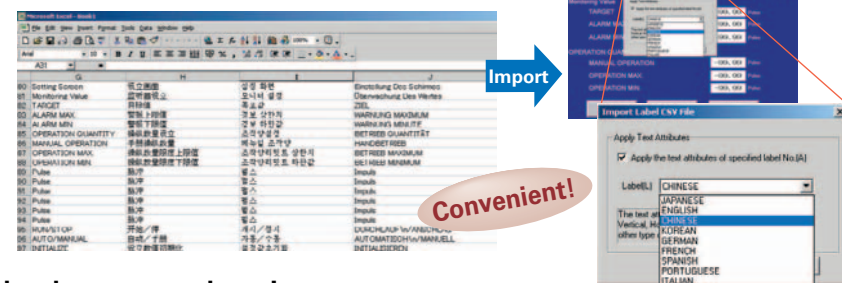

Convenient!



ราชอาณาจักรไทย
Thai Displays Also Supported

Multi-language conversion has become much easier.

The screen data in the source language is exported to a CSV file and sent to a translation agency by e-mail for translation. Later, the translated CSV file is just imported to easily provide multi-language support.

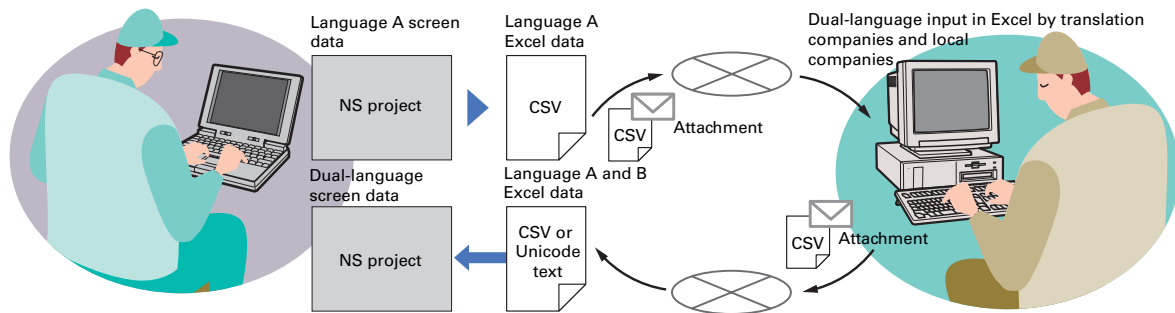

Note: Windows 2000 or XP is required for multi-language support.

Multi-language System Messages

First in the Industry* Eight Languages Supported as Standard Features

The system program of NS-series PTs supports Chinese and European languages. All eight languages are a standard feature, including Chinese (traditional and simplified), Spanish, Italian, German, and French, in addition to the previous Japanese and English. Along with maintenance menus, messages for communications errors, communications settings, and screen transfers can be displayed in any of eight languages. Maintenance can be performed in the desired language. The language can be easily set using the NS-series PT or screen data.

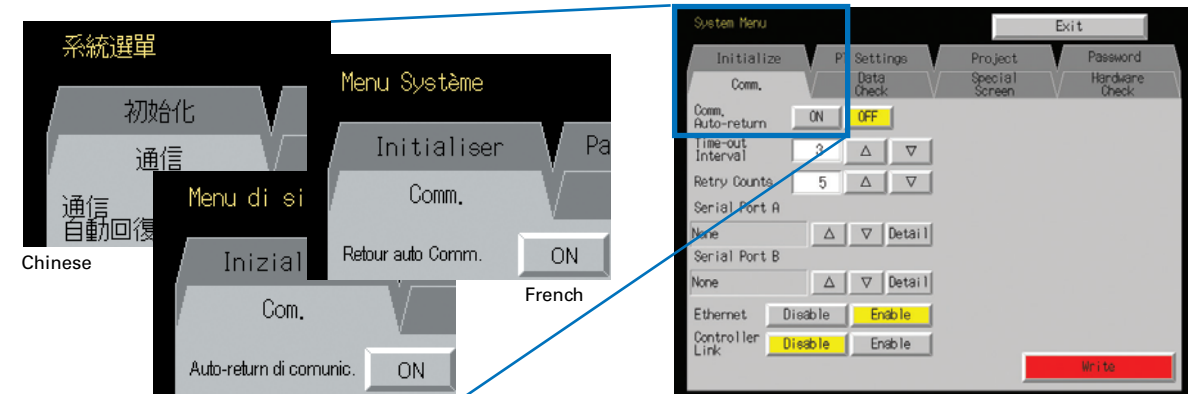

Chinese, Italian, French, English system menu (maintenance menu)

*: OMRON research as of July 2007.

Greater Beauty

Make numeral displays and input objects more attractive, and increase or decrease the character string font size as desired.

Use an attractive font for numerals that looks good on the display even when it is enlarged. Seven-segment fonts are also available. And, smooth fonts are used for alarms and character strings, and scalable fonts can be selected. In addition, worldwide support is provided with 42 languages, including Thai. (Refer to page 44 for details.)

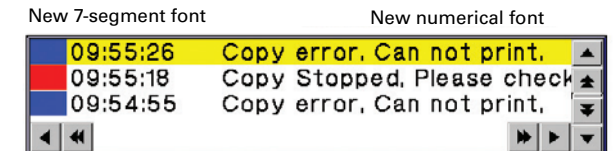

Scalable gothic font enables smooth display with the font scaled to the required size.

Greatly Enhanced Libraries for Beautiful Lamps and Switches

A selection of over 1,000 beautiful objects is provided. Also, it's easier to allocate and change objects.

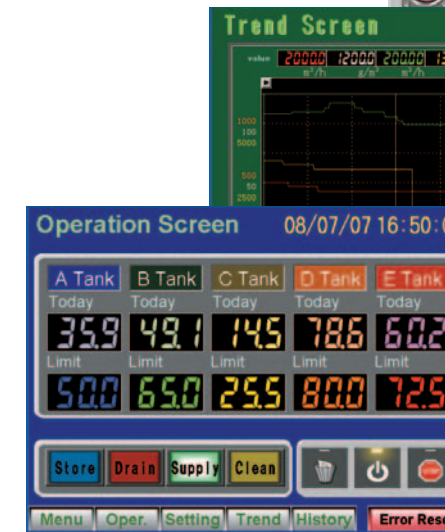

Huge 60-MB Image Memory

Real images can be used liberally, without worrying about memory capacity!

The industry's highest standard image memory: 60 MB. Take full advantage of the 32,768-color palette and spacious memory to design realistic images.



When an error occurs, the location of the error can be shown realistically in a picture.

Easier Design of Machine Error Screens

You can easily make a machine troubleshooter without making similar error screens.

Individual error screens that were previously made for each error can now be integrated into one. It is possible to switch only the error details (text and screen) without ladder programming in conjunction with the alarm bit.

With this system, this frame is shared, and the error details in the pink frames are switched with an alarm or other item as the trigger.

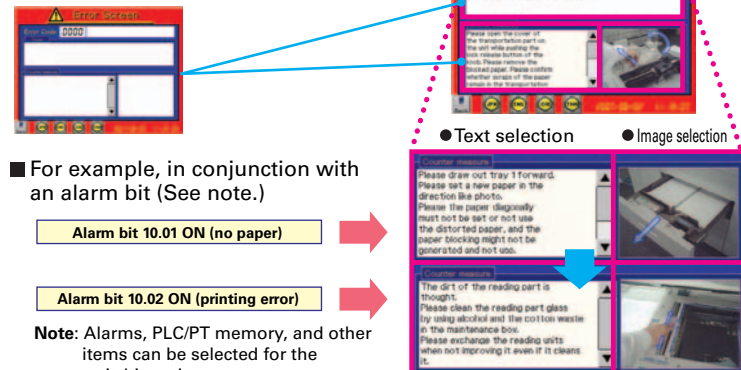

Easy-to-Use Multifunction Objects

Multiple functions can be executed on-screen with one button without macros.

Multifunction Objects combine the functions of multiple objects into one object. Multiple functions can be executed by pressing one button without using troublesome macros. Setup is easy. For example, a setting can be made on-screen using the Support Software to turn ON a bit to start a machine, set a value, and then change the screen.

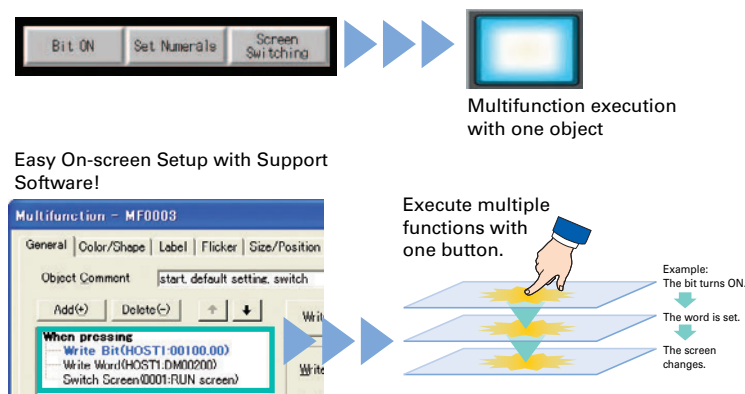

Multifunction Objects support four safety functions.

Switches that do not immediately operate when touched can be easily made without ladder programming.

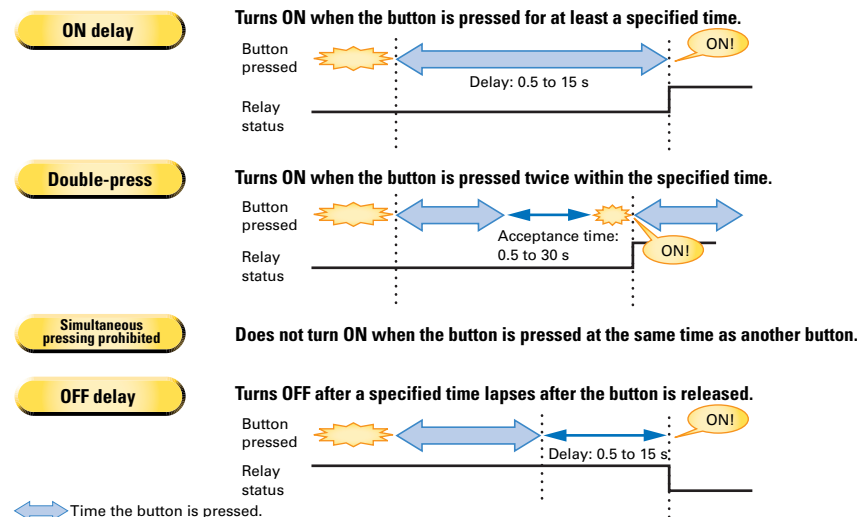

Plentiful Graphing Functions

A device's operation is easier to understand when presented visually.

A variety of graphing functions are built into the PTs, such as the trend graph, which can log data over a long term, and the line graph, which can display overlapping graphs. A device's operation is easier to understand when presented visually.

Long-term data logging and storage are also easily achieved.

[Trend Graph (Data Log) Function]

Logging data is stored as a CSV file in the Memory Card mounted in the NS-series PT. The data stored in the Memory Card can be read or deleted from the screen.

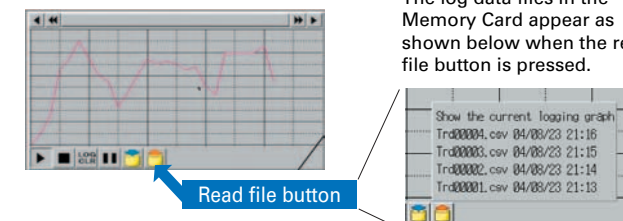

A log can be saved automatically, without any programming, just by selecting the Save the data periodically Option in the Data Log Setting Window.

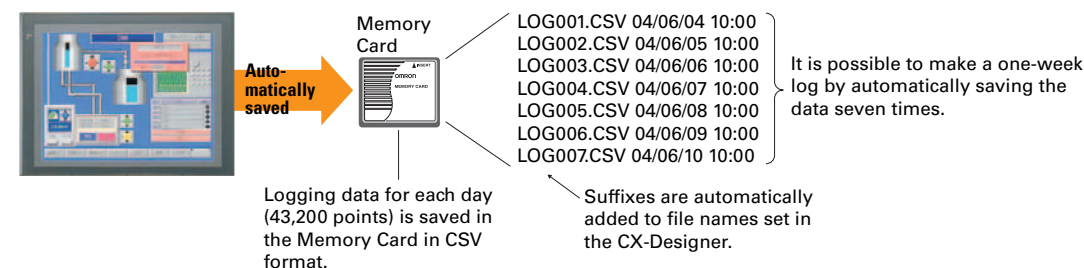

The earlier line graph function has been further improved.

[Line Graph Function]

The data logged by the PLC can be displayed in overlapping graphs, so a device's operation can be compared for evaluation and analysis. In addition, up to 1,000 words of consecutive data can be displayed as a line graph, data can be displayed together, and any region can be magnified.

(1) Graphs can be superimposed.

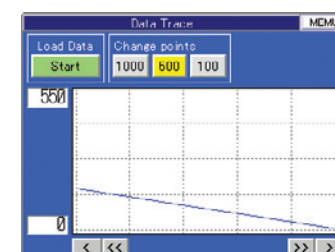

(2) The display can be magnified.

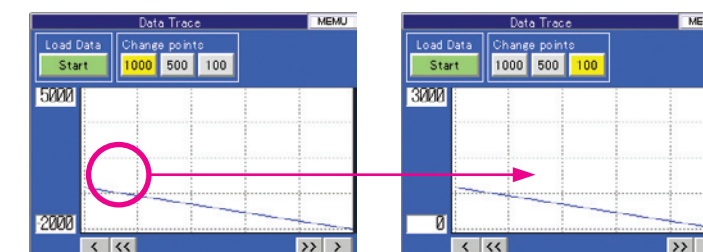

Any position from the host (PLC) can be plotted as a graph.

[Continuous Line Function]

A graph can be plotted in any position by specifying the X and Y coordinates of the vertices. Also, the graph can be moved on the screen by specifying the movements from the PLC.

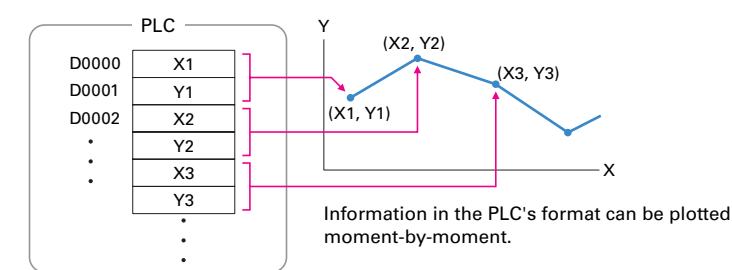

Screen Data Security Functions

Protect important screen data with a password.

If password protection is set in the data transfer security settings when the screen data is designed, a password must be entered to download or upload the screen data, so important screen data can be protected.

A password between 4 and 64 characters long can be set. The download/upload will start if the user inputs the password that was set when the screen was designed. (Password input will be disabled if the wrong password is input 3 times in a row.)

If a password has been set, the password is required to transfer screen data (download or upload) with the Memory Card.

Security password

User Security Functions

Operator access rights and the operating format can be set to one of five password levels.

Each operator can be given one of 5 password levels using the User Security (level authentication) function. A password level can be set for each object, so various objects can be made inoperable or hidden based on the operator's access level.

Level 5	Line Operator
Level 4	Group Leader
Level 3	Line Manager
Level 2	Maintenance
Level 1	Administrator

Operator passwords are managed in 5 levels. Passwords can be up to 16 characters long and the access rights increase as the level number increases.

The operator cannot manipulate objects with a password level (authentication level) higher than the operator's login level.

FTP Function

You can partially replace text and pictures from your computer.

FTP (File Transfer Protocol) has been added! Texts, lists, and recipes can be replaced with the put/get command from your computer! You can even replace BMP files from your computer easily.

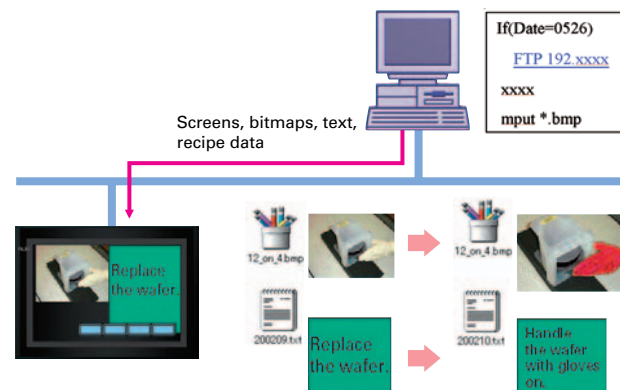

MEMO.

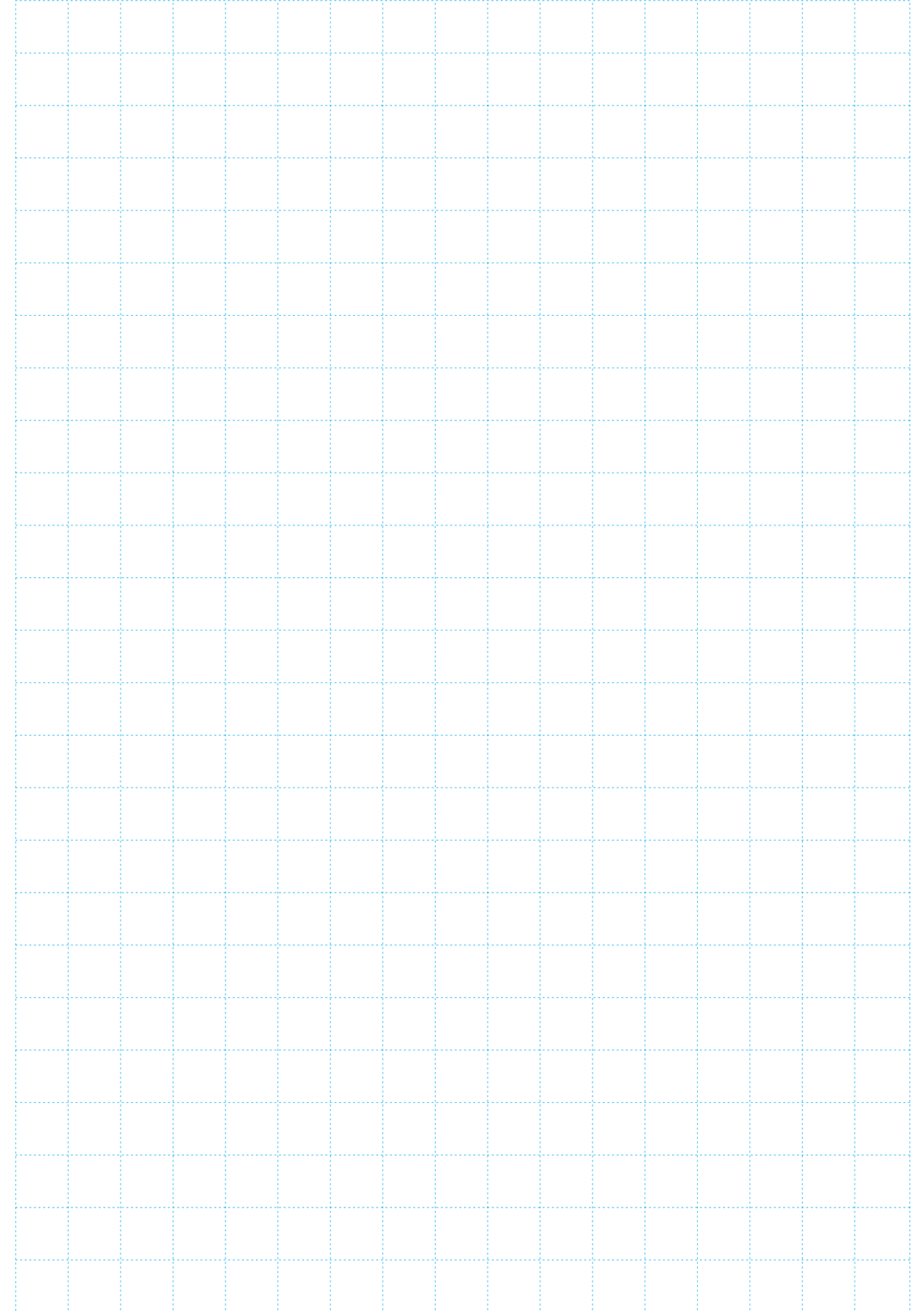

Connect! Expand! Feel the NS Series, the power of networking.

Provides serial NT Link communications supporting both 1:1 and 1:N connections. The NT Link has more efficient communications than Host Link and its capabilities are especially apparent in applications with multiple PTs connect to the PLC. The NS-series PTs can also support communications with multiple PLCs and multiple NS-series PTs through Controller Link and Ethernet connections, so the network can be configured freely to match the requirements and scale of the application. In addition, using the NS-Runtime makes it possible to monitor machine status and log data from the host.

[Example NS-series Network Configuration]

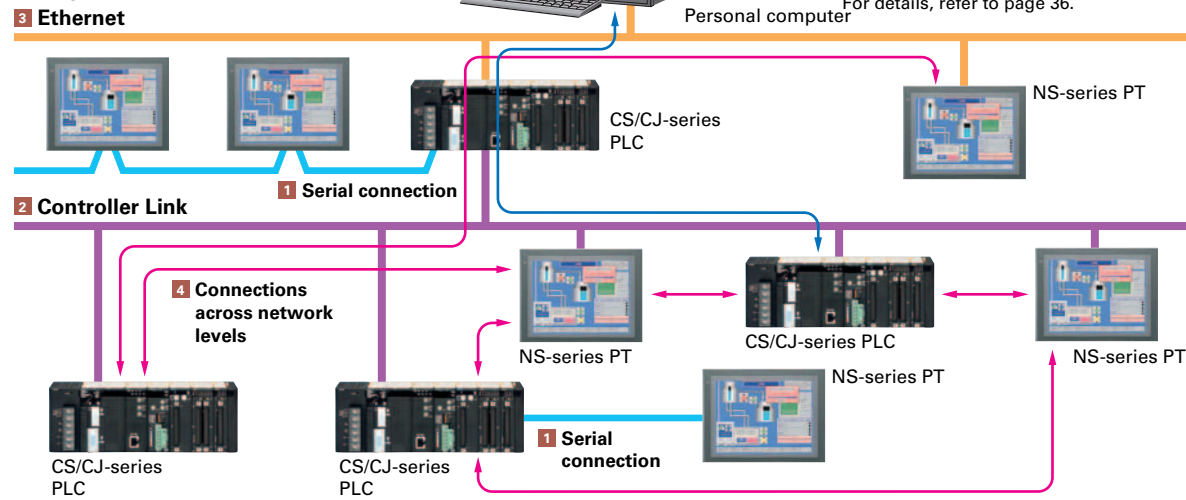

1 Serial connection

1:1 NT Link or Host Link

- NS:PLC = 1:1
Connecting with the PLC through port A or port B



- NS:PLC = 1:2

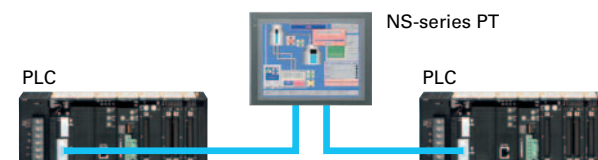

1:N NT Link

- NS:PLC ratio = 8:1 max. Up to 8 NS-series PTs can be connected to each of the PLC's RS-232C/RS-422A ports.

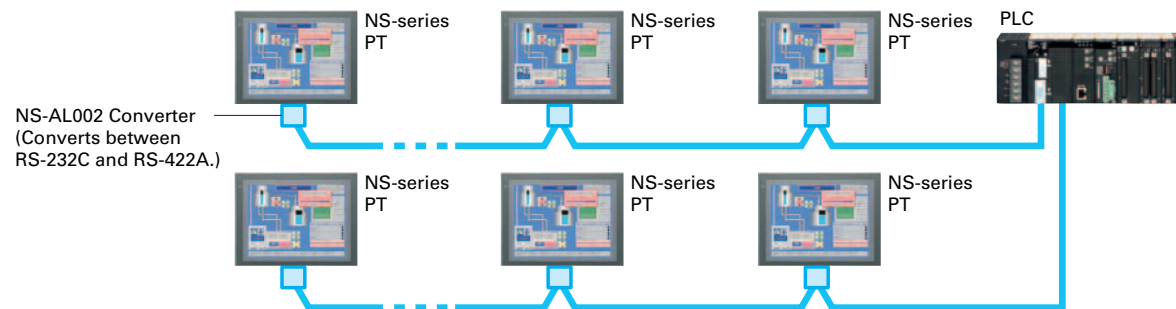

2 Controller Link Connection

The PT can be connected to an OMRON Controller Link network by mounting a Controller Link Interface Unit.

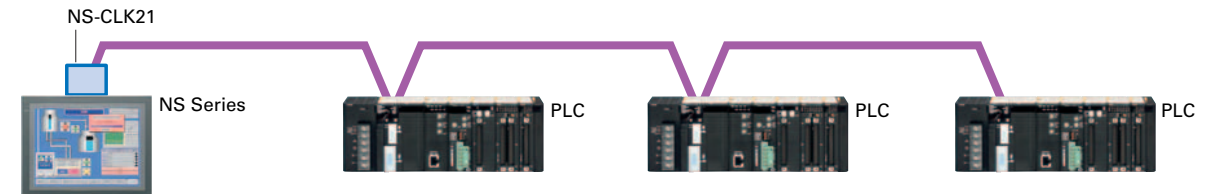

If a Controller Link connection is used, data links can be set between PLCs and multiple PLCs can be monitored/set from the NS-series PT's screen.

- Baud rate
2 Mbps (500 m max.)
1 Mbps (800 m max.)
500 kbps (1 km max.)
- Max. number of nodes: 32 nodes

3 Ethernet Connection

If an Ethernet-compatible NS-series PT is used, the PT can connect to a PLC with an Ethernet Unit and an Option Unit is not needed to connect at the PT.

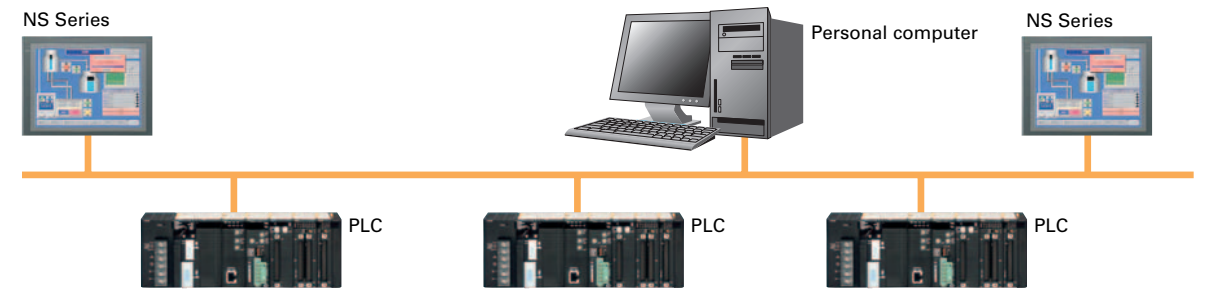

4 Connections Over Network Levels

The NS-series PTs can connect to a variety of devices in the network, through as many as 3 network levels. For example, if SAP (Smart Active Parts) are being used, an NS-series PT connected by Ethernet can be used to monitor the information in a PLC connected through Controller Link as well as the information in the DeviceNet Slaves connected to that PLC.

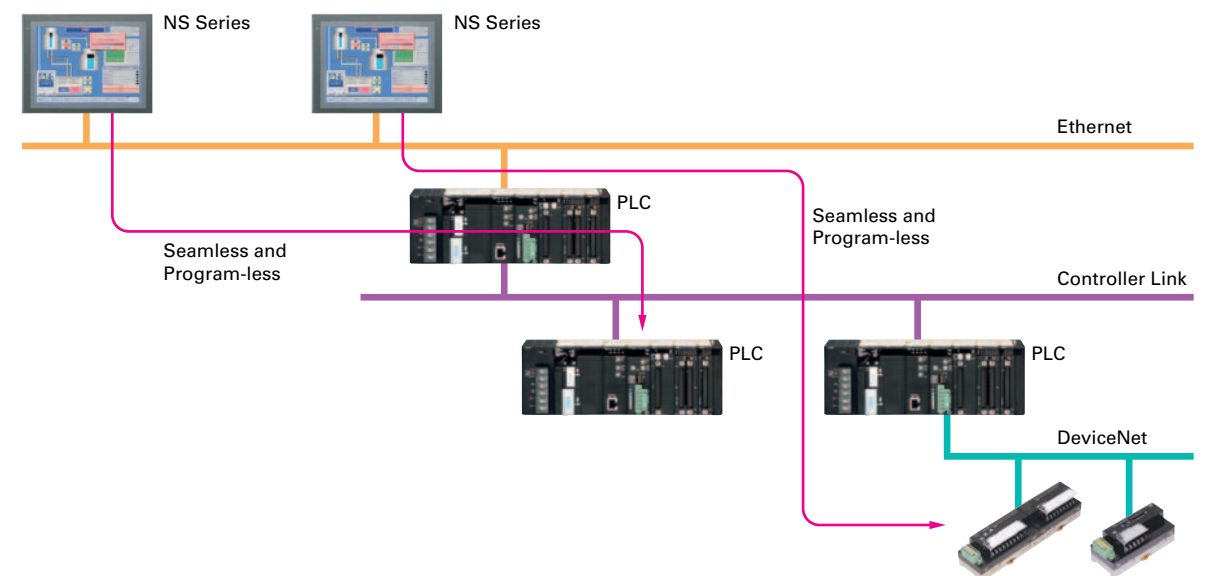

NS-Runtime

Achieve machine/line monitoring and data logging on your office computer.

Note: To convert screens from an NS-series PT, the system version must be 8.1 or lower. Screens with system version 8.2 cannot be converted to NS-Runtime.

Machine Viewer

Machine monitoring in an office environment.

There is no need to create complex host applications. Moreover, when an alarm occurs, a PDF file can be displayed as maintenance information. NS Series screens can be reused on the computer, and screens can be also newly created independently of touch panels at the production site.

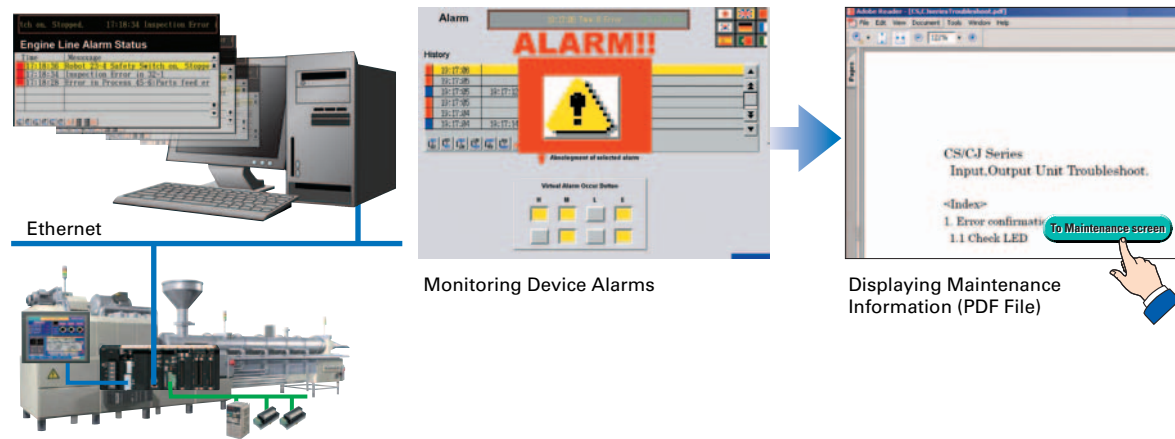

Wide Screen

Computer output can be displayed on another wide-screen monitor.

XGA (1,024 x 768 dots) and up to a maximum screen size of 3,840 x 2,400 is supported. Alarms occurring in devices or the line can be monitored.

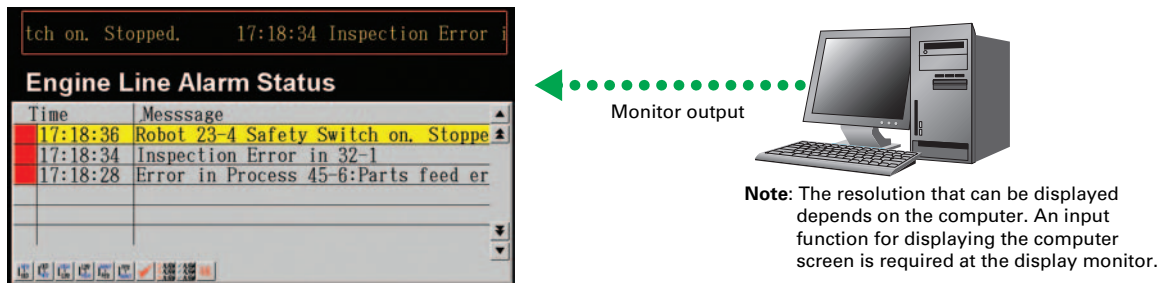

Data Logger

Log large amounts of data using a personal computer.

Data can be logged through background processing, with up to 160,000 points stored in one file. The logged data is stored in CSV format, and data can be displayed on data log graphs.

Example: 160,000 Points
Data can be logged for approximately 7.4 days, assuming data is logged every two seconds for 12 hours a day. By using automatic file saving, data logging can be continued even longer than 7.4 days.

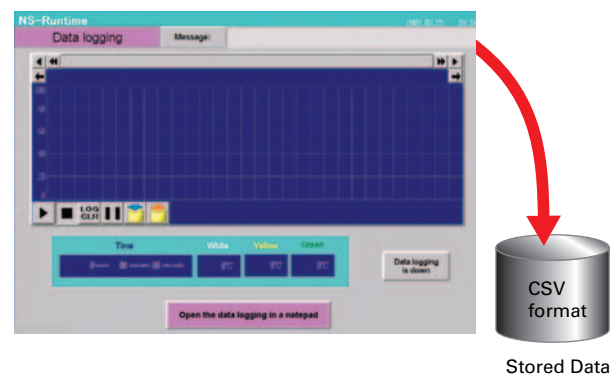

Recipe Handling

Checking machine data or switching processes from a host computer is easy.

Parameter groups in the PLC can be transferred together to a computer, and the transferred data can be checked and edited in CSV format, e.g., using Excel. The edited data can then be transferred together back to the PLC.

	A	B	C	D	E
1	001	C/JIG	666	666	666
2	002	CPM2A	55	18	100
3	003	D1JL	2	20	200
4	004	E5GN	3	30	300
5	005	F3SJ	4	40	400

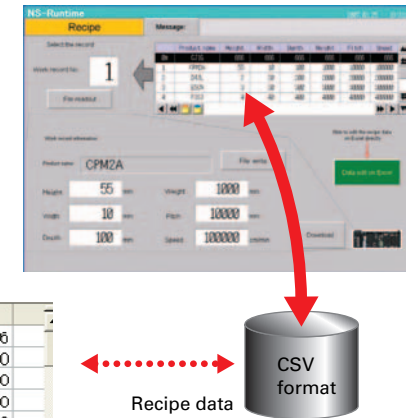

Easy Installation

After installing the NS-Runtime, just place the screen data in a specified folder and start, that's it.

To get started, just install the NS-Runtime in the computer and place the screen data in the applicable folder. NS/NSJ-series screens and NS-Runtime screens can all be managed using one single tool.

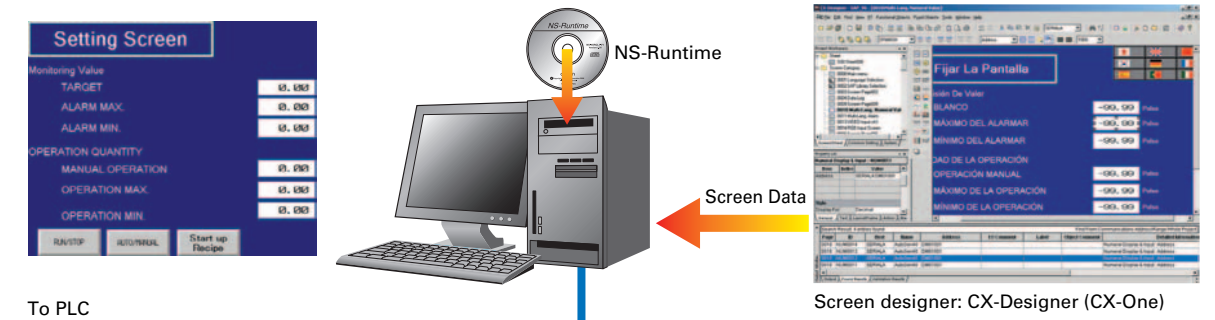

Note: The NS-Runtime will operate in a computer environment even if the CX-Designer installed is not installed. The hardware key (USB dongle) that is supplied with the NS-Runtime is required for operation.

Application Startup Function

User applications can be started from NS-Runtime.

Applications can be started simply by pressing buttons on the screen.

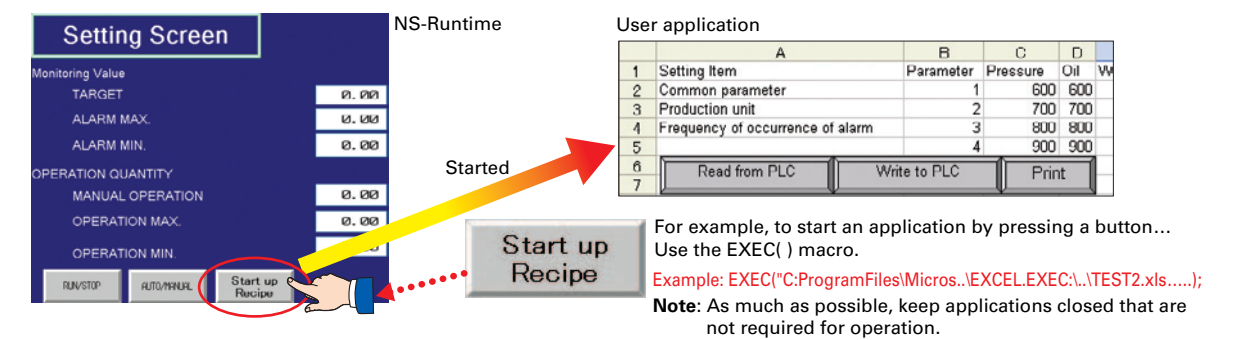

- Do not use this product for 24-hour operation in an FA environment.
- OMRON shall not be responsible if the computer or application does not operate properly due to problems such as noise.
- OMRON shall not be responsible for any problems that may be caused by any applications other than OMRON products.

What's New

Compatibility

Screen Design Software

Basic Functions

NS-Runtime

Specifications

System Configuration

System Configuration Diagram

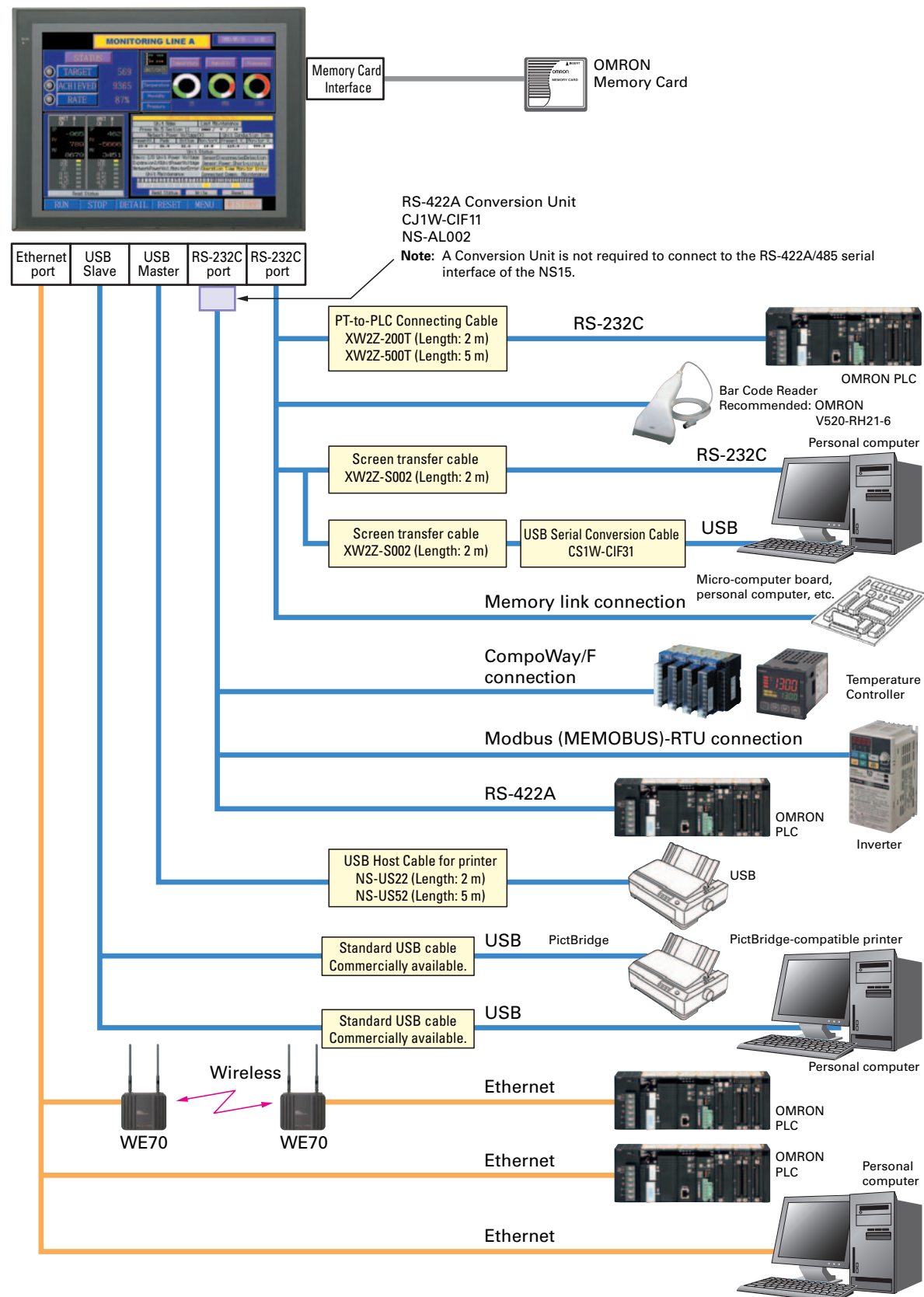

System Configuration Diagram (Expansion Bus Interface)

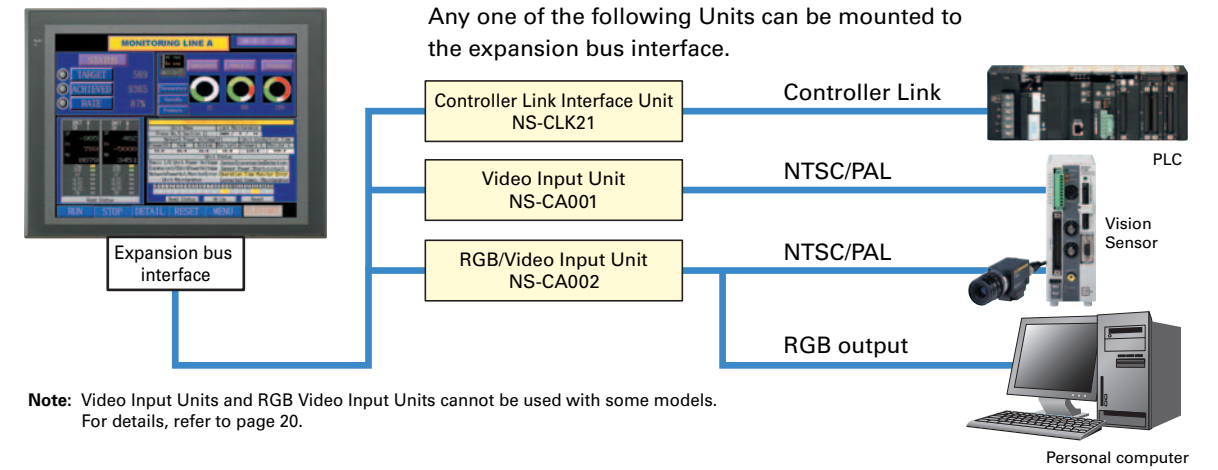

System Configuration Diagram (Multi-vendor)

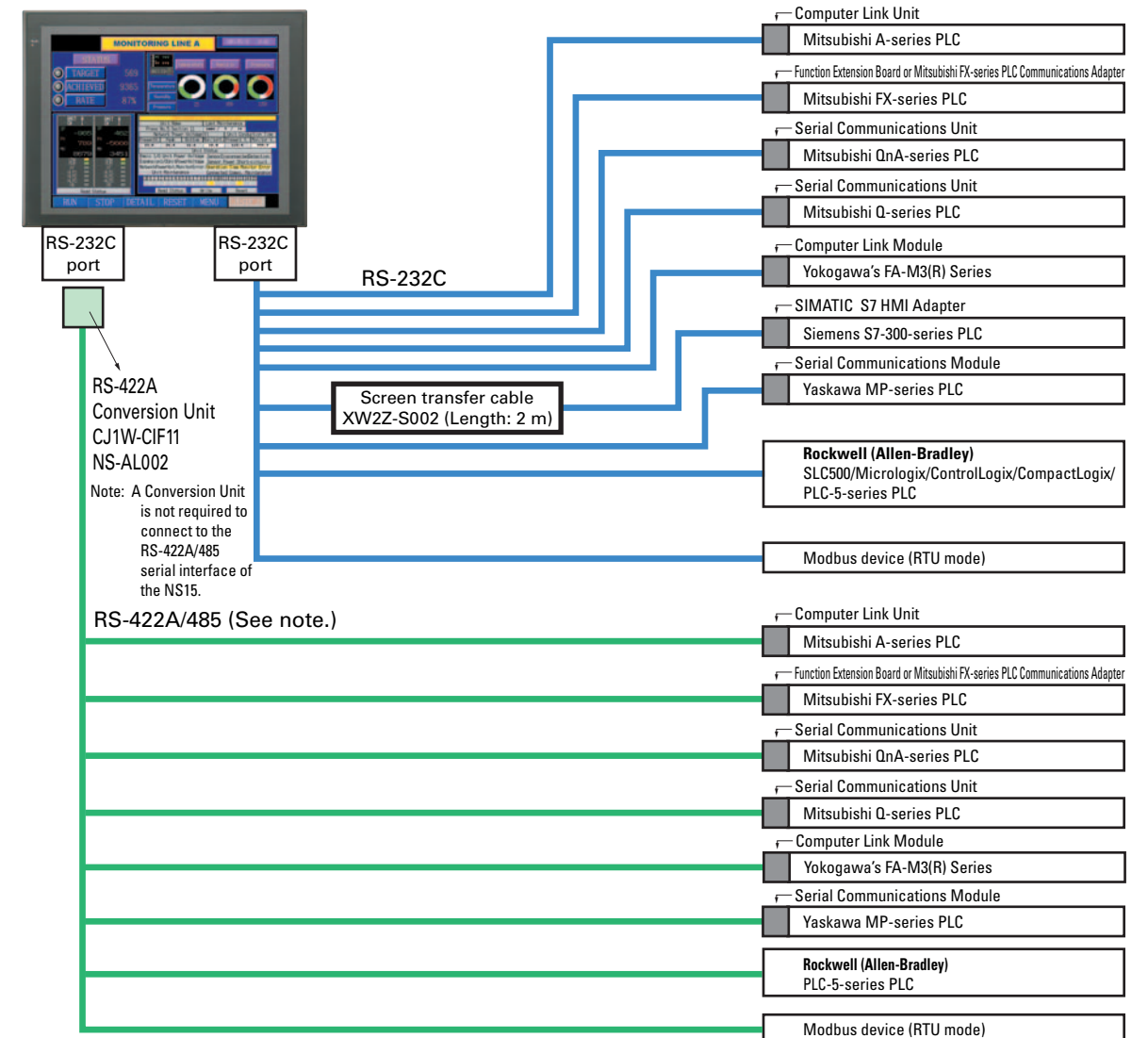

Note: Whether an RS-422A or RS-485 connection is supported depends on the device that you are connecting to. For details, refer to the list of connectable devices on page 52 and the NS-series Host Connection Manual: Multi-vendor (Cat. No. V085)

Component Names and Options

High-reliability and Advanced Functions in the Industry's Slimmest PT

Super-thin 48.5-mm Body for a Slimmer Control Panel

This thin-profile model has few protrusions so it can be incorporated easily into a panel or machine. The PT can help save space when space is at a premium.

■ NS12, NS10

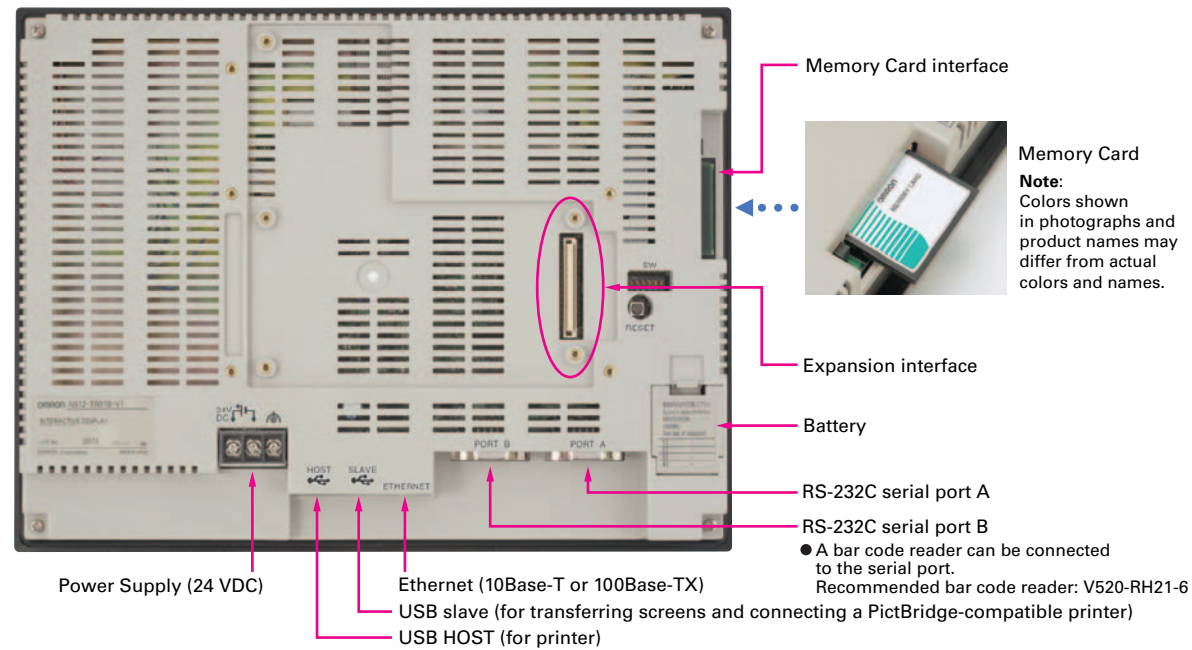

■ NS8

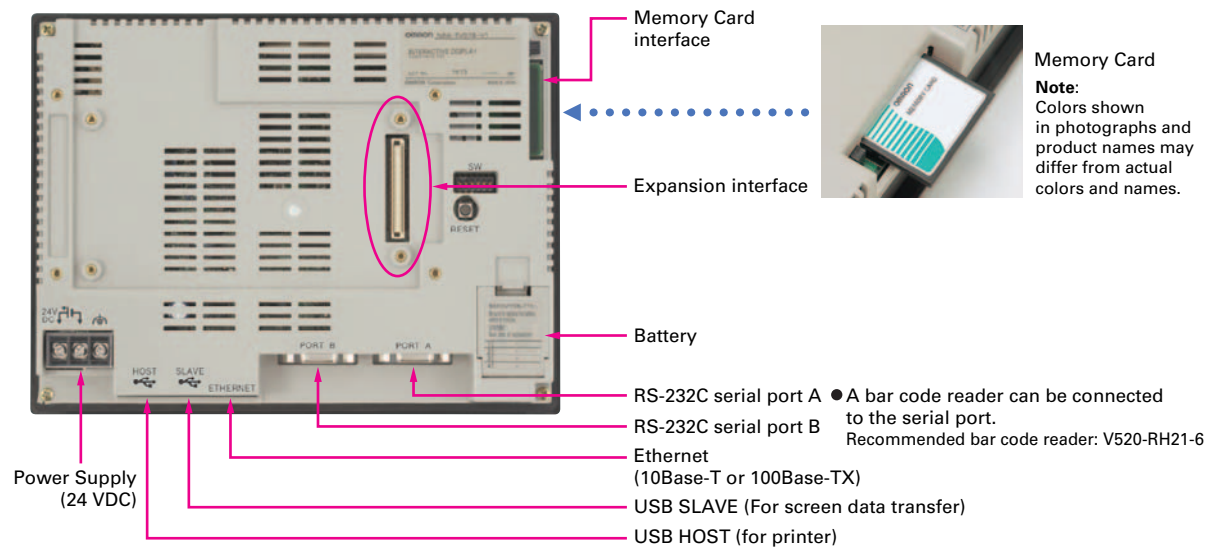

● Built-in Expansion Interface

The NS-series PTs have a built-in Expansion Interface for future expandability.

● USB Ports

A printer can be connected to the USB port. Refer to page 49 for recommended printers.

■ NS5

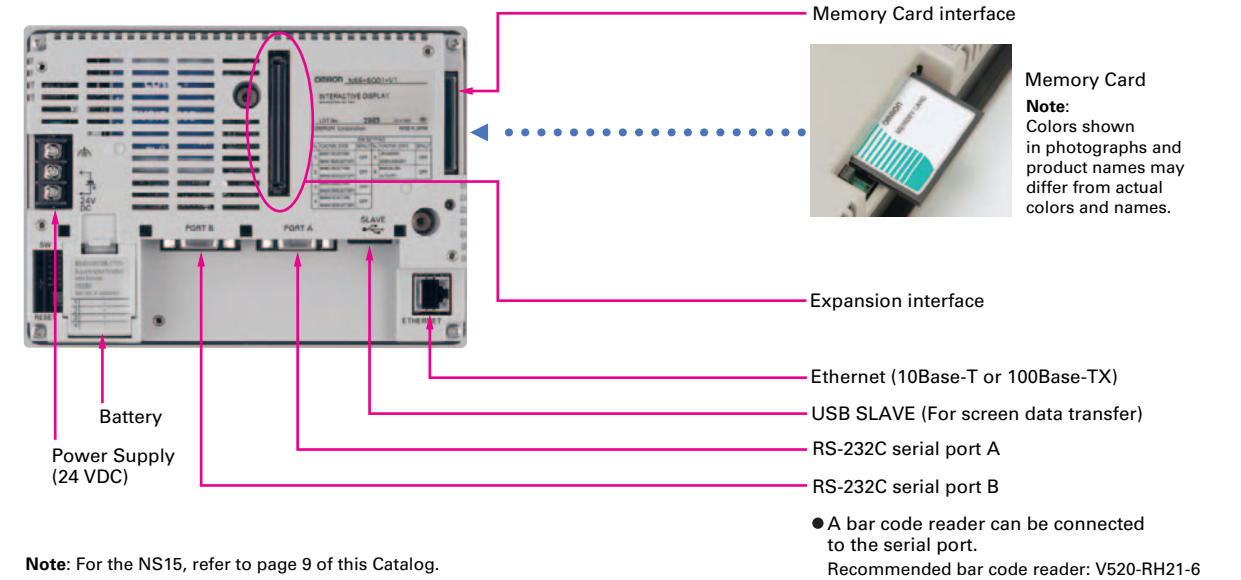

Note: For the NS15, refer to page 9 of this Catalog.

Optional Products

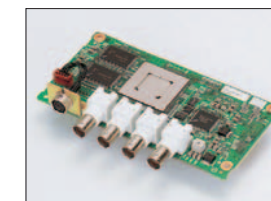

Video Input Unit
NS-CA001 (with Cover)

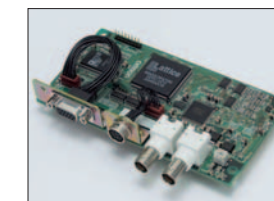

RGB/Video Input Unit
NS-CA002 (with Cover)

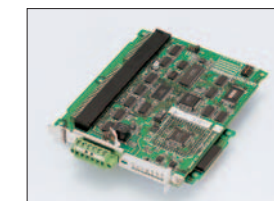

Controller Link Interface Unit
NS-CLK21 (with Cover)

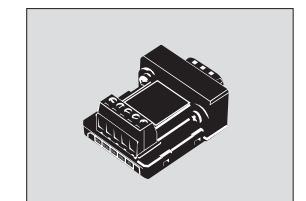

RS-422A Adapter
CJ1W-CIF11



RS-232C/RS-422A Conversion
Unit NS-AL002



Communications Cable
XW2Z-S002

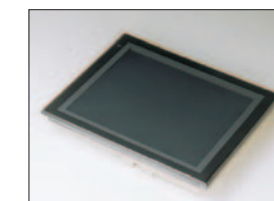

Protective Cover/Anti-reflection
Sheet for NS-series PT
NS-KBA0(N)
NT30/NT31C-KBA05(N)



USB Serial Conversion Cable
CS1W-CIF31

Note: Colors shown in photographs and product names may differ from actual colors and names.

NSH5 Series

A hand-held version of the NS5 is now available to perform operations at the production site. The NS-series PT's have a complete set of functions that can be used at the production site, such as the SAP Library, multi-language support, and Programming Console functions.

Function Switches
Use the ten functions switches.
F1, F2, F6, F7: Wired outputs
F3 to F5, F8 to F10: Communications outputs

Memory Card Interface and USB Slave Connector.
Easily transfer screens or save logs at high speed using a USB connection.

Emergency Stop Switch.
3PST-NC Structure
DPST-NC: Increase safety (wired outputs).
SPST-NC: Input to internal NSH5 memory, output to a lamp for emergency stop operation, or output via communications, e.g., to a PLC.

Water Resistance to IP65
The water-resistant structure is equivalent to IP65 on all surfaces.
Note: The PT may not be suitable for use in environments with long-term water exposure.

3-Position Enable Switch
Increased safety with DPST-NO structure (wired outputs).

PT and Cable Sold Separately
Select the Cable according to the application (RS-232C/RS-422A).
Connector-loose wires, UL connector, 3 m or 10 m.

Superior Shock Resistance
Consistent with JIS B 3502, IEC 61131-2 (drop shock).

●Precautions for Emergency Stop Switches

When using a hand-held NSH5 that will be installed and removed from a control panel or Removable Box, always use the specified Stop Switch (Gray/NSH5-SQG10B-V2) to conform to Safety Standards (EN 60204-1).

●Options

■ Removable Box

A separate external circuit is not required because the Removable Box has been configured so that the emergency stop switch line will not turn OFF (i.e., so that the emergency stop circuit will operate) even when the NSH5 is removed.



■ Visor

Use when the NSH5 is in direct sunlight. Installing a visor also helps protect the Emergency Stop Switch and prevents improper operation from occurring inadvertently when the PT is put down.



■ Mounting Bracket

Use to attach the NSH5 to a control panel.

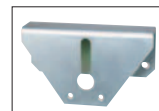

System Configuration Diagram (NSH5 Hand-held PT)

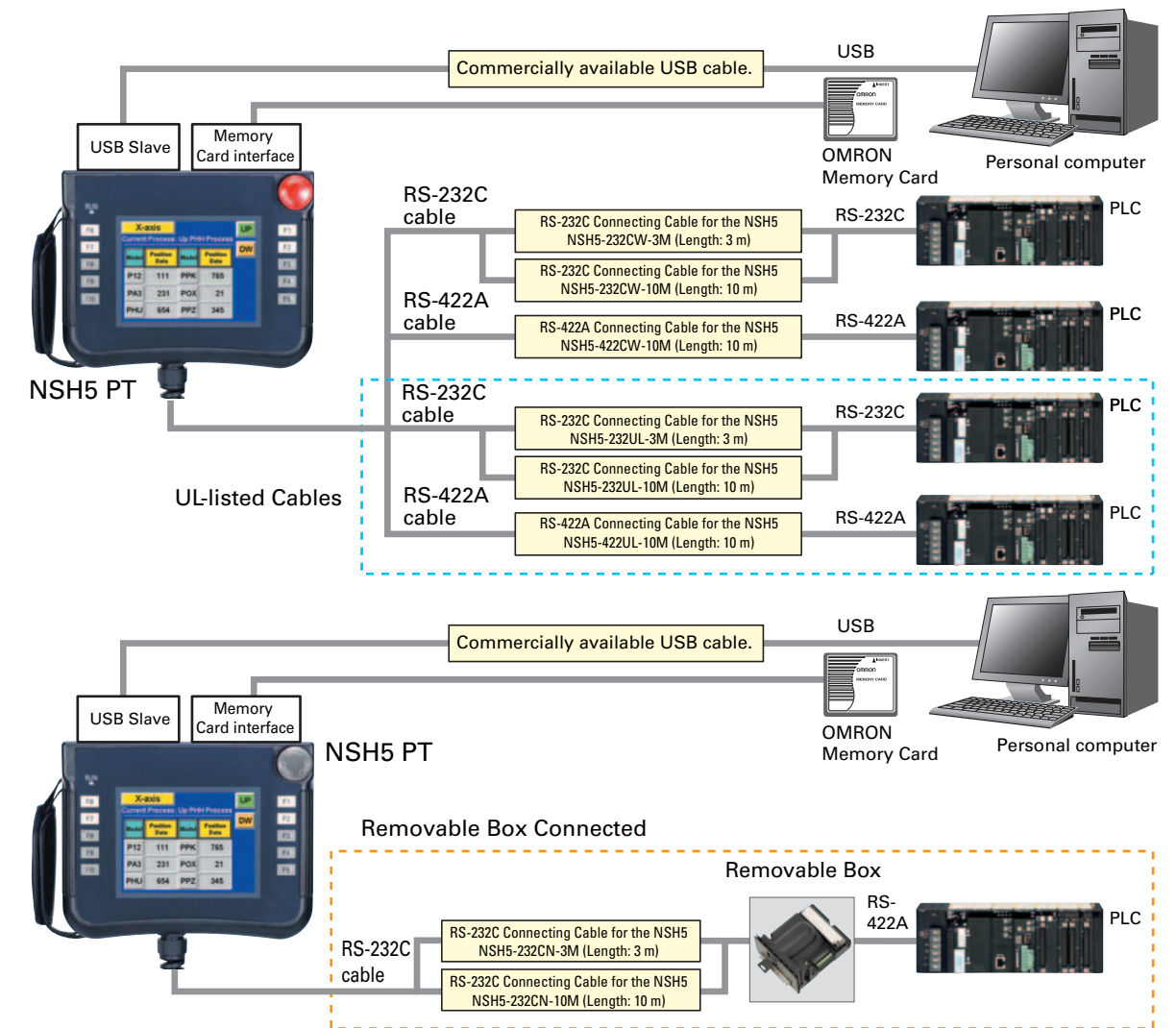

●System Configuration

(Removable Box Connected)



Note: Before removing the NSH5 from the Removable Box, be sure to first turn OFF the power supply key on the Removable Box.

Standard Models

■ Programmable Terminals

Model name	Specifications				Model number	Standards	
	Effective display area	Number of dots	Ethernet	Case color			
NS5-V2 (See note.)	5.7-inch STN monochrome	320 × 240 dots	No	Ivory	NS5-MQ10-V2	UC1, CE, N, L, UL Type4	
				Black	NS5-MQ10B-V2		
			Yes	Ivory	NS5-MQ11-V2		
				Black	NS5-MQ11B-V2		
			No	Ivory	NS5-SQ10-V2		
				Black	NS5-SQ10B-V2		
	Yes		Ivory	NS5-SQ11-V2			
			Black	NS5-SQ11B-V2			
	5.7-inch TFT		No	Ivory	NS5-TQ10-V2		UC1, CE, N, L
				Black	NS5-TQ10B-V2		
			Yes	Ivory	NS5-TQ11-V2		
				Black	NS5-TQ11B-V2		
NS8-V2	8.4-inch TFT	640 × 480 dots	No	Ivory	NS8-TV00-V2	UC1, CE, N, L	
				Black	NS8-TV00B-V2		
			Yes	Ivory	NS8-TV01-V2		
				Black	NS8-TV01B-V2		
NS10-V2	10.4-inch TFT	640 × 480 dots	No	Ivory	NS10-TV00-V2		
				Black	NS10-TV00B-V2		
			Yes	Ivory	NS10-TV01-V2		
				Black	NS10-TV01B-V2		
NS12-V2	12.1-inch TFT	800 × 600 dots	No	Ivory	NS12-TS00-V2	UC1, CE, N, L, UL Type4	
				Black	NS12-TS00B-V2		
			Yes	Ivory	NS12-TS01-V2		
				Black	NS12-TS01B-V2		
NS15-V2	15-inch TFT	1,024 × 768 dots	Yes	Silver	NS15-TX01S-V2		
				Black	NS15-TX01B-V2 NEW		
NSH5-V2 (See note.) Hand-held	5.7-inch STN	320 × 240 dots	No	Black (Emergency stop button: Red)	NSH5-SQR10B-V2		UC, CE
				Black (Stop button: Gray)	NSH5-SQG10B-V2		

Note: As of July 2008, the image memory has been increased to 60 MB.

Production of the NS5-□Q0□(B)-V2 and NSH5-SQ□00B-V2 is scheduled to be discontinued with a transition period of one year.

■ NS-Runtime

Product name	Specifications	Media	Model number	Standards	
NS-Runtime	NS-Runtime Installer, PDF manual, hardware key (See note.)	1 license	CD	NS-NSRCL1	---
		3 licenses		NS-NSRCL3	
		10 licenses		NS-NSRCL10	

Note: A hardware key (USB dongle) is required for NS-Runtime operation.

● System Requirements

Item	Specifications
OS	Windows XP (Service Pack 2 or higher) or Vista
CPU	Celeron, 1.3 GHz
Memory size	HDD: 50 MB min., RAM: 256 MB min., 512 MB recommended. 50 MB is required for the Runtime alone. (An additional 280 MB is required if CX-Server is not already installed.)

■ Programming Devices

Model name	Specifications	Media		Model number	Standards
		Number of licenses	Media		
CX-One FA Integrated Tool Package Ver. 3.□	The CX-One is an integrated tool package that provides programming and monitoring software for OMRON PLCs and components. The CX-One runs on any of the following operating systems: OS: Windows 2000 (Service Pack 3 or higher), XP, or Vista. The CX-Designer can also be ordered individually using the following model number.	1 license (See note 2.)	CD	CXONE-AL01C-V3	---
			DVD (See note 3.)	CXONE-AL01D-V3	
		CX-Designer Ver. 3.□	Screen Designer for NS Series OS: Window 2000 (Service Pack 3 or higher), XP, or Vista. The Ladder Monitor Software is included with CX-Designer version 3.□. Note: The Ladder Monitor Software is used to monitor CS/CJ/CP-series PLC ladder programs from an NS-series PT. A Memory Card and Memory Card Adapter (both sold separately) are required to use the Ladder Monitor Software with the NS8-V1, NS10-V1, or NS12-V1, or with the NS8-V2, NS10-V2, or NS12-V2 with system program version 6.6 or lower.	1 license	

Note 1. CX-Designer version 3.008 or higher is required to use the NS15. Users who purchase CX-One version 3.□ can use the auto-update to update the version.

2. Multiple licenses (3, 10, 30, or 50) are available for CX-One. For details, refer to the *CX-One Catalog* (Cat. No. R134).





3. Before ordering the software on a DVD, be sure that your computer and drive are compatible with the DVD format.

Standard Models

Model name	Specifications	Model number	Standards
Cable (See note.) 	Screen transfer cable for DOS/V (CX-Designer ↔ PT)	Length: 2 m XW2Z-S002	---
	USB Host Cable (For a printer)	Length: 5 m NS-US52	
	USB Host Cable (For a printer)	Length: 2 m NS-US22	
	USB-Serial Conversion Cable	Length: 0.5 m CS1W-CIF31	N
	USB relay cable	Length: 1 m NS-USBEXT-1M	---
NSH5 Cables	RS-422A cable (loose wires + D-Sub 9-pin)	Length: 10 m NSH5-422CW-10M	
	RS-232C cable (loose wires + D-Sub 9-pin)	Length: 3 m NSH5-232CW-3M	
	RS-232C cable (loose wires + D-Sub 9-pin)	Length: 10 m NSH5-232CW-10M	
UL-compliant NSH5 Cable	RS-422A cable (loose wires)	Length: 10 m NSH5-422UL-10M	CU
	RS-232C cable (loose wires + relay cable)	Length: 3 m NSH5-232UL-3M	
	RS-232C cable (loose wires + relay cable)	Length: 10 m NSH5-232UL-10M	
PT-to-PLC Connecting Cable	PT connection: 9 pins PLC connection: 9 pins	Length: 2 m XW2Z-200T	---
		Length: 5 m XW2Z-500T	
	PT connection: 9 pins PLC peripheral port	Length: 2 m XW2Z-200T-2	
		Length: 5 m XW2Z-500T-2	
NSH5 Removable Box Cable	RS-232C Cable (connectors)	Length: 3 m NSH5-232CN-3M	---
		Length: 10 m NSH5-232CN-10M	
NSH5 Removable Box	---	NSH5-AL001	
NSH5 Wall-mounting Bracket	---	NSH5-ATT02	
NSH5 Visor	---	NSH5-ATT01	

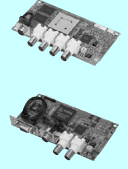
Note: Use an OMRON USB Host Cable to connect an NS-series PT to a printer.
Use a standard USB cable to connect the NS-series PT to a PictBridge-compatible printer.

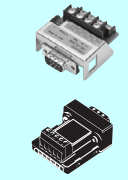
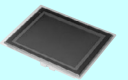
Options

Model name	Specifications	Model number	Standards	
Video Input Unit 	Inputs: 4 channels Signal type: NTSC/PAL	NS-CA001	UC1, CE	
	Input channels: 2 video channels and 1 RGB channel (See note 1.) Signal type: NTSC/PAL	NS-CA002		
Special Cable for the Console	Cable length: 2 m	F150-VKP (2 m)	---	
	Cable length: 5 m	F150-VKP (5 m)		
Controller Link Interface Unit 	For Controller Link Communications	NS-CLK21	UC1, CE	
RS-422A Adapter 	Transmission distance: 500 m total length Note: Use this model when connecting PT models without a V□ suffix. Note: PT models with the V□ suffix can also be connected.	NS-AL002	---	
	Transmission distance: 50 m total length Note: Only PT models with a suffix of V□ are connectable. Use the NS-AL002 to connect models without a V□ suffix.	CJ1W-CIF11	UC1, N, L, CE	
Sheet/Cover (See note 2.) 	Anti-reflection Sheets (5 surface sheets)	NS15	NS15-KBA04	---
		NS12/10	NS12-KBA04	
		NS8	NS7-KBA04	
		NS5	NT30-KBA04	
	Protective Covers (5 pack) (anti-reflection coating)	NS12/10	NS12-KBA05	
		NS8	NS7-KBA05	
		NS5	NT31C-KBA05	
Protective Covers (1 cover included) (Transparent)	NS15	NS15-KBA05N		
Protective Covers (5 covers included) (Transparent)	NS12/10	NS12-KBA05N		
	NS8	NS7-KBA05N		
	NS5	NT31C-KBA05N		
Attachment	NT625C/631/631C Series to NS12/10 Series	NS12-ATT01	---	
	NT625C/631/631C Series to NS12/NS10 Series (Black)	NS12-ATT01B		
	NT610C Series to NS12/10 Series	NS12-ATT02		
	NT620S/620C/600S Series to NS8 Series	NS8-ATT01		
	NT600M/600G/610G/612G Series to NS8 Series	NS8-ATT02		
Memory Card 	128MB	HMC-EF183	L, N, CE	
	256 MB	HMC-EF283	CE	
	512 MB	HMC-EF583		
Memory Card Adapter	---	HMC-AP001		
Replacement Battery	Battery life: 5 years (at 25°C)	CJ1W-BAT01		
Bar Code Reader	CCD handheld bar code reader (RS-232C interface)	V520-RH21-6	---	

Note 1. One screen cannot display two video inputs simultaneously.
2. A Chemical-resistant Cover (NT30-KBA01) is available only for the NS5.

What's New

Compatibility





Screen Design Software

Basic Functions

NS-Runtime

Specifications

Performance/Specifications

Series		NS5-V2												NS8-V2			
Type		5.7-inch Monochrome STN				5.7-inch Color STN				5.7-inch Color TFT				8.4-inch Color TFT			
Appearance																	
Display device		Monochrome LCD				STN color LCD				Color TFT				High-definition TFT color LCD			
Effective display area		Width 117.2 × height 88.4 mm (5.7 inches)												Width 170.9 × height 128.2 mm (8.4 inches)			
Case color		Ivory		Black		Ivory		Black		Ivory		Black		Ivory		Black	
Built-in Ethernet port		No	Yes	No	Yes	No	Yes	No	Yes	No	Yes	No	Yes	No	Yes	No	Yes
Model number		NS5-MQ10-V2	NS5-MQ11-V2	NS5-MQ10B-V2	NS5-MQ11B-V2	NS5-SQ10-V2	NS5-SQ11-V2	NS5-SQ10B-V2	NS5-SQ11B-V2	NS5-TQ10-V2	NS5-TQ11-V2	NS5-TQ10B-V2	NS5-TQ11B-V2	NS8-TV00-V2	NS8-TV01-V2	NS8-TV00B-V2	NS8-TV01B-V2
Display colors		16 gradations				256 colors				256 colors				256 colors			
Number of dots		320 dot horizontal × 240 dot vertical												640 dot horizontal × 480 dot vertical			
View angle		Left/right: 45°, Top: 20°, Bottom: 40°				Left/right: 50°, Top: 45°, Bottom: 50°				Left/right: 70°, Top: 70°, Bottom: 50°				Left/right: 65°, Top: 50°, Bottom: 60°			
Screen data capacity		60 Mbytes												60 Mbytes			
Image data (BMP or JPG images)		16 gradations				4,096 colors				32,768 colors				32,768 colors			
Memory Card		Supported												Supported			
Ladder Monitor function		Not supported												Supported			
Video Input Unit support		Not supported												Supported			
Image displayed via video input		---												260,000 colors			
Controller Link Interface Unit (Wired) support		Not supported												Not supported			
Backlight <small>Note: Contact your nearest OMRON representative to replace the backlight.</small>	Service life	50,000 hours min.				75,000 hours min.				50,000 hours min.				50,000 hours min.			
	Brightness adjustment	There are 3 levels that can be set with the touch panel. Note: The brightness cannot be adjusted much.															
	Backlight error detection	Error is detected automatically, and the RUN indicator flashes green as notification. Note: This function does not indicate that the service life has been reached. It detects when the backlight is not lit due to a disconnection or other errors. Backlight error detection indicates that all backlights (2) are OFF.															
Touch panel (matrix type)	Method	Matrix resistive membrane															
	Number of switches/resolution	300 (20 horizontal × 15 vertical) 16 × 16 dots for each switch												768 (32 horizontal × 24 vertical) 20 × 20 dots for each switch			
	Input	Pressure-sensitive															
	Service life	1,000,000 touch operations.															
Display text	Labels	Can be specified in CX-Designer. Font, style, and size can be specified.															
	Numerals, alarms, and character strings	Scalable Gothic: Magnification: 6 to 255 points Rough: Magnification: 1 × 1, 1 × 2, 2 × 1, 2 × 2, 3 × 3, 4 × 4, 8 × 8 Standard: Magnification: 1 × 1, 1 × 2, 2 × 1, 2 × 2, 3 × 3, 4 × 4, 8 × 8 Fine: Magnification: 1 × 1, 1 × 2, 2 × 1, 2 × 2, 3 × 3, 4 × 4, 8 × 8 7-segment display: Can display only numerals, dates, and times.															
	Supported languages (42 languages)	Scalable Gothic, rough, standard, and fine can be used for 42 languages. Japanese, simplified Chinese, traditional Chinese, Korean, English, French, German, Italian, Portuguese, Spain, Swedish, Dutch, Finnish, Norwegian, Basque, Catalan, Danish, Albanian, Croatian, Czech, Hungarian, Polish, Romanian, Slovak, Slovenian, Bulgarian, Belarusian, Russian, Serbian, Macedonian, Ukrainian, Georgian, Icelandic, Afrikaans, Faroese, Indonesian, Greek, Turkish, Estonian, Latvian, Lithuanian, Thai (supported only with scalable Gothic font)															
	Color	Monochrome, 16 gradations				256 colors											
Text attributes	Font style (only when vector font is specified)	Bold or italic															
	Vertical alignment	Top, center, or bottom															
	Horizontal alignment	Left-justified, centered, or right-justified															
Flicker	Objects supporting flicker	Functional objects: Select from up to 10 types of registered flicker settings. The flicker speed and flicker range can be set. Fixed objects: Select from three flicker types.															

Performance/Specifications

Series		NS5-V2		
Type		5.7-inch Monochrome STN	5.7-inch Color STN	5.7-inch Color TFT
Numerical units and scale settings		1.000 max.		
Alarm/event settings		5,000 max.		
Memory Card	Interface	One ATA-Compact Flash interface slot		
	Functions	Used to transfer and store screen data, store logging data, and store history data. (Alarm/Event History, Operation Log, and Error Log generated during Macro execution).		
Expansion interface		For Expansion Interface Units		
Serial Communications	Port A	Connector	Conforms to EIA RS-232C. D-Sub female 9-pin connector 5-V output (250 mA max.) through pin 6 (See note.) Note: The 5-V outputs of serial ports A and B cannot be used at the same time.	
		Functions	Host (PLC) access: 1:N NT Links (connections with CS/CJ/CP-series PLCs and C200HX/HG/HE(-Z) PLCs), 1:1 NT Links (connections with C Series or CVM1/CV-series PLCs) Direct access to Temperature Controllers using Smart Active Parts: CompoWay/F and bar code reader connections (Read directly from display.)	
	Port B	Connector	Conforms to EIA RS-232C. D-Sub female 9-pin connector 5-V output (250 mA max.) through pin 6 (See note.) The 5-V outputs of serial ports A and B cannot be used at the same time. Note: The 5-V outputs of serial ports A and B cannot be used at the same time.	
		Functions	Host (PLC) access: 1:N NT Links (connections with CS/CJ/CP-series PLCs and C200HX/HG/HE(-Z) PLCs) or 1:1 NT Links (connections with C Series or CVM1/CV-series PLCs) Direct access to Temperature Controllers using Smart Active Parts: CompoWay/F and bar code reader connections (Read directly from display.)	
USB SLAVE Specifications	USB rating	USB1.1		
	Connector	TYPE-B (Slave)		
	Functions	Connection with the CX-Designer (for screen data transfers) Connecting to a PictBridge-compatible Printer Recommended printers: EPSON: PM-G4500, PX-G5300, PX-5600 Canon: PIXUS MX7600, PIXUS MP980/MP630/MP620/MP540/MP480, PIXUS iP4600/iP3600/iP100, PIXUS iX5000, PIXUS Pro9500/Pro9000		
USB HOST Specifications	USB rating	None		
	Connector			
	Functions			
Built-in Ethernet Specifications (NS□-□□□1-V2 only)	Conformance standards	Conforms to IEEE 802.3/Ethernet (10Base-T/100Base-TX).		
	Function	Host (PLC) access and connection with the CX-Designer (for screen data transfers)		
Controller Link (Wired-type) Specifications	Baud rate	---		
	Transmission path	---		
	Functions	---		
Video Input Specifications	Resolution	---		
	Input signal	---		
	Number of video inputs	---		



General Specifications

Series		NS5-V2		
Type		5.7-inch Monochrome STN	5.7-inch Color STN	5.7-inch Color TFT
Rated power supply voltage		24 VDC		
Allowable voltage range		20.4 to 27.6 VDC (24 VDC ±15%)		
Power consumption		25 W max. (15 W max. for the NS5)		
Ambient operating temperature		0 to 50°C (See note on the next page.) Note: The ambient operating temperature is subject to the following restrictions according to the mounting angle. Mounting angle of 0 to 30° to the horizontal: •When no Expansion Units are mounted, the operating temperature range is 0 to 45°C. •When a Video Input Unit or a Controller Link Interface Unit is mounted, the ambient operating temperature is 0 to 35°C. Mounting angle of 30 to 90° to the horizontal: Operating temperature range of 0 to 50°C		
Storage temperature		-20 to 60°C (See note on the next page.)		
Ambient operating humidity		35 to 85% (0 to 40°C) 35 to 60% (40 to 50°C) (with no condensation)		
Operating environment		No corrosive gases.		
Noise immunity		Conforms to IEC61000-4-4, 2 kV (power lines).		
Vibration resistance (during operation)		10 to 57 Hz, 0.075 mm amplitude, 57 to 150 Hz, 9.8 m/s ² 30 min each in X, Y, and Z directions		
Shock resistance (during operation)		147 m/s ² 3 times each in direction of X, Y, and Z		
Weight		1.0 kg max.		
Degree of protection		Front operating panel: Equivalent to IP65 oil-proof type and NEMA4 UL type 4. (Only to NS5) Note: May not be applicable in locations with long-term exposure to oil.		
Ground		Ground to 100 Ω or less.		
Battery life		5 years (at 25°C): Replace battery within 5 days after the battery runs low (indicator lights orange).		
Applicable standards		Certified for conformance to UL 508, UL 1604, EMC Directive, NK, and LR Standards.		

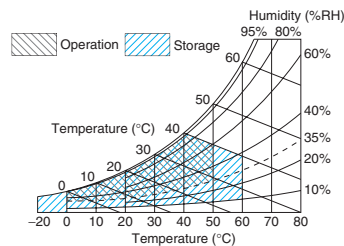
Note: Operate the PT within the temperature and humidity ranges shown in the right diagram.



Performance/Specifications

Series	NSH5-V2	
Type	5.7-inch Color STN (Hand-held Version)	
Appearance	 <p>Emergency stop button (Red)</p>	 <p>Stop button (Gray)</p>
Case color	Black	
Built-in Ethernet port	No	
Model number	NSH5-SQR10B-V2 (Emergency stop button: Red)	NSH5-SQG10B-V2 (Stop button: Gray)
Rated power supply voltage	24 VDC	
Allowable voltage range	20.4 to 27.6VDC (24 VDC \pm 15%)	
Power consumption	10 W max.	
Ambient operating temperature	0 to 40°C	
Storage temperature	-20 to 60°C	
Ambient operating humidity	35% to 85% (0 to 40°C) with no condensation	
Operating environment	No corrosive gases.	
Noise immunity	Common mode: 1,000 Vp-p (between power supply terminals and panel) Normal mode: 300 Vp-p Pulse width: 100 ns to 1 μ s, Rise time: 1-ns pulse	
Vibration resistance (during operation)	10 to 57 Hz, 0.075 mm amplitude, 57 to 150 Hz, 9.8 m/s ² 30 min each in X, Y, and Z directions	
Shock resistance (during operation)	147 m/s ² 3 times each in direction of X, Y, and Z	
Weight	1 kg max.	
Degree of protection	Equivalent to IP65.	
Ground	Ground to 100 Ω or less.	
Battery life	5 years (at 25°C): Replace battery within 5 days after the battery runs low (indicator lights orange).	
Applicable standards	Certified for conformance to UL 508, EMC Directive, and EN 60204-1.	

■ Supported PLCs

● Link Connection

PLC series	PLC model name	Model number	Specifications
C Series	CQM1	CQM1-CPU□□-V1	With RS-232C connector (9-pin type)
	CQM1H	CQM1H-CPU□□	
	CPM1	CPM1-□□CDR-□+CPM1-CIF01	Connect to peripheral port.
	CPM1A	CPM1A-□□CD□-□+CPM1-CIF01	
	CPM2A	CPM2A-□□CD□□-□+CPM1-CIF01	Connect to RS-232C or peripheral port.
	CPM2C	CPM2C-10/20□□□□□□-□ (See note 2.)	
	C200HS	C200HS-CPU□□	With RS-232C connector (9-pin type)
	C200HE(-Z)	C200HE-CPU□□(-Z) (See note 3.)	
C200HG(-Z)	C200HG-CPU□□(-Z) (See note 3.)		
C200HX(-Z)	C200HX-CPU□□(-Z) (See note 3.)		
CVM1/CV Series	CV500/1000/2000	CV500/1000/2000-CPU□□-V1	With RS-232C connector (switching/9-pin type)
	CVM1	CVM1-CPU□□-V2	

Note 1. NS-Runtime is supported for only the CS/CJ/CP/CV-series PLCs (Peripheral Bus (toolbus), Host Link, and Ethernet) and the CJ2 (Peripheral Bus (toolbus) and Ethernet). It is not supported for an EtherNet/IP connection.

- Use an Adapter Cable (CPM2C-CN111 or CS1W-CN114/118), CPM1-CIF01 RS-232C Adapter, or CPM1-CIF11 RS-422A Adapter to connect.
- A C200HW-COM02(-V1), C200HW-COM04(-V1), C200HW-COM05(-V1), or C200HW-COM06(-V1) Communications Board is required.

● 1:N NT Link Connection

PLC series	PLC model name	Model number	Specifications
CS series	CS1G	CS1G-CPU□□(-V1) (See note 2.) CS1G-CPU□□H (See note 2.)	With RS-232C connector (9-pin type)
	CS1H	CS1H-CPU□□(-V1) (See note 2.) CS1H-CPU63H/CPU64H/CPU65H/CPU66H/CPU67H (See note 2.)	
		CS1D	
	CJ series	CJ1G	
Loop-control CPU Unit		CJ1G-CPU□□P	
CJ1H		CJ1H-CPU□□H (See note 3.)	
CJ1M		CJ1M-CPU□□ (-ETN)	
CP series	CJ2H	CJ2H-CPU64/CPU65/CPU66/CPU67/CPU68(-EIP)	
	CP1H	CP1H-□□ (See note 4.)	Connect to the RS-232C connector of a CP1W-CIF01 RS-232C Option Board.
	CP1L	CP1L-M□□/□□□ (See note 4.)	
CP1E	CP1E-N□□□□-□ (See notes 4 and 5.)	With RS-232C connector (9-pin type)	
C series	CQM1H	CQM1H-CPU61/51 with a CQM1H-SCB41 Serial Communications Board	With RS-232C connector (switching/9-pin type)
	C200HE(-Z)	C200HE-CPU32(-Z) (See note 6.)/CPU42(-Z)	
	C200HG(-Z)	C200HG-CPU33(-Z) (See note 6.)/CPU43(-Z)/CPU53(-Z) (See note 6.)/CPU63(-Z)	
	C200HX(-Z)	C200HX-CPU34(-Z) (See note 6.)/CPU44(-Z)/CPU54(-Z) (See note 6.)/CPU64(-Z)/CPU65-Z/CPU85-Z	

Note 1. NS-Runtime is supported for only the CS/CJ/CP/CV-series PLCs (Peripheral Bus (toolbus), Host Link, and Ethernet) and the CJ2 (Peripheral Bus (toolbus) and Ethernet).

- Connection is also possible to a CS1W-SCB□□-V1 Serial Communications Board or CS1W-SCU□□-V1 Serial Communications Unit.
- Connection is also possible to the CJ1W-SCU□□-V1 Serial Communications Unit.
- SPMA via a PLC is not supported when a CP-series PLC is connected. (SPMA via an NS-series PT is supported with a CP-series PLC.)
- The machine monitor function and switch box function are not supported when a CP1E PLC is connected.
- A C200HW-COM02/COM04/COM05/COM06(-V1) Communications Board is required.

● Connecting by Host Link

PLC series	PLC model name	Model number	Specifications
C series	CPM1	CPM1-□□CDR-□/CPM1A-□□CD□-□	RS-232C or RS-422A adapter connected to peripheral port
	CPM2A	CPM2A-□□CD□□-□	With RS-232C connector (9-pin type)
	CPM2C	CPM2C-10/20□□□□□□-□	Communications connectors include both a peripheral port and RS-232C port (branching possible through CPM2C-CN111 Conversion Cable). Used as separate peripheral and RS-232C ports through CS1WCN114/118 Conversion Cable.
	CQM1	CQM1-CPU□□-V1	With RS-232C connector (9-pin type)
	CQM1H	CQM1H-CPU□□	With RS-232C connector (9-pin type) (CQM1H-CPU11: peripheral port only)
	C200HS	C200HS-CPU□□	With RS-232C connector (switching/9-pin type)
	C200HE(-Z)	C200HE-CPU□□(-Z) (See note 2.)	
	C200HG(-Z)	C200HG-CPU□□(-Z) (See note 2.)	
C200HX(-Z)	C200HX-CPU34 (-Z) (See note 2.)/CPU44 (-Z)/CPU54 (-Z) (See note 2.)/CPU64 (-Z)/CPU65-Z/CPU85-Z		
CS series	CS1G	CS1G-CPU□□(-V1) (See note 3.) CS1G-CPU□□H (See note 3.)	With RS-232C connector (9-pin type)
	CS1H	CS1H-CPU□□(-V1) (See note 3.) CS1H-CPU□□H (See note 3.)	
		CJ1G	
CJ series	Loop-control CPU Unit	CJ1G-CPU□□P	
	CJ1H	CJ1H-CPU□□H (See note 4.)	
	CJ1M	CJ1M-CPU□□ (-ETN)	
	CJ2H	CJ2H-CPU64/CPU65/CPU66/CPU67/CPU68(-EIP)	
CP series	CP1H	CP1H-□□	Connect to the RS-232C connector of a CP1W-CIF01 RS-232C Option Board.
	CP1L	CP1L-M□□/□□□	
	CP1E	CP1E-N□□□□-□	With RS-232C connector (9-pin type)
CVM1/CV series	CV500/1000/2000	CV500-CPU01-V1/CV1000-CPU01-V1/CV2000-CPU01-V1	With RS-232C connector (switching/9-pin type)
	CVM1	CVM1-CPU□□-V2	

Note 1. NS-Runtime is supported for only the CS/CJ/CP/CV-series PLCs (Peripheral Bus (toolbus), Host Link, and Ethernet) and the CJ2 (Peripheral Bus (toolbus) and Ethernet).

- A C200HW-COM02/COM04/COM05/COM06(-V1) Communications Board is required.
- Connection is also possible to a CS1W-SCB□□-V1 Serial Communications Board or CS1W-SCU□□-V1 Serial Communications Unit.
- Connection is also possible to the CJ1W-SCU□□-V1 Serial Communications Unit.

Connectable Devices

Connecting to Another Company's PLC

Manufacturer	Series	CPU	Communication Unit/Adapter/Board	Connection diagram	
Mitsubishi Electric	A Series	A1SHCPU A2USCPU A2USHCPU-S1	Computer Link Unit A1SJ71UC24-R□ A1SJ71UC24-PRF		1:1
		A2ACPU	Computer Link Unit AJ71UC24		
	FX Series	FX0N FX1S FX1N FX1NC FX2N FX3UC	Communication special adapter FX3U-232-ADP FX2NC-232ADP FX0N-232-ADP		1:1
			Communication expansion board FX□□-232-BD		
	Q/QnA Series	Q00CPU Q01CPU	RS-232C port on the CPU Module		1:1
Q2ASCPU Q2ASCPU-S1 Q2ASHCPU Q2ASHCPU-S1		Serial Communications Module A1SJ71QC24N			
Yokogawa Electric	FA-M3(R) Series	F3SC23-1F F3SP21-0N F3SP28-3S F3SP58-6S F3SP67-6S	CPU built-in RS-232C port Personal Computer Link Module F3LC11-1F F3LC12-1F F3LC11-2F	RS-232C RS-232C, RS-422A/485	1:1
Siemens	S7-300 Series	CPU313 CPU315-2DP CPU317-2PN/DP	SIMATIC S7 HMI Adapter 6ES7 972-0CA1□-0XA0		1:1
Rockwell (Allen-Bradley)	SLC500	SLC5/03 SLC5/04 SLC5/05	RS-232C port on the CPU Module	RS-232C	1:1
	MicroLogix	MicroLogix 1500	RS-232C port on the CPU Module	RS-232C	1:1
	ControlLogix	Logix5555	RS-232C port on the CPU Module	RS-232C	1:1
	CompactLogix	1769-L31	RS-232C port on the CPU Module	RS-232C	1:1
	PLC-5	PLC-5/20	RS-232C port or RS-485 port on the CPU Module	RS-232C/RS-485 (4-wire)	1:1

■ Connectable Motion Controllers

● Trajexia

Series	CPU	Communication Unit	Connection
Trajexia	TJ1-MC16 TJ1-MC04	Ethernet port on the Controller	Ethernet

● Connecting to Another Company's Motion Controllers

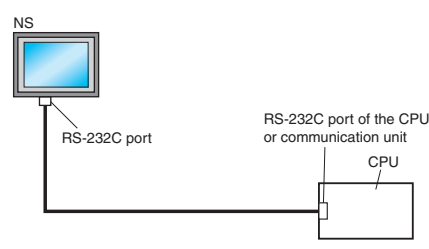
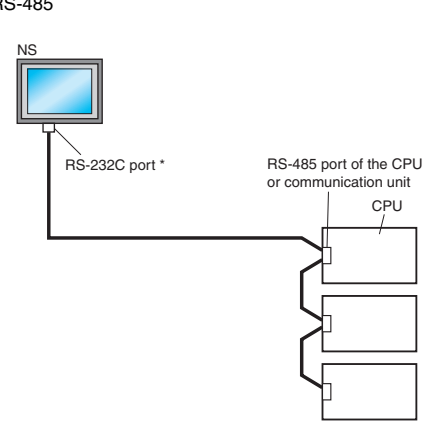
Manufacturer	Series	CPU	Communications Unit/Adapter/Board	Connection
Yaskawa Electric	MP900 Series	MP920	(Use the RS-232C port or RS-485 port on the Machine Controller)	<p>RS-232C</p>  <p>1:1</p>
	MP2000 Series	MP2200	Serial Communication Module 2171F-01	<p>RS-485</p>  <p>1:N</p> <p>* To connect using RS-485, a converter (e.g. NS-AL002) is required. Up to 32 controllers can be connected when using RS-485.</p>

■ Connectable Inverters

Series	Communication Unit	Connection
3G3MV (Varispeed)	(Use the RS-422/485 terminal on the Inverter)	RS-422/RS-485 (4-wire)/RS-485 (2-wire)
3G3JV (Varispeed)	3G3JV-PSI485J	

■ Connectable Temperature Controllers

The following Temperature Controllers can be connected directly to an NS-series PT (See note.).

Unit name	Series	Model	Remarks
Modular Temperature Controller	EJ1	EJ1-EDU End Unit	SAP screens are available.
Modular Temperature Controller	E5ZN	E5ZN-SCT24S Terminal Unit	
Digital Controller	E5AR	E5AR-□□□□□□□□-FLK	
	E5ER	E5ER-□□□□□□□□-FLK	
Temperature Controller (Digital Controller)	E5AN/E5EN/E5CN (Basic Model)	E5CN-□□□□□T-FLK Multi-input (Thermocouple/Resistance Thermometer) Type	
		E5CN-□□□□□L-FLK Analog Input Type	
		E5EN-□□□□□T-FLK Multi-input (Thermocouple/Resistance Thermometer) Type	
		E5EN-□□□□□L-FLK Analog Input Type	
	E5AN-H/E5EN-H/E5CN-H (Advanced Model)	E5AN-□□□□□T-FLK Multi-input (Thermocouple/Resistance Thermometer) Type	
		E5AN-□□□□□L-FLK Analog Input Type	
		E5CN-H□□□□□□□□-FLK Universal-input Model	
	E5GN	E5EN-H□□□□□□□□-FLK Universal-input Model	
		E5AN-H□□□□□□□□-FLK Universal-input Model	
		E5GN-□□□□TC-FLK Thermocouple Input Type	
		E5GN-□□□□P-FLK Resistance Thermometer Input Type	

Note: The NS-Runtime cannot be connected directly to a Temperature Controller.

Connection Configurations

■ Transferring Screens (Connecting the CX-Designer and PT)

● Connecting to the Computer's RS-232C Port

Use a XW2Z-S002 Cable for screen transfers.

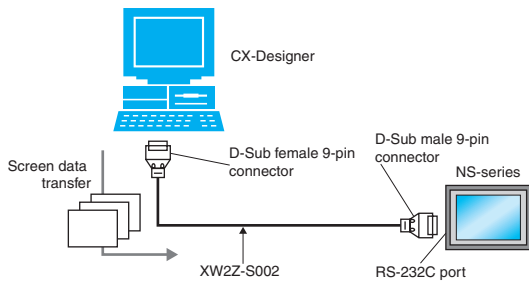

Connecting to the Computer's USB Port

Use a CS1W-CIF31 USB-Serial Conversion Cable and XW2Z-S002 Cable for screen transfers.

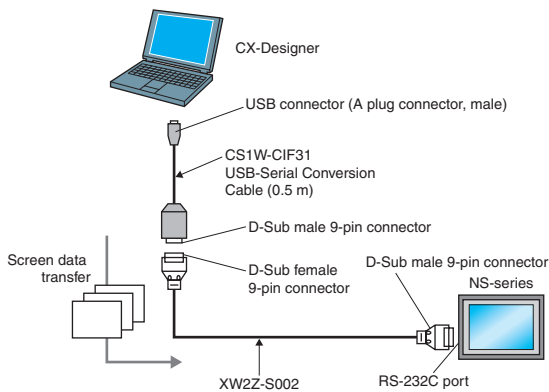

A commercially available USB cable can be used as well. *

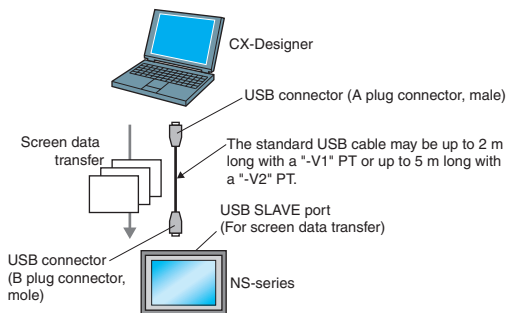

* Commercially available USB cables cannot be used for the NS main units of which the lot. No. is prior to 0325 (made on Feb. 3, 2005).

● Connecting to the Computer's LAN (Ethernet) Port

Connecting Directly (1:1) to the Computer

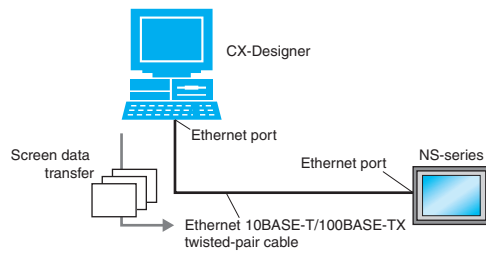

Connecting to the Computer through a Hub

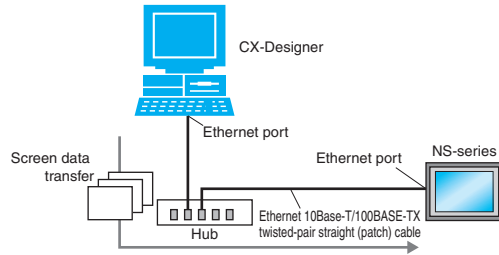

Note: An NS-series PT can also connect to a network configured for 10Base-5 when using a hub and transceiver set for 10Base-5 communications.

● Connecting through a PLC

If the PLC is a CS/CJ-series PLC, screen data can be transferred to an NS-series PT through the PLC. *

Using a Serial → Serial Connection

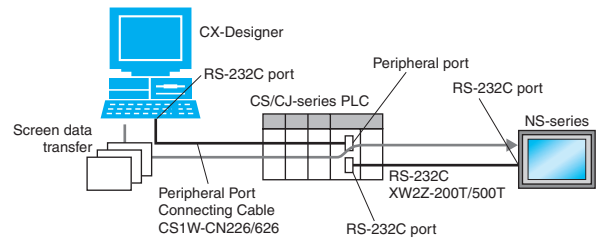

Using an Ethernet → Serial Connection

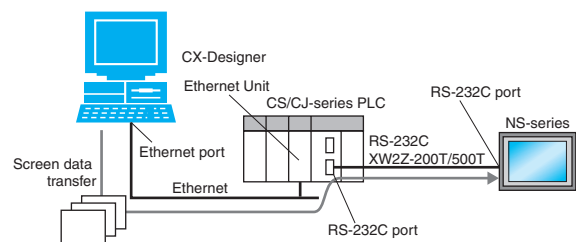

* Not available for the CPU units of which the lot No. is prior to 03020.

Connection Configurations

■ Operation (Connection between NS-series PT and PLC)

● Using a Serial Connection

When connecting to a CS/CJ-series PLC's RS-232C port

Use an XW2Z-200T/500T Cable between the PT and PLC.

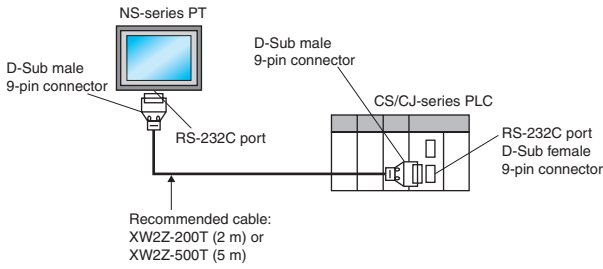

When connecting to a CS/CJ-series PLC's peripheral port

Use an XW2Z-200T-2/500T-2 Cable between the PT and PLC.

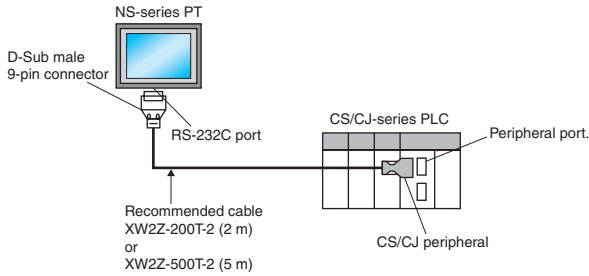

● Using an Ethernet Connection

Connecting Directly (1:1) to the Computer

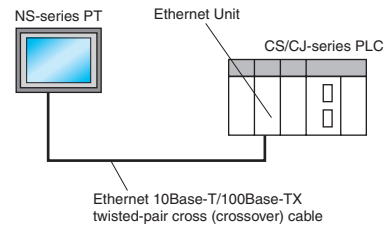

Connecting to the Computer via a Hub

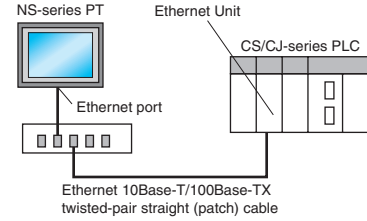

Note: An NS-series PT can also connect to a network configured for 10Base-5 when using a hub and transceiver set for 10Base-5 communications.

In addition, the NS-series PT can be connected through Controller Link by mounting an NS-CLK21 Controller Link Interface Unit to the PT.

Smart Active Parts (SAP) Library Contents

■ For monitor setting

More than 3,000 Library parts (Smart Active Parts) are available, which can directly access OMRON PLCs and components. The objects can just be pasted from the Smart Active Parts (SAP Library) Library to the screen; it is completely unnecessary to create screens and ladder programming.

The following Smart Active Parts are provided on the CX-One/CX-Designer.

● For CS/CJ CPU Unit

Error Log Monitor, Online Battery Change Button, etc.

● For Serial Communications Boards/Units

Communications Status Displays (Error Monitor), Ports Settings, etc.

● For Ethernet Units/CLK Units

Network Status Displays (Error Monitor and Network Node Status), etc.

● For MC/MCH Unit

JOG Running, Search Zero Position, Program Running, Error Displays, I/O Status Monitor, PV Monitor, etc.

● For NC/NCF Unit

JOG Running, Direct Running, Memory Running (NC Only), Error Displays I/O Status Monitor, PV Monitor, etc.

● For Wireless Terminals for WT30

Monitoring Slave Operating Status in a Wireless Environment

● For Servo (R88D-WT, R7D-AP) (See note 1.)

PV Monitor, Parameter Settings, Error Displays, Driver Information Displays, I/O Status Monitor, etc.

● For Inverters (See note 1.)

Rotation Speed/Monitoring Output Frequency, Other Parameter Settings, etc.

● For DeviceNet DRT2

DRT2 Maintenance/Status Information, IN/OUT Information, etc.

● For Temperature Controllers (E5□R, E5ZN, E5□N, EJ1 and CJ1W-TC) (See note 2.)

Operation Monitor, PID Settings, SP Settings, Alarm Settings, Input Shift Settings, etc.

● For Sensors (E3X-DRT)

Threshold Settings, Monitoring Light Reception Levels, etc.

● For the SmartSlice GRT1 Series

Communications Unit Status, Warning/Alarm Flags, Network Joining/Leaving Status

● For CompoNet

Master/Slave Monitor, Maintenance Information, Analog I/O Monitor, IN/OUT Information Monitor, etc.

● For Multi-point Power Controllers (G3ZA)

Process Variable Read, Status Read, Heater Current Read, Manipulated Variable Write, etc.

● For NE1A Safety Network Controllers and DST1 Safety I/O Terminals

Maintenance Information, IN/OUT Information Monitor, Error Status Information, etc.

Note 1. Smart Active Parts require a Serial Communications Units/Boards (version 1.2 or later).

Note 2. The NS-Runtime cannot be connected directly to a Temperature Controller.

■ For Troubleshooter

A Troubleshooter SAP Library is available to troubleshoot each Unit in the PLC. When an error occurs in a Unit, the Troubleshooter SAP Library provides an easy-to-understand explanation of the cause of the error as well as the countermeasures.

The CX-One/CX-Designer includes the following Troubleshooter SAP library as standard.

● DeviceNet unit

● NC unit

● NCF unit

● Standard I/O unit

● Analog Input / Output / I/O unit

● SCU unit

● High speed counter unit

● CLK unit

● ID sensor unit

Troubleshooter SAP for a Position Control Unit

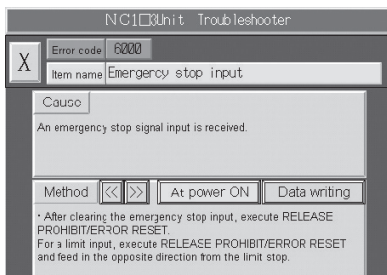

Troubleshooter SAP for Basic I/O Unit

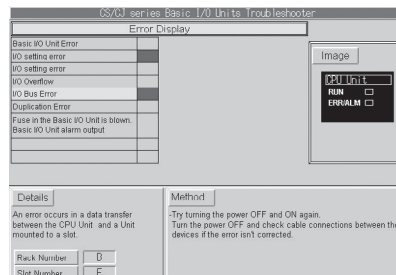

Dimensions

(Units: mm)

NS15

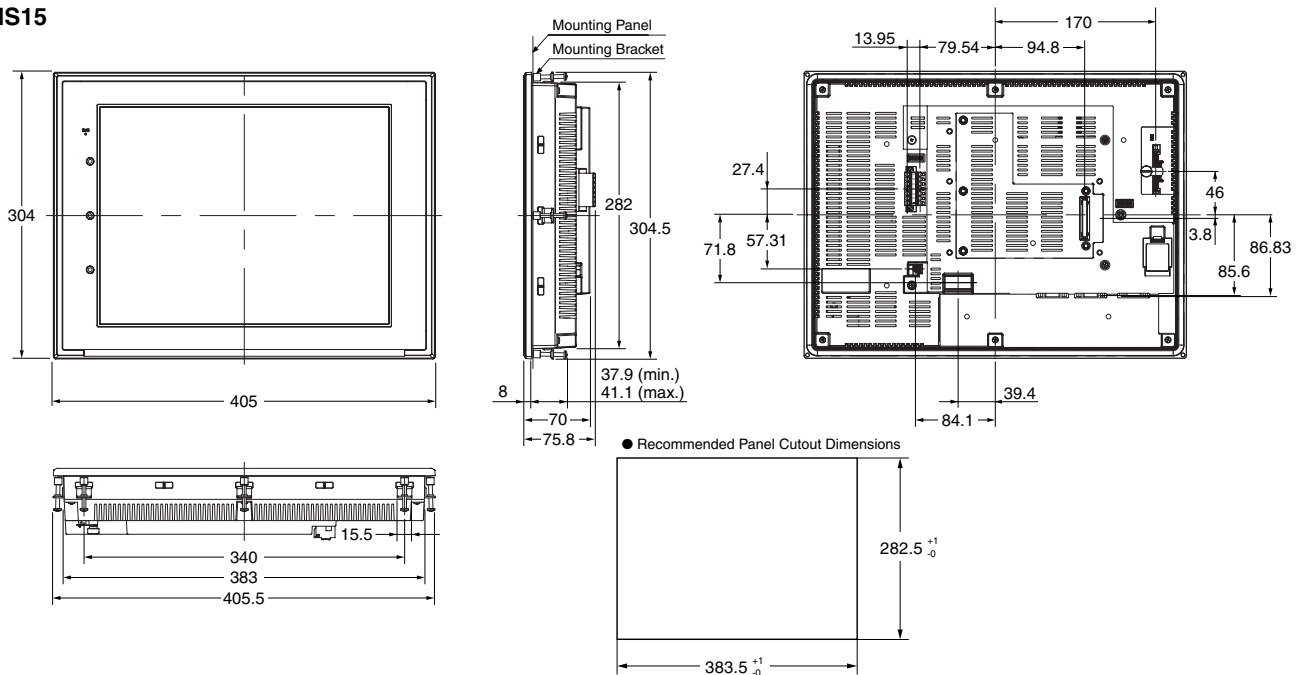

NS12/10

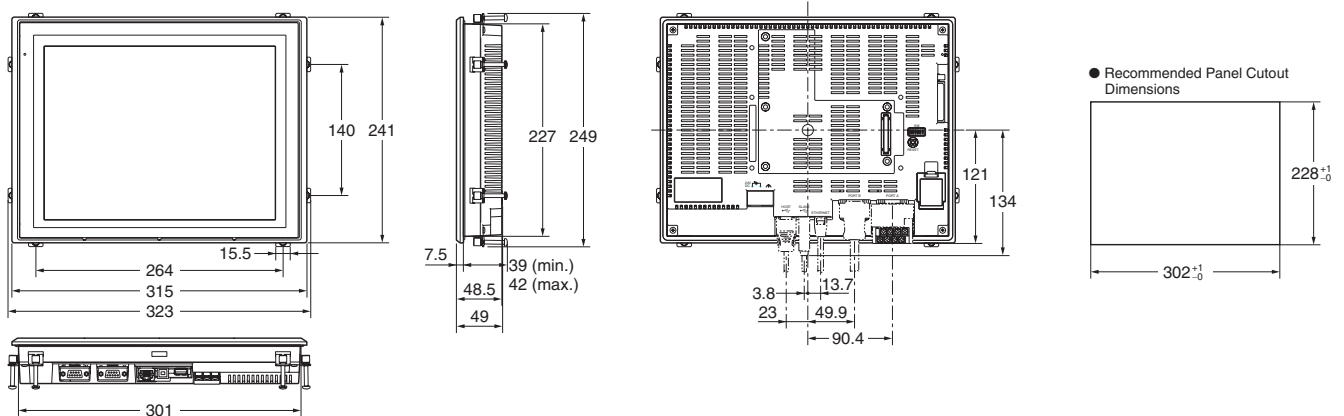

NS8

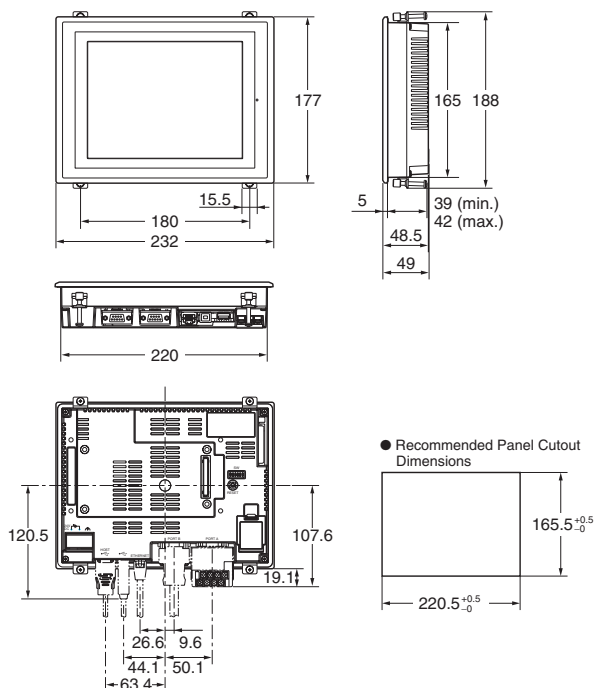

NS5

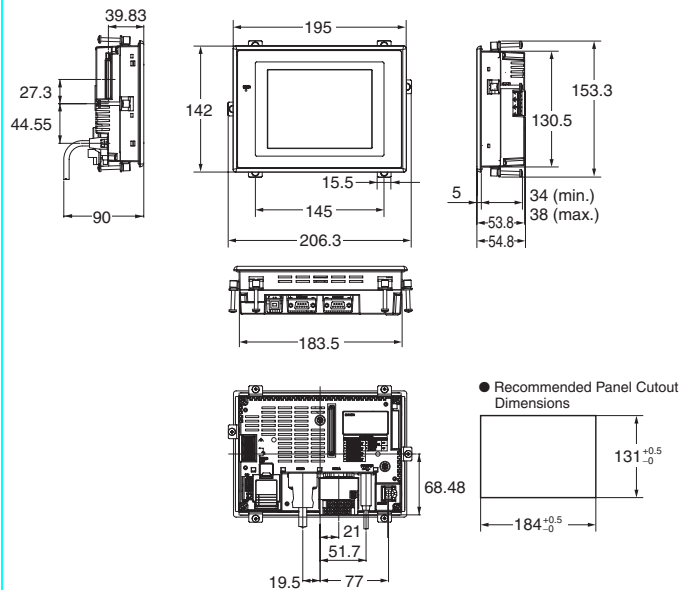

(Units: mm)

Hand-held NS5

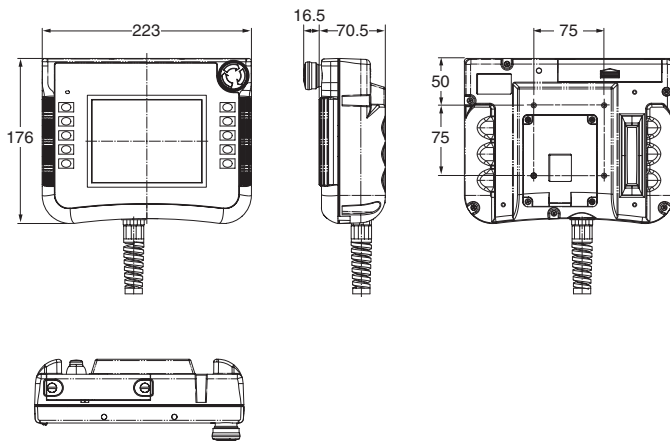

NS-CA001 Video Input Unit

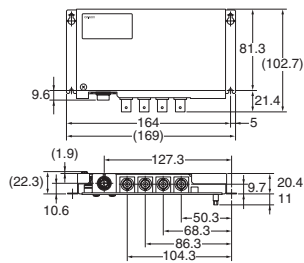

NS-CA002 Video Input Unit

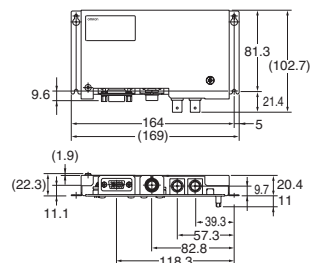

NS-CLK21 Controller Link Interface Unit

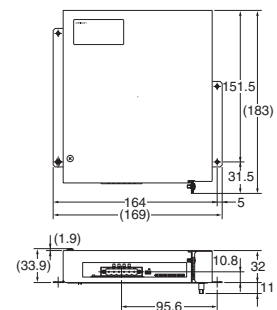

What's New

Compatibility

Screen Design
Software

Basic Functions

NS-Runtime

Specifications

Ordering Information

● International Standards

- The standards are abbreviated as follows: U: UL, U1: UL (Class I Division 2 Products for Hazardous Locations), C: CSA, UC: cULus, UC1: cULus (Class I Division 2 Products for Hazardous Locations), CU: cUL, N: NK, L: Lloyd, and CE: EC Directives.
- Contact your OMRON representative for further details and applicable conditions for these standards.

● EC Directives

The EC Directives applicable to PTs include the EMC Directives. OMRON complies with these directives as described below.

● EMC Directives

Applicable Standards EMI: EN61131-2
EN61000-6-4
EMS: EN61131-2
EN61000-6-2

PTs are electrical devices that are incorporated in machines and manufacturing installations. OMRON PTs conform to the related EMC standards so that the devices and machines into which they are built can more easily conform to EMC standards. The actual PTs have been checked to ensure conformity to EMC standards. Whether these standards are satisfied for the actual system, however, must be checked by the customer.

EMS-related performance will vary depending on the configuration, wiring, and other conditions of the equipment or control panel in which the PT is installed. The customer must, therefore, perform final checks to confirm that the overall machine or device conforms to EMC standards.

The applicable EMS standards depends on the product.

Read and Understand this Catalog

Please read and understand this catalog before purchasing the product. Please consult your OMRON representative if you have any questions or comments.

Warranty and Limitations of Liability

WARRANTY

OMRON's exclusive warranty is that the products are free from defects in materials and workmanship for a period of one year (or other period if specified) from date of sale by OMRON.

OMRON MAKES NO WARRANTY OR REPRESENTATION, EXPRESS OR IMPLIED, REGARDING NON-INFRINGEMENT, MERCHANTABILITY, OR FITNESS FOR PARTICULAR PURPOSE OF THE PRODUCTS. ANY BUYER OR USER ACKNOWLEDGES THAT THE BUYER OR USER ALONE HAS DETERMINED THAT THE PRODUCTS WILL SUITABLY MEET THE REQUIREMENTS OF THEIR INTENDED USE. OMRON DISCLAIMS ALL OTHER WARRANTIES, EXPRESS OR IMPLIED.

LIMITATIONS OF LIABILITY

OMRON SHALL NOT BE RESPONSIBLE FOR SPECIAL, INDIRECT, OR CONSEQUENTIAL DAMAGES, LOSS OF PROFITS OR COMMERCIAL LOSS IN ANY WAY CONNECTED WITH THE PRODUCTS, WHETHER SUCH CLAIM IS BASED ON CONTRACT, WARRANTY, NEGLIGENCE, OR STRICT LIABILITY.

In no event shall the responsibility of OMRON for any act exceed the individual price of the product on which liability is asserted.

IN NO EVENT SHALL OMRON BE RESPONSIBLE FOR WARRANTY, REPAIR, OR OTHER CLAIMS REGARDING THE PRODUCTS UNLESS OMRON'S ANALYSIS CONFIRMS THAT THE PRODUCTS WERE PROPERLY HANDLED, STORED, INSTALLED, AND MAINTAINED AND NOT SUBJECT TO CONTAMINATION, ABUSE, MISUSE, OR INAPPROPRIATE MODIFICATION OR REPAIR.

Application Considerations

SUITABILITY FOR USE

OMRON shall not be responsible for conformity with any standards, codes, or regulations that apply to the combination of the product in the customer's application or use of the product.

Take all necessary steps to determine the suitability of the product for the systems, machines, and equipment with which it will be used.

Know and observe all prohibitions of use applicable to this product.

NEVER USE THE PRODUCT FOR AN APPLICATION INVOLVING SERIOUS RISK TO LIFE OR PROPERTY WITHOUT ENSURING THAT THE SYSTEM AS A WHOLE HAS BEEN DESIGNED TO ADDRESS THE RISKS, AND THAT THE OMRON PRODUCT IS PROPERLY RATED AND INSTALLED FOR THE INTENDED USE WITHIN THE OVERALL EQUIPMENT OR SYSTEM.

PROGRAMMABLE PRODUCTS

OMRON shall not be responsible for the user's programming of a programmable product, or any consequence thereof.

Disclaimers

CHANGE IN SPECIFICATIONS

Product specifications and accessories may be changed at any time based on improvements and other reasons. Consult with your OMRON representative at any time to confirm actual specifications of purchased product.

DIMENSIONS AND WEIGHTS

Dimensions and weights are nominal and are not to be used for manufacturing purposes, even when tolerances are shown.

PERFORMANCE DATA

Performance data given in this catalog is provided as a guide for the user in determining suitability and does not constitute a warranty. It may represent the result of OMRON's test conditions, and the users must correlate it to actual application requirements. Actual performance is subject to the OMRON Warranty and Limitations of Liability.

Note: Do not use this document to operate the Unit.

OMRON Corporation
Industrial Automation Company
Control Devices Division H.Q.
Automation & Drive Division
Automation Department 1

Shiokoji Horikawa, Shimogyo-ku,
Kyoto, 600-8530 Japan
Tel: (81) 75-344-7084/Fax: (81) 75-344-7149

Regional Headquarters
OMRON EUROPE B.V.
Wegalaan 67-69-2132 JD Hoofddorp
The Netherlands
Tel: (31)2356-81-300/Fax: (31)2356-81-388

OMRON Industrial Automation Global: www.ia.omron.com

OMRON ELECTRONICS LLC
One Commerce Drive Schaumburg,
IL 60173-5302 U.S.A.
Tel: (1) 847-843-7900/Fax: (1) 847-843-7787

OMRON ASIA PACIFIC PTE. LTD.
No. 438A Alexandra Road # 05-05/08 (Lobby 2),
Alexandra Technopark, Singapore 119967
Tel: (65) 6835-3011/Fax: (65) 6835-2711

OMRON (CHINA) CO., LTD.
Room 2211, Bank of China Tower,
200 Yin Cheng Zhong Road,
PuDong New Area, Shanghai, 200120, China
Tel: (86) 21-5037-2222/Fax: (86) 21-5037-2200

Authorized Distributor:

© OMRON Corporation 2006 All Rights Reserved.
In the interest of product improvement,
specifications are subject to change without notice.

Cat. No. V405-E1-08

Printed in Japan
0709 (1206)