

## SIMATIC Industrial PC

### Panel Drivers and Tools PDT V1.3 for IFP ETH with resistive single-touch screen

Operating Manual

Preface

---

Panel Drivers and Tools  
software

---

1

IPC Configuration Center

---

2

Software description

---

3

Technical support



---

A

## Legal information

### Warning notice system

This manual contains notices you have to observe in order to ensure your personal safety, as well as to prevent damage to property. The notices referring to your personal safety are highlighted in the manual by a safety alert symbol, notices referring only to property damage have no safety alert symbol. These notices shown below are graded according to the degree of danger.

 <b>DANGER</b>
indicates that death or severe personal injury <b>will</b> result if proper precautions are not taken.
 <b>WARNING</b>
indicates that death or severe personal injury <b>may</b> result if proper precautions are not taken.
 <b>CAUTION</b>
indicates that minor personal injury can result if proper precautions are not taken.
<b>NOTICE</b>
indicates that property damage can result if proper precautions are not taken.

If more than one degree of danger is present, the warning notice representing the highest degree of danger will be used. A notice warning of injury to persons with a safety alert symbol may also include a warning relating to property damage.

### Qualified Personnel

The product/system described in this documentation may be operated only by **personnel qualified** for the specific task in accordance with the relevant documentation, in particular its warning notices and safety instructions. Qualified personnel are those who, based on their training and experience, are capable of identifying risks and avoiding potential hazards when working with these products/systems.

### Proper use of Siemens products

Note the following:

 <b>WARNING</b>
Siemens products may only be used for the applications described in the catalog and in the relevant technical documentation. If products and components from other manufacturers are used, these must be recommended or approved by Siemens. Proper transport, storage, installation, assembly, commissioning, operation and maintenance are required to ensure that the products operate safely and without any problems. The permissible ambient conditions must be complied with. The information in the relevant documentation must be observed.

### Trademarks

All names identified by ® are registered trademarks of Siemens AG. The remaining trademarks in this publication may be trademarks whose use by third parties for their own purposes could violate the rights of the owner.

### Disclaimer of Liability

We have reviewed the contents of this publication to ensure consistency with the hardware and software described. Since variance cannot be precluded entirely, we cannot guarantee full consistency. However, the information in this publication is reviewed regularly and any necessary corrections are included in subsequent editions.

# Preface

## Preface IFP ETH ST

This operating manual is valid for the "SIMATIC IPC Panel Drivers and Tools" PDT software on a PC to which Ethernet monitors with resistive single-touch screen are connected, i.e. for the following devices:

- SIMATIC IPC
- SIMATIC IFP ETH ST

This operating manual describes the installation of the software PDT and the configuration of devices via the SIMATIC IPC Configuration Center.

The information in this documentation takes precedence over statements in the basic operating instructions, the release notes and online help.

## Conventions

The following generic terms are used in this document for product names and device type names:

Long form	Generic term
SIMATIC IFP, Industrial Flat Panel	IFP, device
SIMATIC IFP ETH	IFP, Ethernet Monitor
ETH Touch, ETH Singletouch, ETHT	ETH ST
SIMATIC IPC, industrial PC	IPC, PC, device
SIMATIC IPCx77D, SIMATIC IPCx77E	Panel PC
SIMATIC IPCx27D, SIMATIC IPCx27E	Box PC
Windows Embedded Standard 7E, 7P	WES7E, WES7P
Microsoft Windows 7 Ultimate	Windows 7
SIMATIC IPC Panel Drivers and Tools	PDT, Panel Drivers and Tools
SIMATIC IPC Configuration Center	ICC *, Configuration Center

\* ICC is also the name of the Desktop symbol.

## Style conventions

Style convention	Scope
"OK"	<ul style="list-style-type: none"><li>• User interface terms, for example, dialog names, tabs, buttons, menu commands</li><li>• Required inputs, for example, limits, tag values.</li><li>• Path information</li></ul>
"File > Edit"	Operator actions, for example, menu commands, shortcut menu commands.
<F1>, <Alt+P>	Keyboard operation

## Figures

This document contains figures of the software described. The figures can deviate slightly from the supplied software.

## Trademarks

The following designations marked with the symbol ® are registered trademarks of Siemens AG:

- SIMATIC®; SIMATIC HMI®; SIMATIC Industrial Flat Panel®; SIMATIC IPC®
- WinCC®

## History

The following earlier release versions of these operating instructions have been published:

<b>Edition</b>	<b>Comment</b>
04/2016	First edition V1.1
01/2017	V1.2: Expansion by Touch/Key devices with resistive single touch screen, "Information" tab, IFP ETH commissioning, amendments
03/2018	V1.3: Initial commissioning simplified, operation with multiple monitors and problem solution added, error corrections

# Table of contents

	<b>Preface .....</b>	<b>3</b>
<b>1</b>	<b>Panel Drivers and Tools software .....</b>	<b>7</b>
1.1	Product description .....	7
1.2	System requirements .....	7
1.3	Setup .....	9
1.3.1	Initial startup .....	9
1.3.2	Display size and support information .....	14
1.3.3	Removal .....	15
<b>2</b>	<b>IPC Configuration Center .....</b>	<b>17</b>
2.1	Product description .....	17
2.2	Overview and tabs .....	17
<b>3</b>	<b>Software description.....</b>	<b>23</b>
3.1	General information .....	23
3.2	Brightness - SetBrightness .....	23
3.2.1	Overview .....	23
3.2.2	Setting the display brightness .....	23
3.2.3	Command line call .....	25
3.3	Information .....	26
3.4	IFP ETH - Ethernet Monitor .....	27
3.4.1	Connection options (overview) .....	27
3.4.2	Connecting multiple Ethernet monitors (default IP address range) .....	28
3.4.3	Operation of multiple Ethernet monitors in a non-default IP address range .....	29
3.5	Screen saver - IPCScreenSaver .....	31
3.6	Tools - Rightclick and WinMove .....	33
3.6.1	Overview .....	33
3.6.2	Rightclick Selector .....	34
3.6.3	WinMove .....	34
3.7	Universal Pointing Device Driver (UPDD).....	35
3.7.1	Overview UPDD Console .....	35
3.7.2	Notes on clone mode .....	37
3.7.3	Calibrate touch screen .....	37
3.7.3.1	Standard calibration .....	38
3.7.3.2	Extended calibration .....	39
3.7.4	Touch functionality .....	40
3.7.4.1	Deactivate touch functionality .....	40
3.7.4.2	Extended Touch touch functionality .....	41
3.7.4.3	Touch in Extended Monitor mode .....	41
<b>A</b>	<b>Technical support.....</b>	<b>45</b>
A.1	Service and support .....	45
A.2	Troubleshooting .....	45
A.3	Touch input locked by EMTouchSync.exe .....	47



# Panel Drivers and Tools software

## 1.1 Product description

The SIMATIC IPC PDT software installs the "IPC Configuration Center" and the "IFP Ethernet Monitor" software. The existing hardware components are automatically detected by the associated software.

The most important features of the software are:

- Easy dialog-guided installation
- Simple configuration via the IPC Configuration Center:
  - Brightness
  - Information
  - Screen saver
  - Tools
  - Touch settings
  - ETH settings

## 1.2 System requirements

### Supported operating systems

The PDT software can run on PCs with the following operating systems:

- Microsoft Windows 32-bit operating system \*
  - Windows 7 Ultimate SP1
  - Windows Embedded Standard 7P/E SP1 \*\*
- Microsoft Windows 64-bit operating system \*
  - Windows 7 Ultimate SP1
  - Windows Embedded Standard 7P/E SP1 \*\*

\* Windows 10 is not supported.

\*\* 3 GB free hard disk memory required.

NOTICE
<b>Windows Embedded Standard 7 on CFast card</b>
For systems with Windows Embedded Standard 7 on a CFast card, the data is compressed and must be unzipped for the installation. The installation of the PDT software can take up to 40 minutes.

### Software requirements

- One of the operating systems listed in the section "Supported operating systems" was installed.
- The driver of the device manufacturer for the graphics adapter is installed.
- Installed SIMATIC software must be uninstalled:
  - IPC Ethernet Monitor V1.x  
Read the information in section "Removal".
  - IPC PDT V1.x
  - IPC Wizard V1.x to 2.x.x

### Hardware requirements

For the PDT software, you need a PC with the following properties:

- DVD drive or external USB data carrier
- Display port or DVI interface
- 1 GHz processor or higher, 32-bit (x86) or 64-bit (x64)
- 2 GB RAM
- 3 GB free hard disk memory
- Gigabit network components (cables, switches)
- Use graphics driver matching the graphics interface in use

---

#### Note

##### Initial commissioning

The IFP must be connected to the PC during initial commissioning.

##### Number of IFPs on a PC

The number of monitors which can be connected to a PC depends on the system configuration and operating mode. You can find the possible combinations in the FAQ 109483774 on the Internet (<https://support.industry.siemens.com/cs/us/en/view/109483774>).

##### Mixed operation not allowed

The simultaneous operation of the following device combinations in connection with a PC is not allowed:

- Devices with resistive single-touch screen and devices with capacitive multi-touch screen
  - Device with display diagonal 4:3 and devices with display diagonal 16:9
-



---

## Important notes on Ethernet monitors

---

### Note

#### Different orientations of Ethernet monitors

Operate all connected Ethernet monitors either in portrait format or landscape format.

Only use the following methods to change the display format:

- Change one monitor under Windows with "Display > Screen resolution > Orientation"
  - Change all monitors in the Configuration Center, "Touch settings" menu
- 

### Note

#### No energy-saving mode for the Ethernet Monitor

The energy-saving mode of the Windows operating system, sleep mode and standby are not supported by the Ethernet Monitor software and "IPCScreenSaver".

---

### Note

#### PC and Ethernet monitors must be in the same subnet

The PC and the connected Ethernet monitors must be operated in a closed network segment. Otherwise, an excessively high network load due to third-party devices will impair reliable communication in the network.

---

## 1.3 Setup

### 1.3.1 Initial startup

As standard, you connect only **one** single Ethernet monitor to the PC, for example, IFP Ethernet Monitor.

If you connect **multiple** Ethernet monitors to the PC, one monitor must always be connected **directly** via the following cables (see the overview graphic in section "IFP ETH - Ethernet Monitor (Page 27)"):

- IFP Ethernet Monitor via DisplayPort and USB cables
- Industrial Flat Panel via DisplayPort, DVI and USB cables
- With Panel PC, the internal screen is already connected directly.

This section describes the commissioning of the directly connected monitor as first or only monitor (initial commissioning). The connection of additional monitors is described in the section "Connecting multiple Ethernet monitors (default IP address range) (Page 28)".

You must uninstall any PDT software installed on SIMATIC IPC. Then install the PDT ETH software that is supplied on the "Documentation and Drivers" CD/DVD (included in the scope of delivery of SIMATIC devices or orderable). The PDT ETH software automatically installs the Configuration Center and the corresponding software component for the connected device type.

## Requirement

- The system requirements (Page 7) are met.
- Keyboard and mouse are connected to the PC.
- The Ethernet Monitor is in the delivery state ex factory or has been reset to factory settings.
- If you connect only **one** single Ethernet monitor, it is connected via DisplayPort, USB and LAN cables with the PC for commissioning.
- If you connect **multiple** Ethernet monitors, one of these is continuously connected directly via DisplayPort and USB cables with the PC.

---

### Note

The Ethernet driver is not yet active during the installation. As a result, the Ethernet monitor only displays a screen via the DisplayPort interface.

If the PC has no DisplayPort interface you cannot track the commissioning on the Ethernet monitor. In this case, connect an external monitor to the PC.

---

---

### Note

#### Administrator rights without administrator password

Installation must be performed with a user account that has administrator rights but **no** logon password.

- If it does not exist, create an account with administrator rights for the operating system of the PC
  - If you have already assigned a logon password, delete it.
- 

## Procedure

1. Switch on the PC and Ethernet monitor
2. If the PC does not have an operating system, install an operating system with all the required components.
  - Install Windows from the appropriate data storage medium.
  - If you run the installation from the Restore DVD: Restart the PC once installation is complete.
3. Start the computer.

A screen is displayed in the "Screen resolution" Desktop menu.

The monitor connected via the DisplayPort is displayed under "Monitors" (default) in the device manager.
4. If a setup of the SIMATIC IPC Wizard or SIMATIC IPC Panel Drivers and Tools is already installed on the PC:
  - Uninstall this setup via the Control Panel.
  - Restart the computer.

5. If the PC does not have a DVD drive, copy the entire directory of the PDT software including subdirectories from the "Documentation and Drivers" CD/DVD to a USB flash drive.
6. Place the "Documentation and Drivers" CD/DVD into the DVD drive of the PC. Alternatively, connect the USB memory stick to the PC.
7. Start the installation of the PDT ETH software via "Start.exe".
8. The installation dialog opens: The installation steps on the left are completed from top to bottom.  
First accept the license conditions and click "Next".
9. The required software components are displayed as check in the "Configuration" tab, depending on the device type. Click "Next".

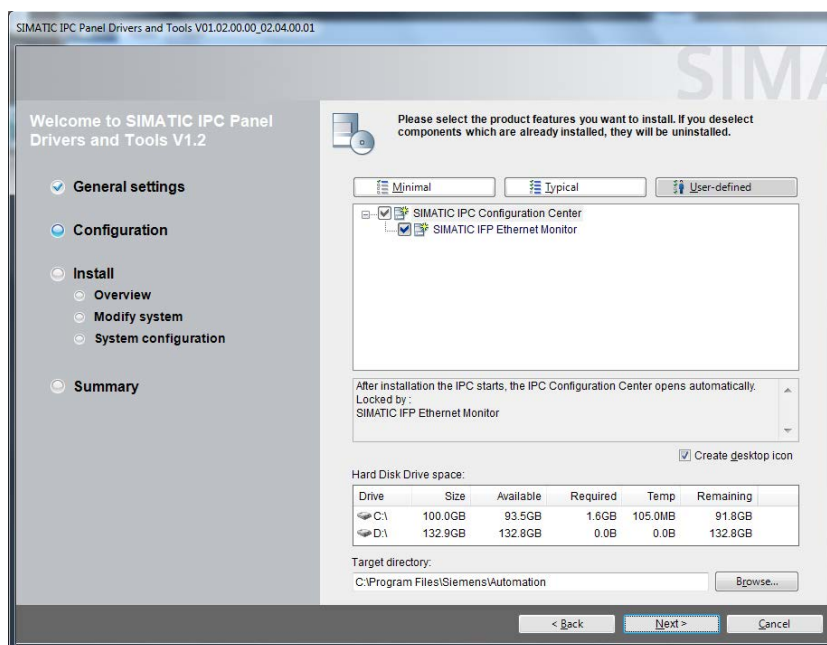

10. Follow the instructions. The setup installs the associated software.  
This process may take anywhere up to thirty minutes.  
The Ethernet driver is installed.
  - Two screens are now displayed in the "Screen resolution" Desktop menu.
  - The monitor connected via USB is displayed in the device manager under "USB and network display devices > SMSC UFX6000".
11. If you connect **multiple** Ethernet monitors to the PC, the following applies:  
If the first connected monitor is an IFP Ethernet monitor, disable (**do not** uninstall) the device in the device manager "SMSC UFX6000" and restart the PC. Secondary effect for checking: The screen contents are already displayed on the monitor during startup.



12. Start the IPC Configuration Center ICC using the associated Desktop icon.

Alternatively, select "Start > All Programs > Siemens Automation > IPC Configuration Center > IPC Configuration Center".

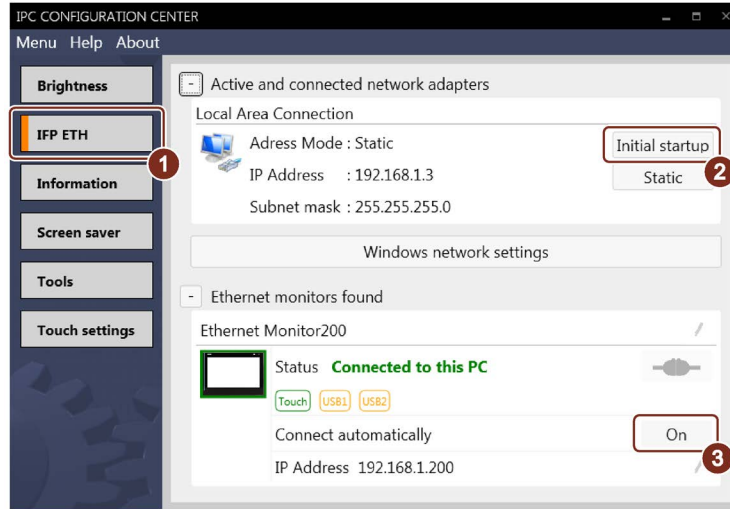

The figure shows an example of a connected Ethernet monitor after commissioning is complete.

13. Select the tab ① "IFP ETH" and press the button ② "Initial startup".

You will see an error message if you do not have administrator privileges. Exit the error message with "OK". The administrator privileges are assigned. Click the button ② "Initial startup" again.

Initial startup begins and may last several minutes.

Among other things, the IP addresses of the devices are changed as follows during commissioning:

- On the PC: Change the IP address to "192.168.1.3". A search is then started in the LAN network in this IP address band.

---

### Note

#### No inputs during automatic commissioning

When an Ethernet Monitor with factory settings is connected for the first time to the PC via LAN, automatic commissioning is started and may take up to 5 minutes. The driver software is installed in the background.

Do not operate the Ethernet Monitor during this time. Do not install any other software during this time.

- On the Ethernet Monitor found: Change IP address from factory setting "192.168.1.2" to "192.168.1.200"

Commissioning is complete when the respective Monitor displays "Connect automatically" ③ "On".

14. When the following **LAN connection message** appears, click "Shutdown". Wait until the PC has been shut down.

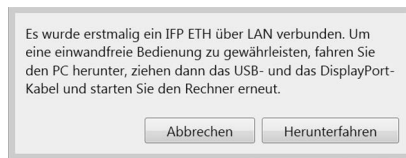

15. If you connect only **one** single Ethernet monitor to the PC, you can now remove the DisplayPort and USB cables. The Ethernet Monitor is now connected to the PC only via the LAN cable. For PC with Intel Skylake CPU: Continue in the section "Additional procedure for PC with Intel Skylake CPU with only one Ethernet monitor", and then with the following step.

If you connect **multiple** Ethernet monitors, the DisplayPort and USB cables of the first monitor remain plugged.

16. Assign a logon password for the user account with administrator rights (see "Requirements" section).

17. Restart the PC and log on to the user account with administrator rights.

The Ethernet Monitor now connects to the PC automatically in about 30 seconds. The monitor screen remains dark during this time.

Once the connection has been successfully established, the Monitor displays an image and you can operate its touch screen.

To also connect additional Ethernet monitors in addition to the directly connect monitor, simply connect other Ethernet monitor one after the other via LAN cable with a switch which is in turn connected to the PC (see section "Connecting multiple Ethernet monitors (default IP address range) (Page 28)").

### Additional procedure for a PC with Intel Skylake CPU with only one Ethernet Monitor"

PCs with Intel Skylake<sup>1</sup> CPU, such as SIMATIC IPC427E or IPC547G require an additional commissioning of the Ethernet Monitor. Reason: If the DisplayPort cable is disconnected from the PC at the conclusion of commissioning, these PCs create their own virtual main screen and the Windows login window is then not visible. For the Windows logon window to be visible on the Ethernet monitor during initial logon, set up the Ethernet monitor as main screen:

1. Restart the computer.

The restart can take a few minutes. After the restart, the extended desktop is displayed on the Ethernet monitor.

2. Right-click on the desktop (shortcut keys: <Shift+F10>) and select "Screen resolution". The dialog to change the appearance on the screens appears.

---

#### Note

If the dialog for changing the screen display is not shown on the Ethernet monitor, re-select "Screen resolution" from the short-cut menu of the desktop and then press the shortcut keys "Shift+Windows key + arrow right". These shortcut keys move the active window to the extended desktop of the Ethernet monitor.

---

### 1.3 Setup

3. Under "Display", select the monitor with the designation "IFPxx00 ETH" (xx = Display diagonal in inches) and select the "Make this my main display" option.
4. Confirm with "OK".

The contents of the main screen are displayed on the monitor. Since the Ethernet driver is only active after the Windows start, the screen content is only displayed after the PC has powered up.

<sup>1</sup> Skylake is the Intel's internal name for a series of processors. Search on the internet for the name of your PC's CPU. If it is an Intel Skylake CPU, some manufacturer websites, such as Intel.com show the assignment to this processor series.

## 1.3.2 Display size and support information

### PPI settings for new users

---

#### Note

#### Size of the operator controls

The operator controls of Windows applications have a different size depending on the different screen sizes. By adjusting the display size for characters and objects (PPI resolution) you set the operator controls to an operable size. Only for the standard user, however, and not for other users.

- To set the PPI resolution for a different user, log on as new user with your own Account and click Set SIMATIC IPC Windows PPI Settings in the Windows Start menu "Start > Siemens Automation".

Restart the computer to apply the values for the desktop.

- **Uninstall:** To remove the adjusted PPI resolution for the desktop, click "Set default Windows PPI Settings" in the Windows Start menu "Start > Siemens Automation".

Restart the computer to apply the values for the desktop.

---

### Support information

The link "IPC\_Service&Support" on the desktop provides a brief summary of the PC hardware information. This HTML page is created at the time of installation and can be called later in the browser.

Call the diagnostics for the support via the link in the bottom-left:

- IPCLogFileSaver opens.
- Only general information about the customer device and device information for fault analysis are transferred.
- No customer data is read out.

PC Hardware Information (V1.3)	
IPC Configuration Center (V3.4.0)	
PC Model:	SIEMENS AG SIMATIC IPC477E
Windows-Edition:	Windows Embedded Standard 64 Bit Build 7601
DotNet Framework Version V4:	4.5.51209
Bios Info:	SIEMENS AG V21.01.03 Release Date: 09/07/2016
CPU Typ :	Intel(R) Xeon(R) CPU E3-1505L v5 @ 2.00GHz
Physical Memory in GB (usable)	7.9
Free Space C: in GB:	89
Volume Size C: in GB:	100
Device Type:	SIEMENS IPC capacitive Multitouch
Device label: SIEMENS Touch Monitor	IPC477_22T
<a href="#">Service &amp; Support</a>	
<a href="#">Support &amp; Download</a>	
<a href="#">Readme</a>	
<a href="#">Starting to diagnose with IPCLogFileSaver.exe</a>	
Copyright © Siemens AG 2017. All rights reserved.	

### 1.3.3 Removal

#### Requirement

- The SIMATIC TDT software is installed.
- An external monitor is connected to the DisplayPort or DVI interface of the PC. Otherwise the uninstall process cannot be completed because the connection to the Ethernet monitor is interrupted during the process.

---

#### Note

##### Administrator rights are required

The software must be uninstalled with a user account with administrator rights.

---

## Procedure

1. Disconnect from the PC all LAN **and** USB cables with which Ethernet monitors are connected. Otherwise the PDT ETH software will not be fully uninstalled from the PC.
2. If you have activated the "Right-click Selector" or Winmove" tools, disable these tools.
3. Uninstall the SIMATIC PDT ETH software.
4. Restart the PC and log into the user account with administrator rights.

<b>NOTICE</b>
<b>Flickering</b> The graphics driver is reactivated during uninstallation. Flickering that results in incorrect operation can damage the machine or plant. If the components "SMSC Core Graphics Software" and "ViewSpan" are still installed, remove them manually using the Control Panel.



# IPC Configuration Center

## 2.1 Product description

Along with the PDT software, various software components are installed on your PC depending on the device features, allowing you to configure the SIMATIC IPC or connected SIMATIC Industrial Flat Panel. The IPC Configuration Center provides a convenient interface for operating these software components.

You can use the Configuration Center to configure your device directly or open the respective setting dialogs of the operating system.

## 2.2 Overview and tabs

### Requirement

- A corresponding software component is installed for each SIMATIC device type on the PC (see initial commissioning):
  - for SIMATIC Monitor Standard: SIMATIC IFP Monitor software
  - for SIMATIC IPC/IFP with resistive single-touch screen: SIMATIC Single-touch software
  - for SIMATIC IPC/IFP with capacitive multi-touch screen: SIMATIC Multi-touch software
  - for SIMATIC IPC/IFP Touch/Key with resistive single-touch screen: SIMATIC PhoneKeyPad software
  - for SIMATIC IFP ETH with resistive single-touch screen or capacitive multi-touch screen: SIMATIC Ethernet Monitor software
- The system requirements (Page 7) are met.

---

### Note

#### Windows Fast User Switch

Only one instance of the Configuration Center can be open at a given time. This is why "Windows Fast User Switch" for switching between multiple simultaneously logged on users is not supported.

1. Close the Configuration Center.
  2. Open the Configuration Center as a different user.
-

**Note**

**Device detection**

If you connect another device of the same SIMATIC device type during operation, for example, a second device with resistive single-touch screen or if a device is not recognized, close the Configuration Center and open it again. The additional devices will then be detected. Alternatively, refresh the Configuration Center using the menu.

If you connect a SIMATIC device type (see above) for which no corresponding software component has been installed on the PC yet, the device is not recognized. You must install the missing software component as follows:

1. Remove the connection of the device type from the PC.
2. Uninstall the Panel Drivers and Tools software.
3. Connect the device type with the PC.
4. Install the Panel Drivers and Tools software again.

The missing software component is installed and the SIMATIC device type is recognized afterward.

If a SIMATIC device type is still not recognized, check the connecting cables and the device version.

---

**Opening the Configuration Center**



- Start the IPC Configuration Center ICC using the associated Desktop icon or - if enabled - using the icon in the information area of the taskbar (see section "Configuration Center Settings").

Alternatively, select "Start > All Programs > Siemens Automation > IPC Configuration Center > IPC Configuration Center".

The Configuration Center starts and retrieves the data of the connected devices. This process may take several minutes.

**Closing the Configuration Center**

You close the Configuration Center in the menu bar via "Menu > Exit".

Alternatively, close the Configuration Center - if enabled - using the icon in the information area of the taskbar: Select the menu item "Exit" in the shortcut menu of the "ICC" icon.

You conserve system resources by closing the Configuration Center. The functions of the Configuration Center are still being executed, e.g. screen saver, right-click, etc.

**Refreshing the Configuration Center**

You refresh the Configuration Center in the menu bar via "Menu > Refresh". The Configuration Center updates the information on the connected IFPs.

**Operating the Configuration Center**

Change a setting directly on the interface. All settings are immediately applied and permanently stored.

Depending on the device features, one or more software components on the device are shown in summary in several tabs at the left. The following figure shows an example.

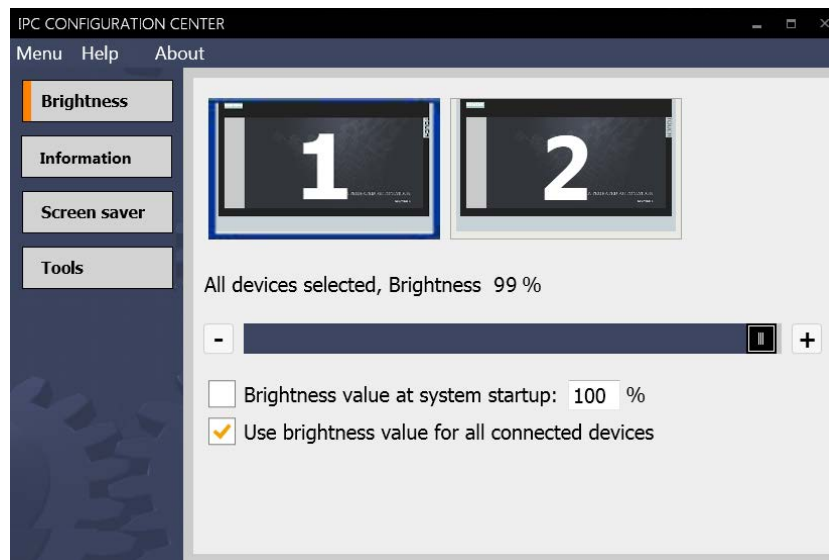

- "Brightness" tab: individual adjustment of the brightness of all connected devices.
- "Information" tab displays basic information about the device.
- "Screen Saver" tab: activates and configures the "IPCScreenSaver" screen saver.
- The "Tools" tab includes the following additional functions:
  - Triggering a right-click.
  - Moving the screen content on devices with a vertical resolution of  $\leq 600$  pixels. This gives you access to operator controls that are located outside the screen.

## Configuration Center Settings

You configure the Configuration Center in the dialog "Settings", which you open in the menu bar via "Menu > Settings".

Alternatively, open the "Settings" dialog - if enabled - using the icon in the information area of the task bar: Select the "Settings" menu item in the shortcut menu of the "ICC" icon.

The following options are available:

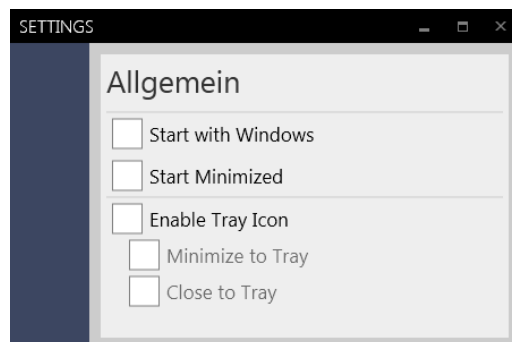

- "Start with Windows": The Configuration Center is also started with the operating system (Autostart).
- "Start minimized": When the Configuration Center is started, it is minimized in the task bar.
- "Enable Tray Icon": The "ICC" icon (Tray Icon) appears in the information area.

The following options are available when the "ICC" is enabled:

- "Minimize to Tray": If you press the "Minimize window" Windows icon in the Configuration Center, it does not appear minimized in the taskbar, but as "ICC" icon in the information area.
- "Close to Tray": If you press the "Close window" Windows icon in the Configuration Center, it is not closed, but appears as "ICC" icon in the information area. To close the Configuration Center, proceed as in the "Close Configuration Center" section.
- "IFP ETH" tab:

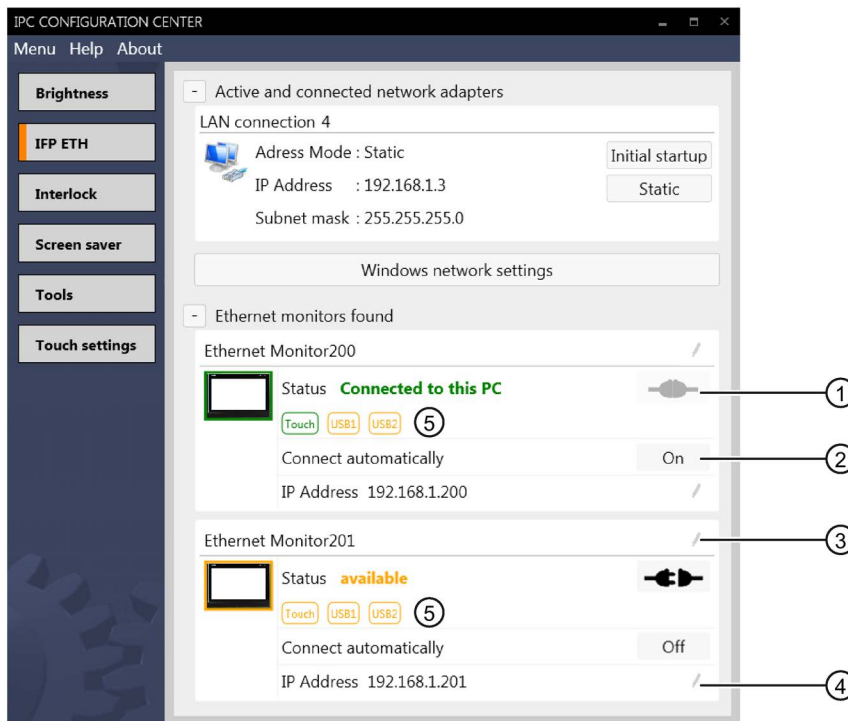

- ① "Connection" button
- ② "Connect automatically" button
- ③ "Edit" key: Name of the Ethernet Monitor
- ④ "Edit" key: IP address
- ⑤ Status indicators:
 

<ul style="list-style-type: none"> <li>• Touch</li> <li>• Orange: Touch connection to PC is inactive</li> <li>• Green: Touch connection to PC is active</li> </ul>	<ul style="list-style-type: none"> <li>• USB</li> <li>• Orange: USB Port is not assigned</li> <li>• Green: USB port is assigned, e.g. with USB stick</li> </ul>
--	---

- "Active and connected network adapters": Shows the network settings, for example, IP address of the PC network adapter to which the LAN cable is connected.
- "Initial startup": assigns the IP address of the PC network adapter, see section "Initial startup (Page 9)".
- "Static": You assign the IP address of the PC manually, see section "Operation of multiple Ethernet monitors in a non-default IP address range (Page 29)".
- "Windows network settings": Opens the Windows standard dialog: You establish the connection of the PC to a network with the operating system and change the connection parameters.
- "Ethernet monitors found in the same subnet": List of Ethernet monitors found in the LAN network to which the PC is connected.
- "Status": Status of the LAN connection of the found Ethernet monitor:
  - "Connected to this PC": Connected to the PC only via LAN (operating mode). The "Connection" icon is grayed out because the LAN connection cannot be closed.
  - "available": Ethernet monitors detected in the network which do not have an active connection to a PC or are only connected to the PC via USB, DisplayPort and LAN cable (setup mode). When you press the "Connection" icon, the LAN connection is closed immediately to change the IP address.
- "Connect automatically": "On": The LAN connection is reestablished automatically after a PC restart. "Off": The LAN connection is closed even after a restart. The Ethernet Monitor remains dark.

---

**Note****Update of the network topology**

When you are making changes in the LAN network, wait about 5 minutes for the network topology to update.

---

- Tab "UPDD Settings": Universal Pointing Device Driver (UPDD): Touch settings:
  - "Check calibration": Opens a test screen with buttons without function. Touch the screen and try to activate the individual buttons. This helps to recognize the quality of the screen calibration.
  - "Calibration": Immediately starts the 3-point calibration of the UPDD; see section "Standard calibration (Page 38)".
  - "Settings": Opens the UPDD configuration menu (Page 35) with a variety of device settings, for example, Extended calibration (Page 39), Touch functionality (Page 40) or the interlock mechanism in clone mode.
  - Assigning several connected displays with "Touch in Extended Monitor mode (Page 41)" using "Tablet PC settings".



## Software description

### 3.1 General information

---

**Note****Full device detection**

If you connect or remove an IFP while the Configuration Center is open, this change is not immediately detected by the Configuration Center. Only when an IFP has been fully detected can you make settings for this IFP in the Configuration Center. For full detection or update of the devices in the Configuration Center, select "Menu > Refresh" or restart the Configuration Center.

---

### 3.2 Brightness - SetBrightness

#### 3.2.1 Overview

Adjusts the display brightness for all connected and detected devices. If the PC used is a Panel PC, then the display brightness of the Panel PC is adjusted.

#### 3.2.2 Setting the display brightness

#### Procedure

---

**Note****Deviating numbering**

Depending on the graphics chip and operating system, the sequential numbering of the devices may deviate from the numbering in Windows:

---

1. Open the Configuration Center and go to the "Brightness" tab.
2. Select the device whose brightness display you want to change. The following example shows two device displays. In the example, device "1" is selected, all other devices are not selected. If no device is selected, the display brightness of all devices is changed to the same degree.

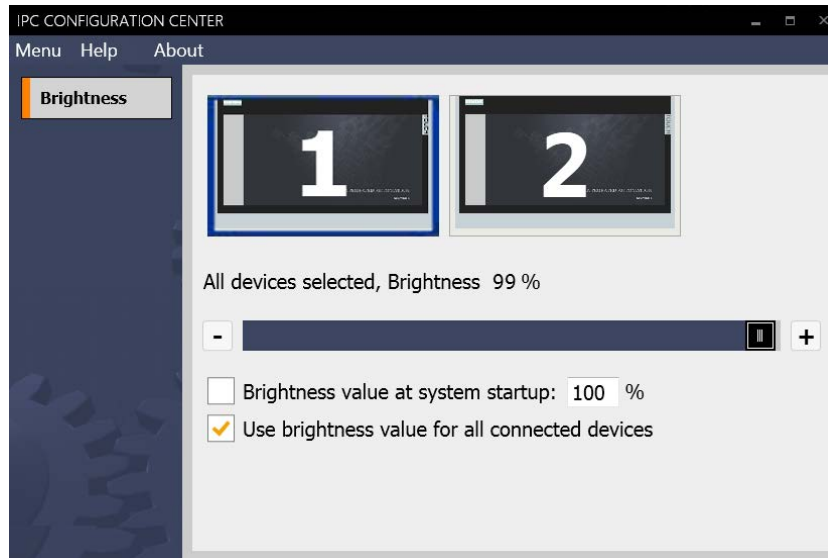

3. Set the desired display brightness. You have the following setting options:
  - Using the slider. The set value is applied when you release the slider.
  - Using the "Increase brightness (+)" and "Decrease brightness (-)" buttons.

---

**Note**

The minimum value for the brightness setting is 10%. If you select a value of less than 10% using one of the setting options, the brightness value is automatically set to 10%.

4. To set a fixed brightness value for all devices at every system startup, except for hibernation (standby), select "Brightness value at system startup".  
Enter the desired brightness in percent in the box on right. The setting is valid only for the current user and first takes effect upon logon.  
If you disable "Brightness value at system startup", the brightness value set in step 3 takes effect.
5. If necessary, enable "Use brightness value for all connected devices". Alternatively, click in the empty box next to the device icons. Then the brightness is the same again for all devices.

**Buttons in the preview window**

If the Configuration Center is started and appears as an icon in the taskbar, you can also change the brightness using the small buttons above the icon in the preview window.



### 3.2.3 Command line call

#### Call parameters

A parameter can be specified for the command line call of the "SetBrightness" program.

---

#### Note

By pressing an input device, for example, a touch screen or keyboard, the display is switched on again with 100% brightness value. The first input event, for example, a mouse click, is discarded in this case to avoid an unintentional incorrect operation.

---

#### [VALUE] parameter

Value	Explanation
1 to 100	Brightness in percent

Example of command line call: `setbrightness.exe 50` sets the brightness to 50%.

#### Suppression of batch process window

With a command line call, a black Windows output window of the batch process is displayed briefly.

To suppress the Windows output window, start the "SetBrightness.exe program via the following example source code in C# syntax:

```
var process = new Process
{
    StartInfo = new ProcessStartInfo
    {
        FileName = "SetBrightness.exe",
        Arguments = "[number]", // [number] Value (0 -100)
        WindowStyle = ProcessWindowStyle.Hidden
    }
};
process.Start();
```

### 3.3 Information

#### Introduction

The "Information" tab shows the device configuration and connected components of SIMATIC IPC/IFP whose data is currently being read out by the device. Information about the device and the connected network connections can also be displayed.

**Note**

**Different information**

Different information can be displayed depending on the connected hardware. The software automatically detects the connected hardware. If components such as network adapters are changed, the Configuration Center must be refreshed (see "IPC Configuration Center" section).

IPCLogFileSaver provides detailed information on the current device data, see "Display size and support information (Page 14)", "Support information" section.

#### Displayed information

The following information is read out:

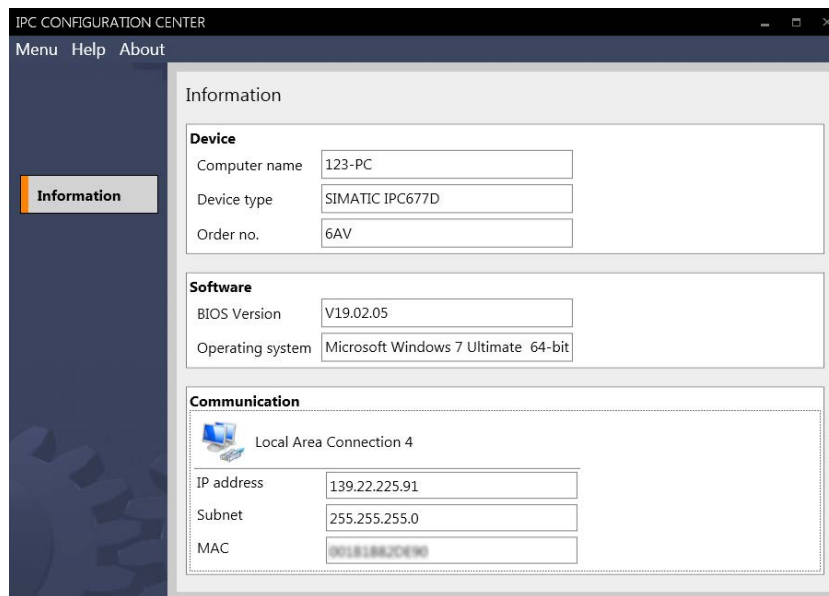

Area	Information
Device	Basic information on the device: <ul style="list-style-type: none"> <li>• Device name</li> <li>• Device type</li> <li>• Order number</li> </ul>
Software	Information on software components: <ul style="list-style-type: none"> <li>• BIOS version</li> <li>• Operating system</li> </ul>
Communication	For each connected network adapter, for example LAN: <ul style="list-style-type: none"> <li>• Adapter name</li> <li>• IP address</li> <li>• Subnet mask</li> <li>• MAC address</li> </ul>

## 3.4 IFP ETH - Ethernet Monitor

### 3.4.1 Connection options (overview)

In general, you can connect to the PC, e.g. SIMATIC IPC, the following Ethernet monitors:

- IFP Ethernet Monitor ① or
- Industrial Flat Panel ② or
- SIMATIC Panel PC ③ = PC with separate screen

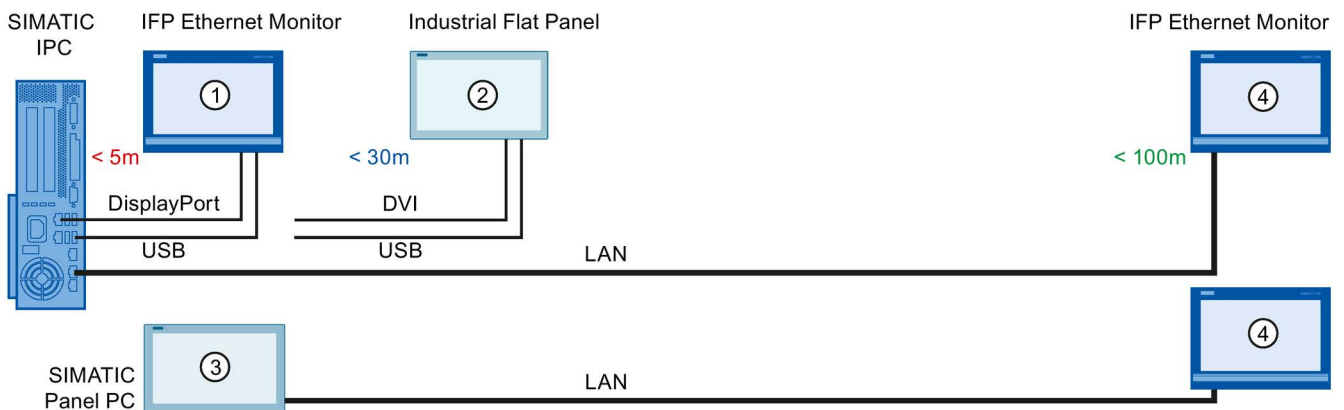

The figure shows the connection options on a PC, with distance to the PC increasing on the right (5, 30, 100 meters)

- Either you connect the PC to **one** single Ethernet Monitor: An LAN cable ④ allows cable lengths up to 100 meters.
  - Or you connect **multiple** Ethernet monitors to the PC. In this case one monitor must be **directly** connected:
    - IFP Ethernet Monitor ① via DisplayPort and USB cables. The DisplayPort cable has a maximum cable length of 5 m.
    - Or Industrial Flat Panel ② via DVI cable and USB cable. The DVI cable is connected to the IPC via a DisplayPort-to-DVI adapter (article number 6ES7648-3AF00-0XA0) and allows cable lengths up to 30 m.
    - Or a SIMATIC Panel PC ③, where the internal screen is already directly connected.
- You then connect other Ethernet monitors ④ via the LAN cable.

### 3.4.2 Connecting multiple Ethernet monitors (default IP address range)

#### Requirement

- A first Ethernet monitor is installed in the system, connected directly via DisplayPort/DVI and USB cables to the PC, and commissioned (see "Initial commissioning" section).
- All other Ethernet monitors are in the delivery state set at the factory or have been reset to factory settings.

The figure below shows a PC with three IFP Ethernet monitors: Monitor 1 is directly connected to the PC. Monitors 2 and 3 are connected to the PC via a LAN switch (recommendation):

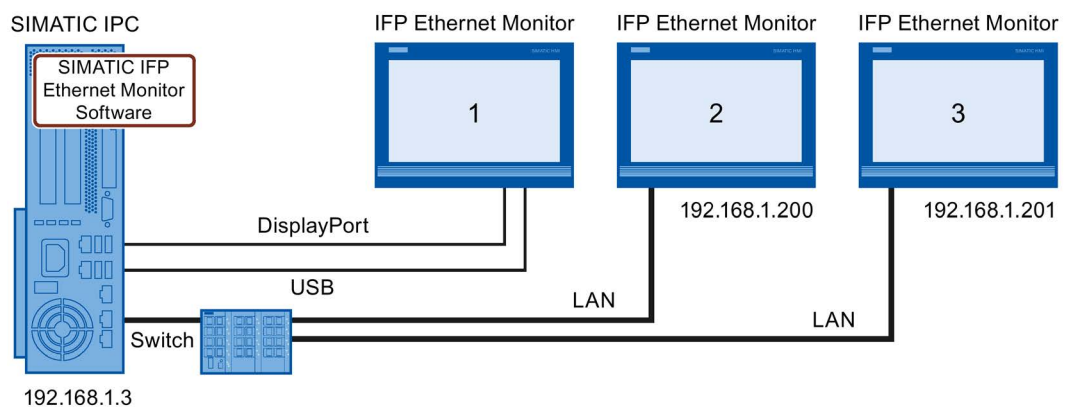

#### Procedure

##### NOTICE

##### Remote control of the Configuration Center

If you execute an operation while the connection is being established, this will lead to a malfunction.

- Do not make any input in the "IFP ETH" tab during this period.
- Wait until the Ethernet Monitor displays the Windows screen and appears in the "IFP ETH" tab under "Ethernet monitors found in the network".

1. Switch on all devices.
2. Wait until the connection has been established on the PC: The Windows screen appears and the Ethernet monitor is displayed in the "IFP ETH" tab in the Configuration Center.
3. Connect another Ethernet monitor to the PC via LAN. Commissioning starts up automatically. This can take up to 5 minutes per device.

Among other things, the IP addresses of the Ethernet monitors are changed from the factory setting "192.168.1.2" to "192.168.1.20x", x = 0, 1, ... changes continuously.

4. Wait until the connection has been established at the PC and the Windows screen appears.

5. When **LAN connection message** appears, click "Shutdown".  
Wait until the PC has been shut down.  
Do **not** remove the DisplayPort cable and USB cable of the first monitor.
6. Repeat steps 3 and 5 until all Ethernet monitors have been commissioned.
7. Close and open the Configuration Center. All tabs are updated.
8. In the "Brightness" tab, set the brightness of all connected devices individually.
9. Configure "Display on the screens" with "Windows Control Panel > Display > Screen resolution":
  - To distinguish the Ethernet monitors, click "Identify". A number appears on each screen.
  - In the "Multiple displays" box, specify whether the screens are to show the same content or are to be combined into a large display area.
  - To assign the physical monitors to the shown screen contents, proceed as described in the section "Touch in Extended Monitor mode (Page 41)" in the note "Assignment: Extended monitor mode with two or more screens".

The PC is connected to all Ethernet monitors via LAN in the default IP address band 192.168.1.xxx.

---

#### **Note**

##### **Assignment is lost**

If you connect an Ethernet Monitor as 2nd device and change the "Display on the screens" in step 9, for example, the "Orientation", you must repeat the assignment of the physical monitors in step 9.

If you connect a 3rd device, you can operate all monitors in either landscape format or portrait format. Mixed operation causes problems during assignment of the touch screens after a power failure or a restart.

---

### **3.4.3 Operation of multiple Ethernet monitors in a non-default IP address range**

#### **Requirement**

- The first Ethernet monitor is connected **directly** to the PC via the DisplayPort and USB cables (see figure) and commissioned (see "First commissioning" section).
- The default setting is the IP address range 192.168.1.xxx.
- All other Ethernet monitors are connected successively via LAN to the PC and commissioned (see previous section).

The figure below shows a PC with multiple Ethernet monitors that are to be located in a non-default IP address range 10.199.200.xxx:

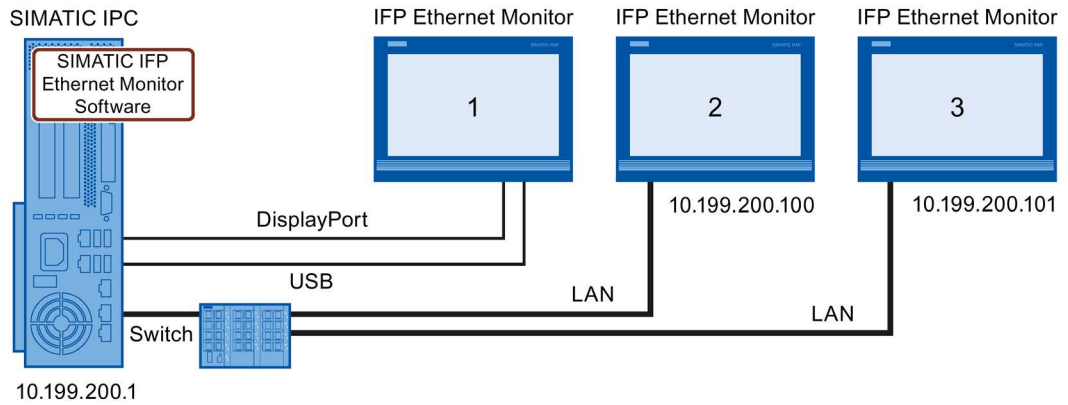

### Procedure

**NOTICE**

**Remote control of the Configuration Center**

If you execute an operation while the connection is being established, this will lead to a malfunction.

- Do not make any input in the "IFP ETH" tab during this period.
- Wait until the Ethernet Monitor displays the Windows screen and appears in the "IFP ETH" tab under "Ethernet monitors found in the network".

1. Switch on all devices.
2. Connect the keyboard and mouse to the PC.
3. Open the Configuration Center and go to the "IFP ETH" tab ①.

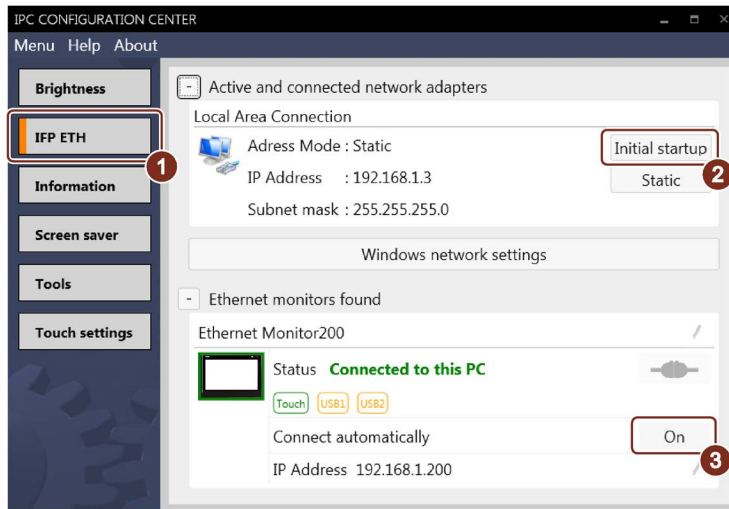

4. If "Ethernet Monitor found in network" click "On" once in the "Connect automatically" line. The display switches from "On" to "Off".

5. Press the "Connection" key above this until "available" is displayed.

Sometimes a prompt informing you that the LAN connection has been interrupted is hidden behind the active window. Briefly move this active window aside and confirm the prompt with "Ok".

If the Ethernet Monitor is not directly connected, its screen will be black when the LAN connection is disconnected. Follow the next steps on the first, directly connected monitor.

6. Use the upper "Edit" icon to change the name of the Ethernet monitor in the "Ethernet Monitor200" line.

Assign a unique name to differentiate the Ethernet monitors. This is important when you later need to replace or service them.

7. You assign a static IP address manually using the lower "Edit" icon ③: Change the IP address of the Ethernet monitor to 10.199.200.x, x = consecutive (see figure).

8. Repeat steps 4 - 7 for all connected Ethernet monitors.

9. Under "Active and connected network adapters", press the ② "Static" key and assign a static IP address 10.199.200.1 for the PC (see figure).

10. For all "Ethernet monitors found in network": If "Ethernet Monitor found in network" click "Off" once in the "Connect automatically" line until "On" is displayed again.

The Ethernet Monitor is searched for in the new network, found, and again connected to the PC. Once the connection has been successfully established, the "Connected to this PC" status is displayed.

The PC is connected to all Ethernet monitors via LAN in the IP address band 10.199.200.xxx.

## 3.5 Screen saver - IPCScreenSaver

### Introduction

The SIMATIC screen saver "IPCScreenSaver" is a standalone software component that is installed via the PDT software. You can configure the screen saver in the Configuration Center, from which you also open the Windows standard dialog "Screen Saver Settings".

The "IPCScreenSaver" switches on after a configured time, e.g. 1 minute. Then the brightness of all connected devices is set to the configured value, e.g. 23%. In contrast to most conventional screen savers, the "IPCScreenSaver" can save energy: The power consumption of screens set to dark is less than screens with high or normal brightness.

#### NOTICE

##### Using an IPCScreenSaver as the only screen saver

If a Windows standard screen saver is active during operation and the user touches the touch screen to deactivate it, then the display and the touch screen are activated again immediately. Touch operation is immediately evaluated, which can initiate unintended functions in the plant. With "IPCScreenSaver", the first touch of the touch screen is not evaluated and the screen content is displayed again. This means that the first touch to deactivate the screen saver does not initiate any unintended functions.

For this reason, use only "IPCScreenSaver" and set the "Turn off the display" option to "Never" under "Start > Control Panel > Power Plan Settings > Choose when to turn off the display".

### Procedure

1. Open the Configuration Center and go to the "Screen Saver" tab.

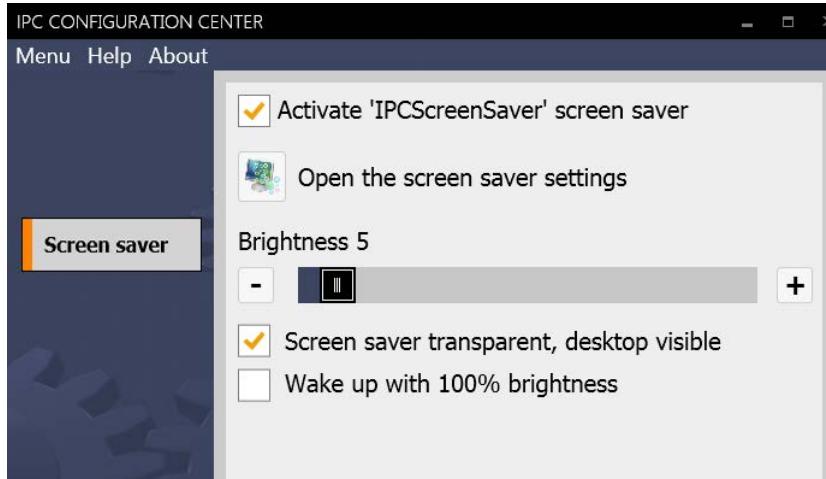

2. Select "Activate 'IPCScreenSaver' screen saver".
3. Set the desired "Brightness" for all the connected devices during the activity of the screen saver using the slider or the "-" and "+" buttons.  
Does not apply to IFP Ethernet monitors: If you set the value "0%" as the "Brightness", the backlighting of the display is disabled.
4. Does not apply to Windows 10: With the "Screen saver transparent, desktop visible" option, the window is transparent and a static screen of the desktop is visible.
5. If needed, select "Wake up with 100% brightness". After the screen saver is switched off, the screens of all connected devices are operated with 100% brightness.
6. Open the "Screen Saver Settings".

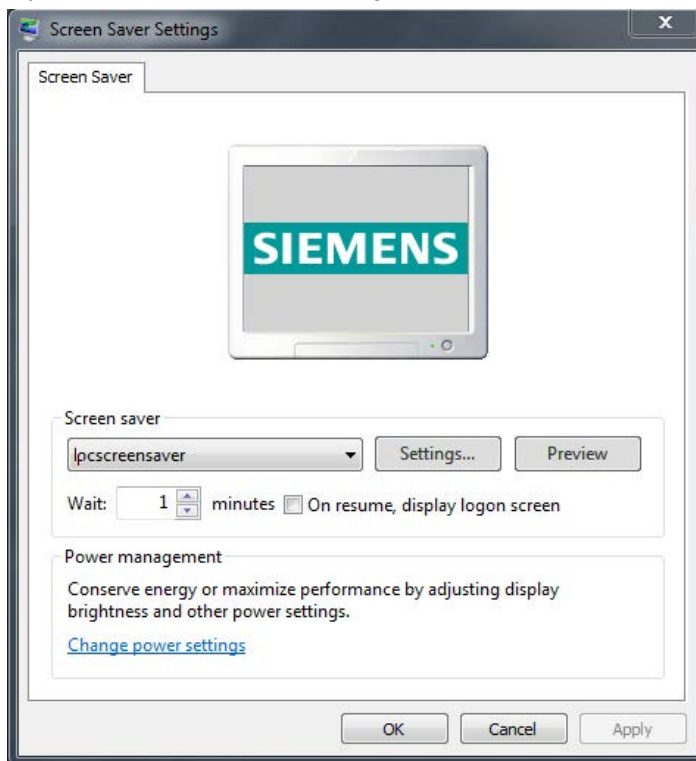



The screen saver "Ipcscreensaver" is activated.

#### Note

"Ipcscreensaver" is automatically activated, as the option "Activate 'IPCScreenSaver' screen saver" was activated in the Configuration Center, see step 2. If you select a different screen saver than "Ipcscreensaver" in the "Screen Saver Settings" dialog, then the "Activate 'IPCScreenSaver' screen saver" option is automatically deactivated in the Configuration Center.

7. Change the waiting time until a screen saver switches on to the required value.
8. Make additional settings as needed. Close all open dialogs and save the settings with "OK".

## 3.6 Tools - Rightclick and WinMove

### 3.6.1 Overview

In the "Tools" tab you can activate or deactivate the programs "WinMove" and "Rightclick Selector".

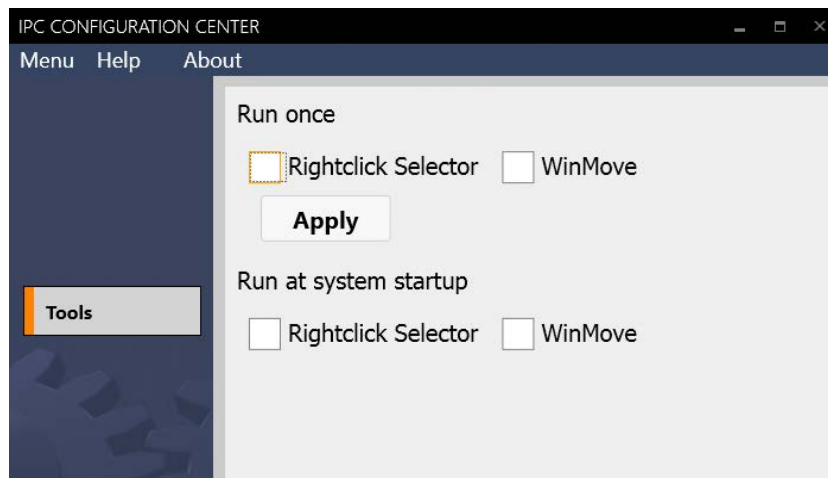

Distinguish between the following cases:

- "Run once" activates the respective program for the ongoing session.
- "Autostart" activates the respective program every time you start the PC on which the Configuration Center is installed.

You activate the changed settings with the "Apply" button and the corresponding program icons are displayed:

"Rightclick Selector" icon



"WinMove" icon



The following subsections describe the functions of the programs.

### 3.6.2 Rightclick Selector

When you press the "Rightclick Selector" icon, the next mouse click or the next touch of the touch screen is executed as a right-click.



---

#### Note

##### Right-click Selector

The right-click selector always relates to the screen on which the icon is visible. If two monitors are connected, first move the "Right-click Selector" symbol to the required screen before pressing the symbol. After the restart of the device, the "Right-click Selector" must be moved again to the required screen.

##### Delay time

There is no delay time in single-touch mode: The right-click function is executed immediately.

If the touch is used as multi-touch, the right-click function is executed with a specific delay. In Windows 7 you can set the delay time with a slider, but you cannot reduce it to zero.

For a multi-touch, Windows must be able to distinguish whether it is evaluating an operation or a right-click that causes the delay time.

---

### 3.6.3 WinMove

"WinMove" allows you to move program windows vertically in order to display window areas that extend beyond the display area. "WinMove" is mainly used on devices with a vertical resolution of  $\leq 600$  pixels.

#### Procedure

1. Open "WinMove" using the Configuration Center.

The "WinMove" window with the "Up" and "Down" buttons are displayed.



2. Move the open program window using the "Up" and "Down" buttons.

## 3.7 Universal Pointing Device Driver (UPDD)

### 3.7.1 Overview UPDD Console

The Universal Pointing Device Driver (UPDD) offers the following functions for single-touch operator panels:

- Configure clone mode with several operator panels, including touch interlock
- Configure extended mouse functions
- Configure properties for operating the touch screen
- Calibrate the touch screen and check the calibration
- Display the status of the operator panel

This chapter describes the following typical applications:

- Calibrate touch screen (Page 37)
- Deactivate touch functionality (Page 40)
- Activated extended touch functions (Page 41)
- Touch in Extended Monitor Mode (Page 41)

For the meaning of all UPDD parameters, refer to the Online Help.

#### UPDD Console

The UPDD Console is used to configure the UPDD driver:

1. Open the Configuration Center and go to the "UPDD Settings" tab.

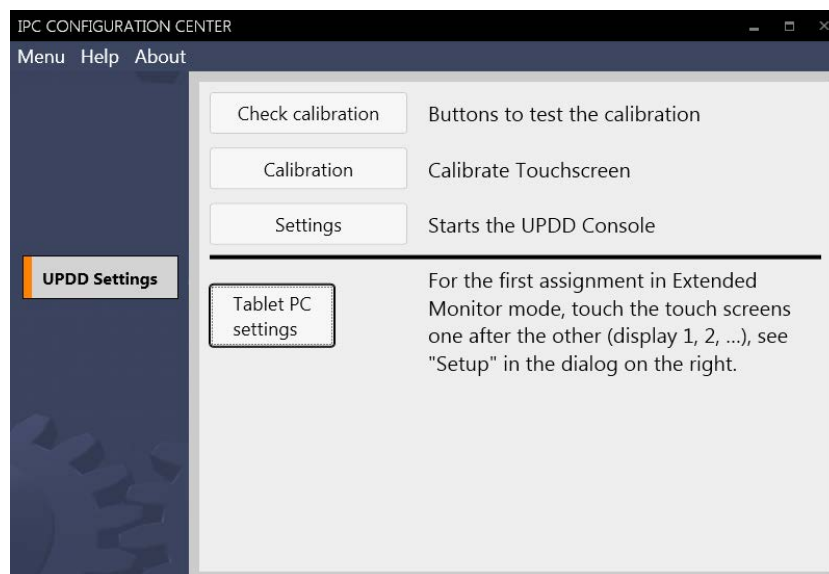

2. Click on the "Settings" button. The UPDD Console dialog box opens.

The "Hardware" tab shows the touch controllers of devices detected by the UPDD driver.

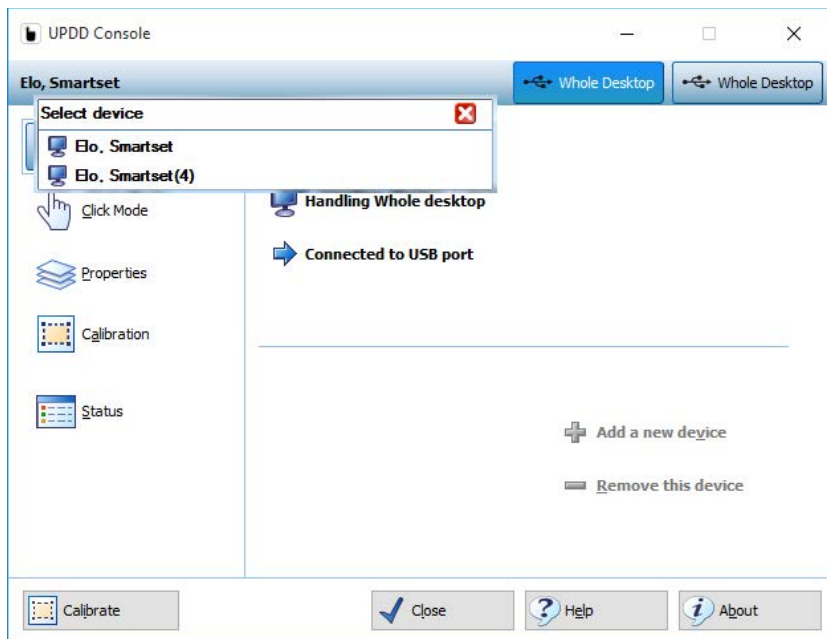

If you remove one of the devices recognized by the UPPD driver, the associated touch controller is marked red.

In the following example the connection to the device with the "Elo.Smartset(4)" touch controller was removed.

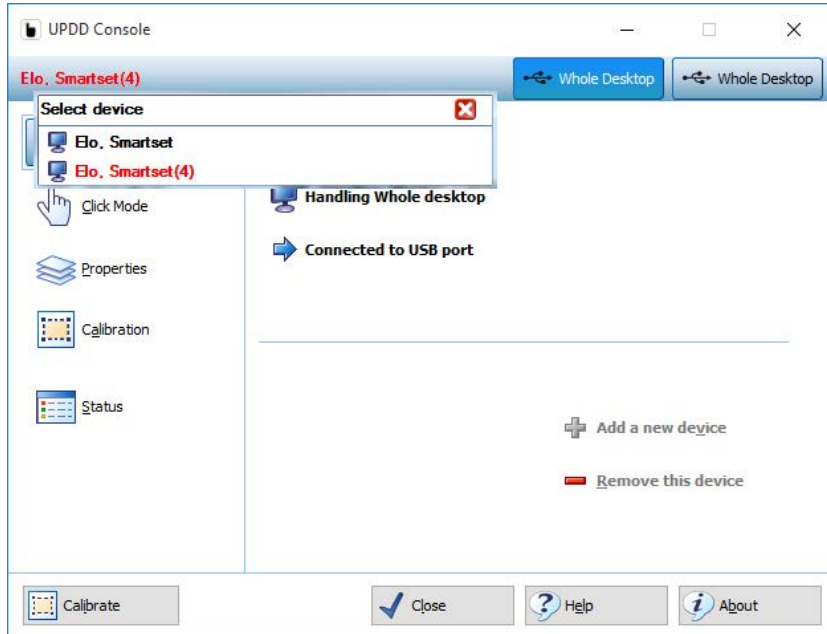

If you reconnect the device with the "Elo.Smartset(4)" touch controller, the "Elo.Smartset(4)" entry is highlighted in black again.

If you no longer need the device with the "Elo.Smartset(4)" touch controller, you can select the touch driver and remove it by using the "Remove this device" button.

### 3.7.2 Notes on clone mode

In clone mode, all screens of the connected devices show the same content.

The touch screen is secured by means of an interlock mechanism in clone mode; this mechanism prevents incorrect operations due to simultaneous operation.

#### Introduction

If you have connected two or more touch screens, which are operated spatially separate from one another, two operators can use the same application simultaneously. You use the interlock to prevent reversing an input made by Operator1 through Operator2: A touch operation blocks the operation on all other devices for some time that is reset with each new touch operation.

#### Procedure

1. Open the "UPDD Settings" dialog.
2. Click the "Settings" button.
3. Select "Properties > Priority > Interlock".
4. Enter a value > 0 for the timeout "Release Time". The default value is "5 s".

#### Disabling the interlock

To disable the interlock, set the value "0" for the "Timeout".

### 3.7.3 Calibrate touch screen

The touch screen of the device is pre-calibrated (3-point calibration) in the delivery state. The following two calibration types are available to recalibrate the touch screen:

- Standard 3-point calibration:  
The calibration data are stored in the EEPROM on the device.
- Advanced calibration with up to 25 calibration points, recommended if there are special requirements for accuracy:

The calibration data are stored in the operating system on the PC.

### 3.7.3.1 Standard calibration

#### Procedure

1. Open the "UPDD Console" dialog.
2. Select the touch controller of the device you want to calibrate in the header of the dialog.

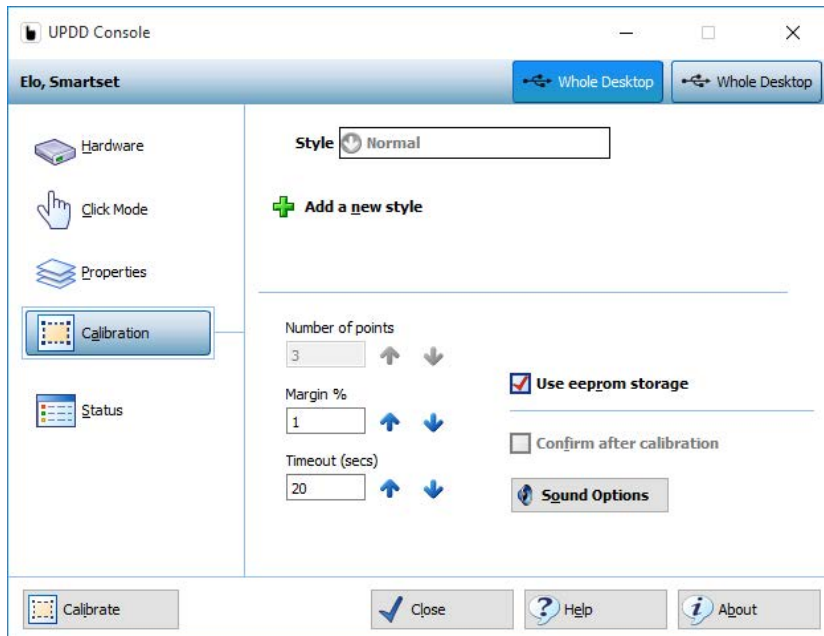

3. Click the "Calibration" tab.
4. Activate the option "Use eeprom storage". For Touch Controllers with EEPROM, the option box is pre-selected.  
The option box "Number of points" shows "3-point calibration".
5. Click the button "Calibrate".  
The calibration screen is displayed in the selected display.
6. Quickly touch the corresponding selections one after the other.  
The entry is confirmed by a check mark, the next selection is displayed.
7. Confirm all input prompts (arrows, or crosses in the center) until the complete screen has been calibrated.

---

#### Note

If the screen does not respond to touch as expected, check the controller selected under "1." in "UPDD Console" and repeat the calibration. Only an active touch controller can be calibrated. A removed touch controller is displayed in red.

If the accuracy of this 3-point calibration is not sufficient, you can clear the "Use eeprom storage" option box and use the extended 25-point calibration instead.

---

### 3.7.3.2 Extended calibration

#### Procedure

1. Open the "UPDD Console" dialog.
2. Select the touch controller of the device you want to calibrate in the header of the dialog.

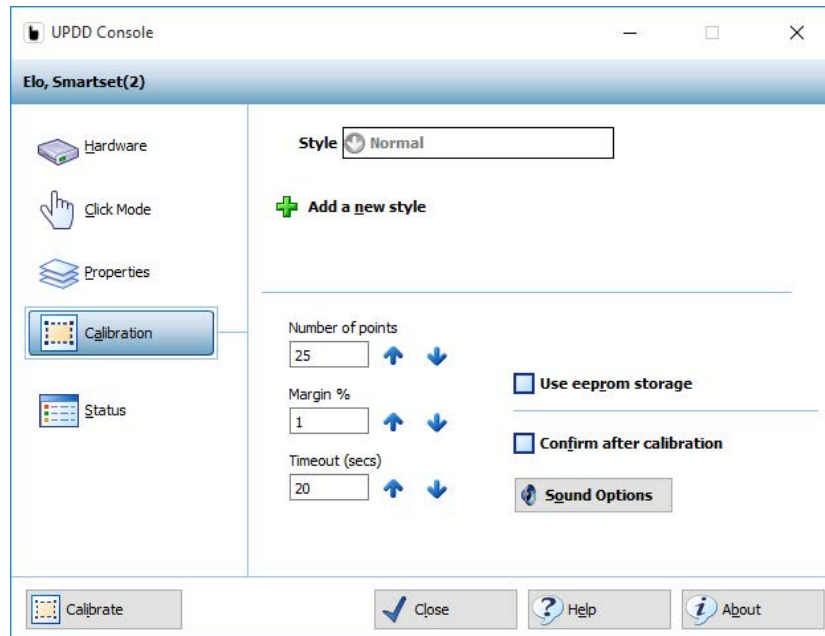

3. Click the "Calibration" tab.
4. Deactivate the option "Use eeprom storage".
5. Enter the value "25" under "Number of points".
6. Click the button "Calibrate".  
The calibration screen is displayed in the selected display.
7. Touch the corresponding selections one after the other.  
The entry is confirmed by a check mark, the next selection is displayed.
8. Confirm all input prompts (arrows, or crosses in the center) until the complete screen has been calibrated.
9. Finally, press "Confirm" for the input prompt.

### 3.7.4 Touch functionality

#### 3.7.4.1 Deactivate touch functionality

##### Procedure

1. Open the "UPDD Console" dialog.
2. In the header of the dialog, select the touch controller you want to deactivate.

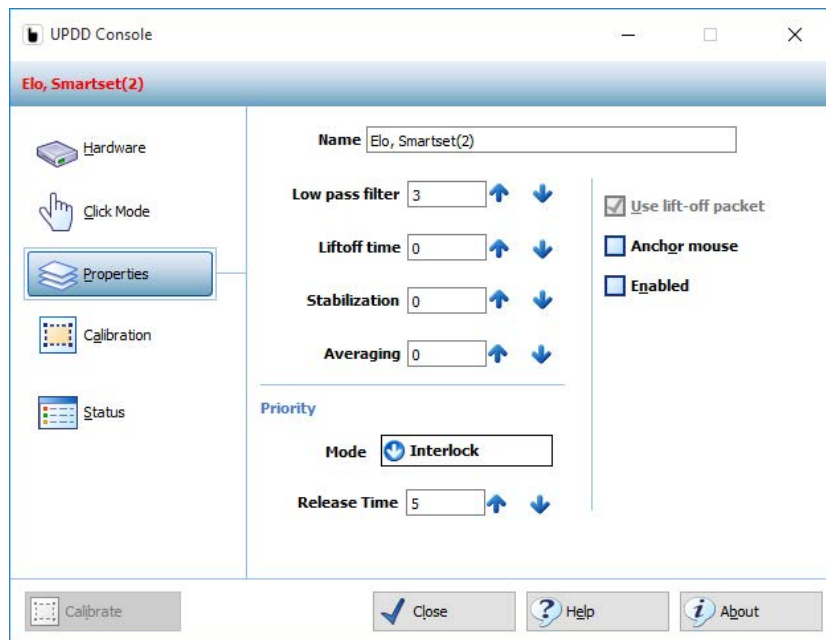

3. Select the "Properties" tab.
4. Deactivate the "Enabled" option.

The controller is deactivated.

---

##### Note

If you close the dialog box using "Close", the touch functionality remains deactivated.

If you have not connected a mouse, you can also reactivate the touch panel by means of a keyboard entry. Restart the "UPDD Console" via the start menu.

The keyboard entry <Alt+p> opens the "Properties" tab. Then the touch panel can be reactivated by entering <Alt+n>. (Option button "Enabled")

---



### 3.7.4.2 Extended Touch touch functionality

#### Procedure

1. Open the "UPDD Console" dialog.
2. Select the touch controller of the device you want to activate the extended touch functions for in the header of the dialog.

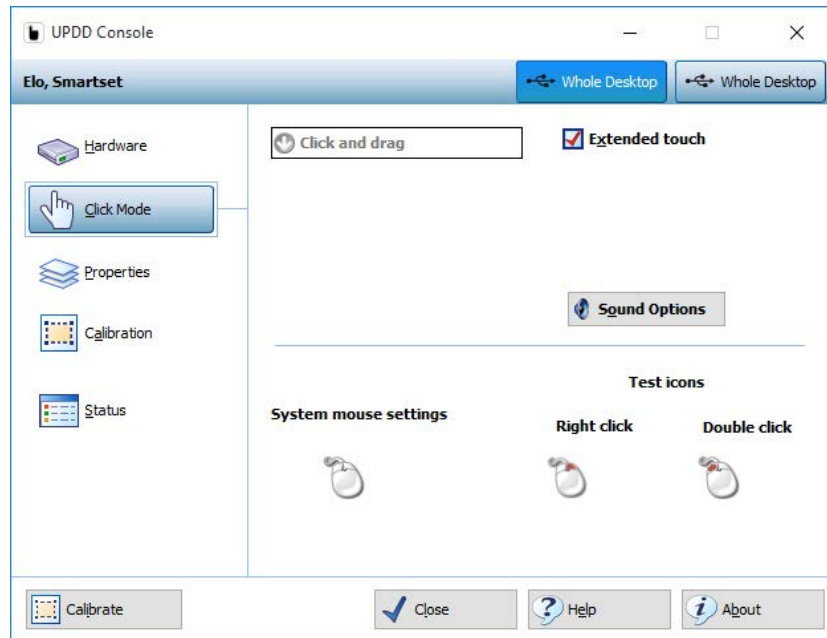

3. Select the "Click Mode" option.
4. Activate the option "Extended Touch".

---

#### Note

"Extended touch" is not available for the operating system WES7E.

If "Extended touch" is activated, the extended touch functions of Windows 7 are also available, such as permanently touching the touch screen, which corresponds to the right mouse button function. In addition, a virtual screen keyboard is automatically opened for the Windows logon and when input boxes are activated.

---

### 3.7.4.3 Touch in Extended Monitor mode

In Extended Monitor mode you can operate a PC with several touch devices.

#### Requirement

- All touch devices are connected to the PC.

## Procedure

In the following description of setting up Extended Monitor mode, one touch device is used in portrait format and one touch device in landscape format. The description can also be applied for touch devices in landscape format.

1. Open the Windows display settings with "Start > Control Panel > Appearance and Personalization > Display > Change display settings". The following dialog is displayed (illustration similar):

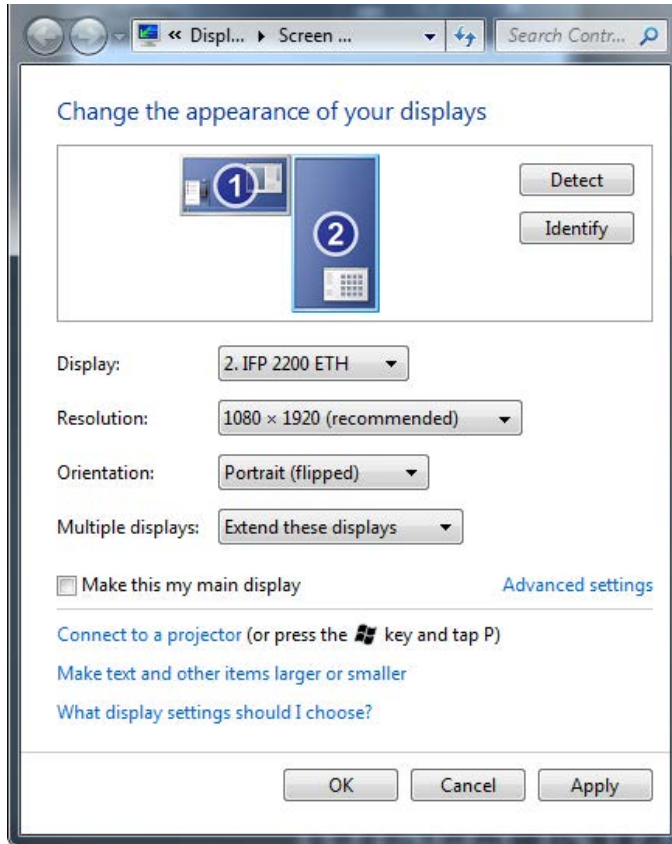

2. Set the resolution and orientation of the connected touch devices:
  - Select a screen resolution under "Resolution".
  - In the "Orientation" input box, select the entry "Landscape" or "Portrait (flipped)".
3. Close the dialog with the "OK" button.

4. Open the "UPDD Console" dialog.

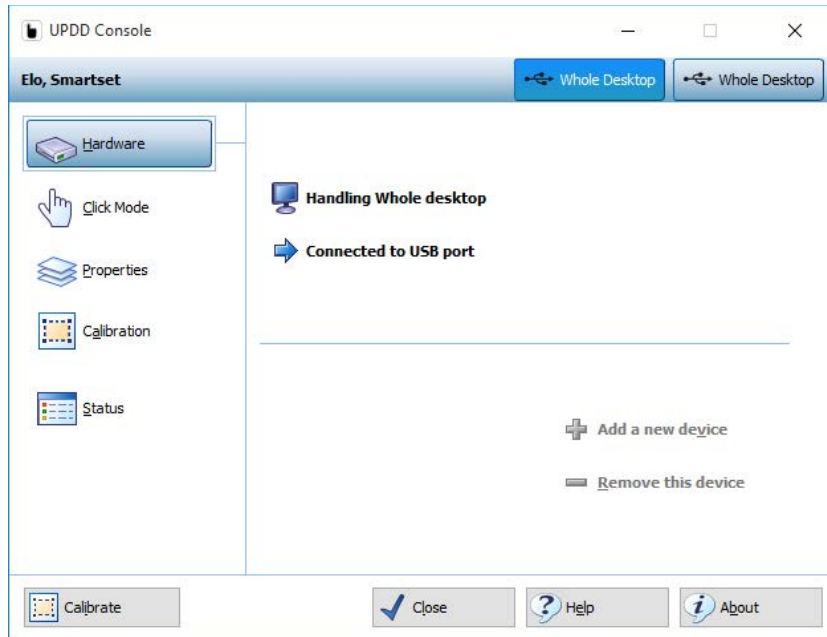

5. Click the "Hardware" tab.
6. Click "Handling Whole desktop".

The "Desktop Area" dialog box opens.

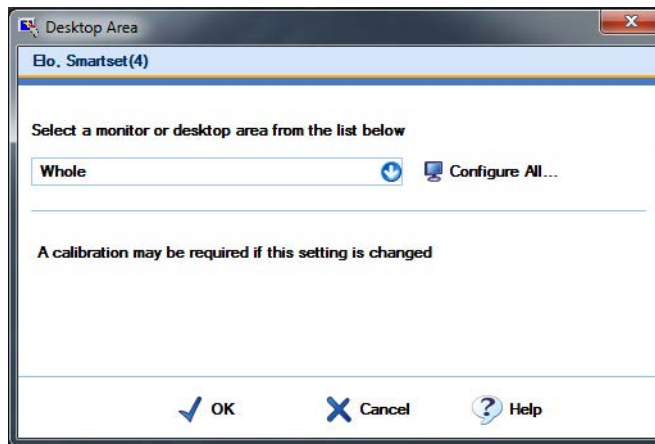

7. Click "Configure All ...".

You are prompted to touch the touch screens of the connected touch devices one after the other.

When you are finished, the UPDD driver includes the assignment of the monitors to the corresponding touch screens.

8. Calibrate the touch screens of the touch devices one after the other. All touch devices must be calibrated with an extended calibration of at least 9 points. A description of the calibration procedure is available in chapter "Extended calibration (Page 39)".

---

**Note**

**Touch assignment**

You can operate 3 touch devices in Extended Monitor mode. If 2 touch devices are in Clone mode, the first two monitors should always be duplicated (main monitor); otherwise, the touch assignment will be lost.

- In this case, operate touch device 1 and touch device 2 in Clone mode and touch device 3 in Extended Monitor mode.
  - If you change something generally on the monitor, e.g. the resolution and orientation, or use it as a main monitor, you have to assign the physical touch devices to the respective monitors again.
- 

**Note**

**Assignment: Extended monitor mode with two or more screens**

To extend the desktop to include all connected touch devices, you must assign the physical touch devices to the respective monitors under Windows for the first time:

1. Restart the computer.
  2. Connect an external keyboard to the PC.
  3. Repeat steps 4 to 7.  
You will see a white screen with a prompt. Touch this screen to identify it as touch screen.
  4. Touch the touch screens one after the other (number 1, 2,... in the display), two times each, and exit using any key on the external keyboard.
  5. For touch devices in Clone mode, the white screen is displayed on both monitors simultaneously. Touch the left touch screen, for example.
  6. Check whether the touch assignment to the individual touch devices is correct and the touch screen can be operated. If this is not the case in Clone mode, repeat the assignment starting with step 3 and select the right touch screen in step 7.
-

# Technical support

## A.1 Service and support

You can find additional information and support for the products described on the Internet at the following addresses:

- Technical support (<https://support.industry.siemens.com>)
- Support request form (<http://www.siemens.com/automation/support-request>)
- After-sales information system for SIMATIC PC / PG (<http://www.siemens.com/asis>)
- SIMATIC Documentation Collection (<http://www.siemens.com/simatic-tech-doku-portal>)
- Your local representative  
(<http://www.automation.siemens.com/mcms/aspa-db/en/Pages/default.aspx>)
- Training center (<http://sitrain.automation.siemens.com/sitrainworld/?AppLang=en>)
- Industry Mall (<https://mall.industry.siemens.com>)

When contacting your local representative or Technical Support, please have the following information at hand:

- Order number of the device (MLFB)
- BIOS version (industry PC) or image version (HMI device)
- Installed additional hardware
- Installed additional software

### Tools & downloads

Please check regularly if updates and hotfixes are available for download to your device. The downloads are available on the Internet under "After Sales Information System SIMATIC PC/PG" (see above).

## A.2 Troubleshooting

### Ethernet Monitors

Error pattern	Possible cause	Possible remedy
The Windows Start screen is not visible and only the extended desktop is displayed. The device cannot be operated.	Occurs when uninstalling the Ethernet Monitor software in combination with an Ethernet Monitor.	Uninstalling cannot be performed with an Ethernet Monitor. Use a different monitor for uninstalling.
IPC Wizard does not find a suitable device and aborts the installation.	Occurs during commissioning of a SIMATIC IPC with pre-installed IPC Wizard.	Acknowledge note text. Reboot. After rebooting, start setup of the Ethernet Monitor software.

Commissioning of the Ethernet Monitor software has failed.	Device has already been used in a different constellation	Factory setting must be restored on the devices. Re-install original PC operating system, use the Restore DVD for an IPC.
	Installation was started using a WLAN network connection.	WLAN is not supported, disable the WLAN adapter of the PC prior to installation.
A connection to the Ethernet Monitor was not established.	Make sure that the factory settings have been restored for the Ethernet Monitor.	<p>Switch off the power supply of the Ethernet Monitor. Press the Reset button and keep it pressed for another 10 seconds while switching on the power supply. Both LAN LEDs will go out briefly.</p> <p>You can check a reset of the Ethernet Monitor with a PC on which the Ethernet Monitor software was not installed.</p> <ol style="list-style-type: none"> <li>1. Set the network address of the PC to 192.168.1.1.</li> <li>2. Connect IPC and Ethernet Monitor via the network.</li> <li>3. Open the command line interpreter on the PC: "Start &gt; command prompt &gt; 'CMD'"</li> <li>4. Enter "ping 192.168.1.2" in the command-line interpreter. When a feedback message from "192.168.1.2" is displayed, the factory settings have been restored for the Ethernet Monitor.</li> </ol>
The start screen of the Ethernet Monitor remains in "Connected" state, text is green.		<ol style="list-style-type: none"> <li>1. Switch off of the power supply of the Ethernet Monitor and of the PC.</li> <li>2. Wait for 10 seconds.</li> <li>3. Switch on the power supply of both devices again.</li> </ol>
The Ethernet Monitor is not detected after the exchange of the Box PC.	The new Box PC was commissioned with no Ethernet Monitor. Therefore, no Ethernet Monitor was detected and the PDT ETH software was not installed.	<ul style="list-style-type: none"> <li>• Store the PDT ETH software in a local directory on the Box PC, so that it can be subsequently installed on site.</li> <li>• Or commission the new Box PC with an Ethernet Monitor.</li> </ul> <p>After the installation of the PDT ETH software, a connected Ethernet Monitor will also be detected.</p>
After a restart the operation on all connected IFP Ethernet monitors is sporadically not possible.	Input on the touch devices too soon after the restart	The "EMTouchSync.exe" program prevents this error screen by locking the input on the touch devices for a specific period after a restart (see the following section).

## A.3 Touch input locked by EMTouchSync.exe

### Purpose

The "EMTouchSync.exe" prevents that the operation is sporadically not possible after a restart (see error pattern in previous section). To do this the program blocks input on the touch devices for a specific period.

### Function

When the program is opened during the login it places a virtual desktop over all connection screens and prevents touch input. All desktops are unlocked again at the end of the specific waiting period. The program is started via the Windows 7 Task Scheduler

### Storage location of the file

File path "C:\Program Files (x86)\Siemens\Automation\ICC\EMTouchSync.exe"

### Requirements

- Only with connected IFP Ethernet monitors
- Windows 7 operating system on the PC
- PDT ETH software is installed on the PC.
- In the shortcut menu of the Desktop, "Extend this display" is set at "Screen resolution > Multiple displays".

### Call parameters

The following parameters are transferred and stored in the registry when the command line is called:

To test the program, start command line input via the Windows Start menu "Start": Enter a password in the "cmd" text box.

### Parameter [WaitTime]

Value	Explanation
1 to 200	Valid values for the waiting time in seconds
30 - 40	Recommended values for one or two IFP Ethernet monitors
40 - 50	Recommended values for maximum of three IFP Ethernet monitors

Example of command line call: `EMTouchsync.exe 40` locks the Desktop for 40 seconds.

### Parameter [Dialog]

Value	Explanation
on   off	During the waiting time, displays a corresponding message on the IFP Ethernet monitors ("on") or not ("off").

Example of command line call: `EMTouchsync.exe 40 on` locks the Desktop for 40 seconds and at the same time displays the message "Please wait".

### Parameter [/?]

Value	Explanation
on   off	Displays the current program version and its parameters

Example of command line call: `EMTouchsync.exe /?`

### Integration in the Task Scheduler

The Task Scheduler is used to set the time for the start of the program:

1. In the Windows Start menu, select "Start > All programs > Accessories > System programs > Task Scheduler".
2. Open the "Task Scheduler library".
3. In the "Actions" window, right-click on "Create task".
4. In the "General" tab, enter "EMTouchSync" under "Name".
5. Open the "Trigger" tab.
6. Click "New". The "New trigger" dialog opens.
7. Under "Start task", select "At logon".
8. In the "Settings" area, select the option "Specific users" and click "OK" to close the dialog.
9. Open the "Actions" tab.
10. Click "New". The "New action" dialog opens.
11. In the "Settings area", select the file path under "Program/Script" (see section "Storage location of the file").
12. Type a valid command line call in the "Add arguments" field (see "Parameters" sections) and click "OK" to close the dialog.
13. Open the "Settings" tab.
14. Clear the option "Close task if it executed for more than".
15. Click "OK".

The task is saved. When you log on to the PC, "EMTouchSync.exe" starts and locks the touch input of all connected IFP Ethernet monitors for a specific waiting period.